

OpenEx User's Guide

DT

OpenEx User's Guide

Copyright

© 2000-2012 Tucker-Davis Technologies, Inc. (TDT). All rights reserved.

No part of this manual may be reproduced or transmitted in any form or by any means, electronic or mechanical, including photocopying and recording, for any purpose without the express written permission of TDT.

Licenses and Trademarks

Windows 7 is a registered trademark of Microsoft Corporation.

Updated: 2/13/2012 11:07 AM

Table of Contents

Before You Begin	1
OpenEx Overview.....	3
About OpenEx.....	5
Real-Time Control	6
Bridging the Gap	7
The Client/Server Environment.....	7
OpenEx Tutorials	9
Tutorial 1: Getting Started with OpenEx	11
Tutorial 2: Store Pooling	33
Additional Standard Project and Example Files.....	43
OpenProject Reference	47
About OpenProject.....	49
About the OpenProject Window.....	49
Creating a Project	50
About the OpenProject Configuration Window	51
Adding Applications to an Existing Project	53
Changing Launch Settings.....	53
Stop Making Local Copies of RpvdsEx Files.....	54
Working with Data Tanks in OpenProject.....	54
Importing Application Files.....	55
Menus and Dialog Boxes	56
Circuit Design Reference	61
Circuit Design Overview.....	63
OpenWorkbench Reference.....	77
About OpenWorkbench.....	79
Understanding OpenEx Data Stores.....	80
About Epoch Events	81
About Tanks	82
Workspace Basics.....	83
Configuring an Experiment	94
OpenController Reference.....	113

About OpenController	115
About Visualization Tools.....	115
About Modifiers	116
Understanding Targets	116
Controlling the Experimental Protocol	118
Workspace Basics.....	119
Control Types.....	129
Linking Controls	184
Control Settings Reference.....	189
OpenScope Reference.....	223
About OpenScope.....	225
About Adding Plots	225
About Plot Settings	226
Using Epochs with OpenScope	228
Workspace Basics.....	230
Plot Types	239
Plot Settings Reference	260
OpenBrowser Reference	269
About OpenBrowser.....	271
Workspace Basics.....	271
Data Selection.....	274
Data Browsing.....	278
Data Export	282
TTank Reference	299
The Tank Monitor Workspace.....	301
Accessing a Tank on Another PC	303
Appendix A – Non Macro Circuit Construct Reference	313
Overview	315
Control Constructs	318
Data Storage	330
Instantaneous Rate Construct	346
OpenController Constructs	347
Appendix B – Tips, Tricks, and Technical Information.....	349
Connecting the Hardware	351

Tips for Working in OpenEx	352
OpenEx Cheat Sheet	353
Clean Running Applications	355
Optimizing Performance for High Data Transfer Rate Operation	357
Working with Long Blocks	357
FAQs	359
Known Anomalies.....	361
Resolved Anomalies	363
Troubleshooting.....	365
Glossary.....	367
Index	373

Before You Begin

Installation

The OpenEx Suite can be installed from the TDT Installation CD or downloaded from the TDT website. Always uninstall old versions before installing a new version of OpenEx. TDT Drivers should be installed before installing OpenEx.

The recommended operating system for all TDT systems is Windows 7®.

Hardware Requirements

The OpenEx suite supports all System 3 processors, however RX or RZ High Performance Processors and Optibit PC Interface are recommended for most applications.

See the System 3 Installation Guide for hardware installation and set-up instructions.

Organization of the Manual

This manual will help you get started using OpenEx software and serve as a long-term source of reference information

In the OpenEx User's Guide you will find:

Overview

The overview briefly describes the OpenEx applications, how they work together, and important OpenEx concepts.

Getting Started with OpenEx – A Tutorial

The step-by-step *tutorial* provides an introduction to many important OpenEx concepts and techniques.

Reference Guides

A reference is provided for each component of OpenEx. Reference guides include step-by-step instructions for basic tasks, and detailed references for windows, menus, dialog boxes, and settings.

Tips, Tricks, and Technical Information

If you can't find it anywhere else, maybe you can find it here. The tips, tricks, and technical information section provides answers to commonly asked questions and revisits important OpenEx concepts.

OpenEx Overview

About OpenEx

The OpenEx Software Suite is a powerful experimentation platform that provides researchers with flexibility and configurability found in no other commercial system. OpenEx includes several client and server applications for the System 3 hardware platform. The diagram below illustrates the relationship between OpenEx clients and servers and further discussion of each role follows.

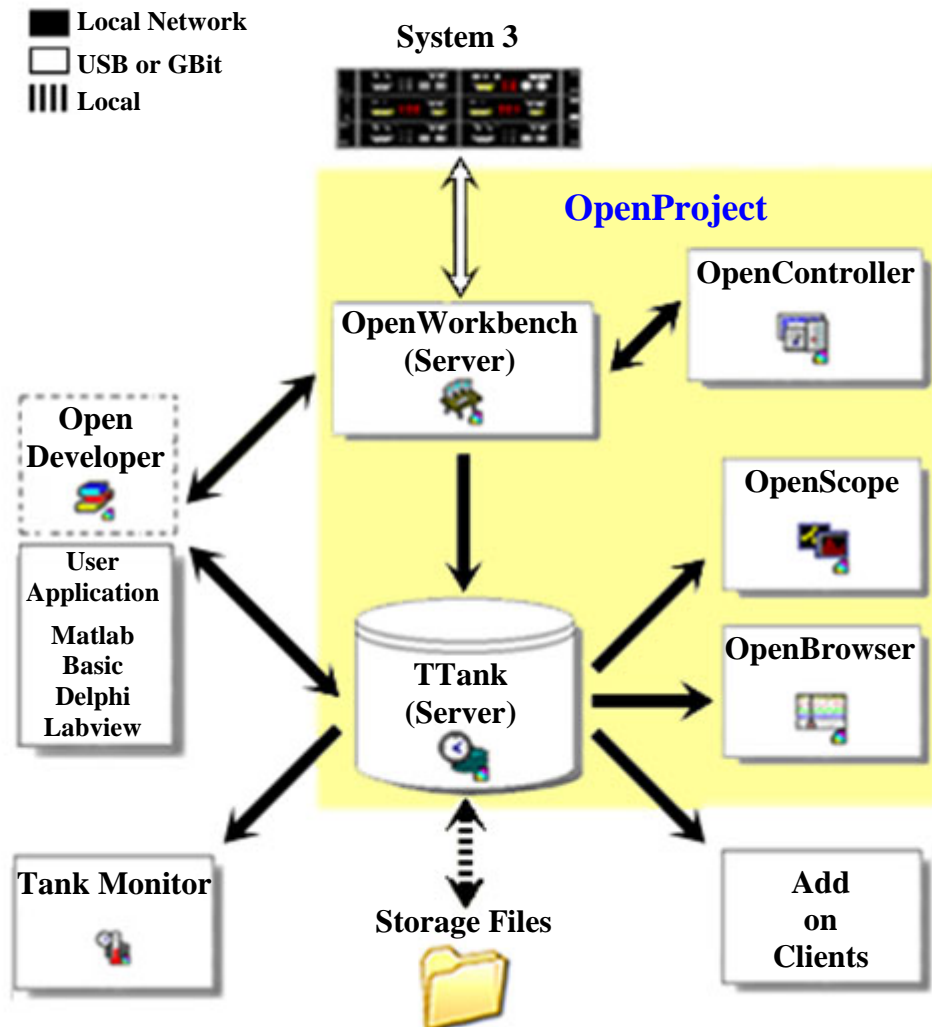

OpenEx Client Server Diagram

System 3 is the flexible hardware platform accessed through the OpenWorkbench application. System 3 real-time processors are programmed via compiled circuit files designed using TDT's RPvdsEx software and assigned, loaded, and run by the OpenWorkbench hardware server.

OpenWorkbench serves double duty as both a client application and a hardware server. All communication with the System 3 hardware occurs through OpenWorkbench. By working directly in OpenWorkbench the user can provide instructions about the experimental protocol to the hardware. Client programs such as OpenController or applications developed with OpenDeveloper may also be used to request information about the hardware or pass instructions to the hardware through OpenWorkbench.

TTank is the database server and can store and provide data to many applications in real-time during an experiment or offline for post-hoc analysis of data. OpenWorkbench provides acquired data and instructions about storage to TTank. Data is stored in files on the computer where TTank is running. Client applications such as OpenScope and OpenBrowser request data from the tank and present it to the user in the desired format. OpenDeveloper can also be used to create custom client applications that may request data or provide instructions for data storage.

Storage files are created by the TTank data server according to information configured by the user through OpenProject or the OpenWorkbench application.

Tank Monitor provides quick and easy access to the TTank data server. Users can view information about TTank activity or perform basic maintenance such as adding or removing tanks.

OpenController is a visual interface that allows users to control experimental parameters (such as filter settings, threshold settings for unit activity, and stimulus presentation variables) and access acquired data and parameter variables in real-time. OpenController accesses the hardware through the OpenWorkbench Server.

OpenScope is a user-customizable display and analysis application. The TTank data server sorts and serves data to the OpenScope plots, which are updated as each of the selected data tank elements becomes available. This means that stored data can be displayed dynamically during the course of an experiment, or that the entire experiment can be re-played later as if the data were just being acquired.

OpenDeveloper is a group of ActiveX controls that can be used with programming languages such as MATLAB, Visual Basic, and Visual C++ to generate client applications that access the OpenEx servers (TTank and OpenWorkbench).

OpenBrowser is a data export and viewing application that accesses data through the TTank data server. Data from one or more data tanks can be selected, previewed, and exported to a standard ASCII file format or formats for Plexon's *Offline Sorter* or *NeuroExplorer*.

Add on Clients TDT continues to develop client applications that can be added to the OpenEx core suite to round out functionality, including tools for data analysis such as OpenExplorer and OpenSorter.

Real-Time Control

Real-time control and precise timing control are critical to good experimental design. Traditionally, systems offering these important features have been built on fixed hardware/software platforms; as a result they are inflexible and cannot easily be expanded. TDT's System 3 real-time processors and RPvdsEx circuit design software address this traditional shortcoming by offering an easy to program development environment that allows users to customize the function of each processing device in their system.

TDT processors are controlled by circuits within a compiled circuit file (either .rco or .rcx format). Circuits designed for OpenEx include parameter tags that allow users to control timing, triggering, data storage, and modification of other parameter values. By utilizing these tags, OpenEx allows users to control the experiment in real-time. Users can send values to the tags from within OpenEx's user-friendly software environment.

Bridging the Gap

OpenEx represents TDT's latest advancements in software design. Traditionally there have been two approaches to developing software for the research environment: "turn-key" systems and custom systems. Over the years TDT has moved steadily towards bridging the gap between these two approaches. We've overcome many of the limitations of traditional turn-key software by developing some of the most flexible software available for many research applications. At the same time, we've continued efforts to develop an increasingly more user-friendly development environment for custom applications. OpenEx builds on the idea of flexible turn-key interfaces for experimental control and analysis and accommodates customization through the use of compiled circuit files.

What are compiled circuit files?

The foundation for each TDT system is a powerful hardware platform. System 3 hardware is built around real-time processing modules that include onboard digital signal processors. These processors are capable of conditioning, processing, and storing data in real-time and are controlled using circuits designed using TDT's RP visual design studio (RPvdsEx). Compiled circuit files (in either .rco or .rcx format) are files that contain 'control objects' that can be accessed by software applications like the OpenEx applications. The .rcx format is the standard format for compiled circuit files. This file type includes both the control object and the graphical circuit diagram in a single file.

Users can generate their own compiled circuit files for use with OpenEx or select one of the standard compiled circuit files provided by TDT. In RPvdsEx, circuits are designed in a drag-and-drop interface. After the circuit is designed, a compiled circuit file can be generated from a simple mouse click. This means that users can customize experiments in the OpenEx environment without any knowledge of programming. By supporting customization, all the way down to the signal processing functions being performed at the lowest levels, OpenEx offers power and flexibility not available in other systems.

To learn more about TDT System 3 hardware and RPvdsEx, see the System 3 Manual and RPvdsEx Manual.

The Client/Server Environment

OpenEx uses a client/server approach that enables the building of powerful software environments from a number of smaller applications. Individual applications can be developed to efficiently handle a set of tasks, such as visualizing data or exporting data, and can even run in parallel. For example, a data visualization application can interact with the data server where data is stored, managed, and served up to applications. One of the many benefits of this efficient approach is that a single server application can interact with several client applications. This means, for example, that a data server can effectively interact with both a data visualization application and a data export application or even several instances of each. Finally, OpenEx has been developed using a client/server protocol that allows applications to communicate effectively across networks. This means that the OpenEx applications can be distributed efficiently across different locations.

The Clients and the Servers

The OpenEx Suite currently includes two servers (TTank and OpenWorkbench) and five client applications (OpenWorkbench, OpenController, OpenScope, OpenBrowser, and Tank Monitor).

Data is stored in files on the computer where TTank is running and OpenWorkbench must be run from a computer with a direct connection to the hardware. Client applications can run from any networked computer. TDT does not limit installation of client applications. This means, for example, that several users can visualize experimental data on separate PCs as it's acquired. Several add-on client applications are also available such as OpenExplorer and OpenSorter.

The Client/Server Advantage

The client/server advantage allows a number of smaller applications to come together in one powerful OpenEx environment. With OpenProject, all OpenEx programs are brought under the control of a single management tool and all experiment files are managed automatically under a single directory structure.

OpenEx Tutorials

~

Tutorial 1: Getting Started with OpenEx

Getting Started with OpenEx is a hands on tutorial, in which you'll learn to design, create, and run an experiment in the OpenEx environment. This tutorial takes you through the process step-by-step while introducing important OpenEx concepts. The concepts and techniques introduced can be applied to any type of experiment. This tutorial will help users become more familiar with the OpenEx software suite.

In this tutorial you will:

1. Plan and create an OpenEx project.
2. Design a processing chain and generate a compiled circuit file (*.rcx format)
3. Build the OpenWorkbench experiment.
4. Add a real-time filter control using OpenController
5. Visualize and store data using OpenEx.

The project in this tutorial will acquire and store two channels of filtered data and display the acquired data streams in real-time. A filter control will allow real-time adjustment of low pass and high pass corner frequencies in OpenController.



Keep an eye out for key OpenEx concepts. These concepts are extremely important when using OpenEx.

Planning the Project

When you plan a project you will need to:

1. Determine what type of data will be acquired.
2. Determine what device(s) you will use.
3. Determine which OpenEx applications you will need.

The Data

First, consider the type of data that will be acquired. In general, data can be categorized into three basic data types: scalar values, discrete waveforms (often called snippets or segments), and continuous waveforms (often called streamed data). This tutorial will acquire two channels of streamed data and a simple timing tick.

Typical streamed events include slow wave brain recordings, decimated multi-channel extracellular recordings, and any event that requires a chart recording of all or most of the data. In this case you'll be acquiring continuous waveforms generated digitally within the project for demonstration purposes.

The timing tick is a standard feature of many OpenEx Projects. A pulse will be generated and acquired once per second and stored as a set of scalar values.

The underlying programming (or circuit construct) for storing each type of data is different, but the RpvdsEx visual design tools you will learn about in this tutorial make it easy to choose the

correct circuit components to ensure that all data is stored and served up for display or analysis quickly and efficiently by OpenEx's TTank data server.

The Device

System 3 includes several real-time processor designs with a range of processing speeds, onboard memory, and input/output configurations, each tailored to support specific target applications. OpenEx supports all of the System 3 processor devices and this tutorial is designed to work with any processor. For possible hardware configurations see *Connecting the Hardware*, page 351 or the *Installation Guide* provided with your system.

The OpenEx Applications

OpenEx is a suite of applications that work in a client/server environment. That means you can pick and choose the applications you need to build and run your experiment. In this tutorial you will be building the project from the ground-up. To design the processing chain that controls the processor you will use RpvdsEx, the circuit design interface. To design the experiment and to handle communication between the OpenEx environment and the hardware you'll need OpenWorkbench. Finally, to design the real-time filter controls you will use OpenController.

Creating the Project

To help you manage multiple applications and the files associated with them, each experiment is created as a project. You can quickly create the project and generate all of the files associated with it using OpenProject. You can then access all of the project files by loading a single OpenProject (.wsp) file.

Note: Ensure that your TDT system is connected to the PC and turned on before creating the project.

To run OpenProject:



- Double-click the **OpenProject** icon on your desktop.

OpenProject is launched and you are ready to open an existing project or create a new one.

To create a new project:

1. In the OpenProject window, click the **OpenProject** menu and click **New Project**.

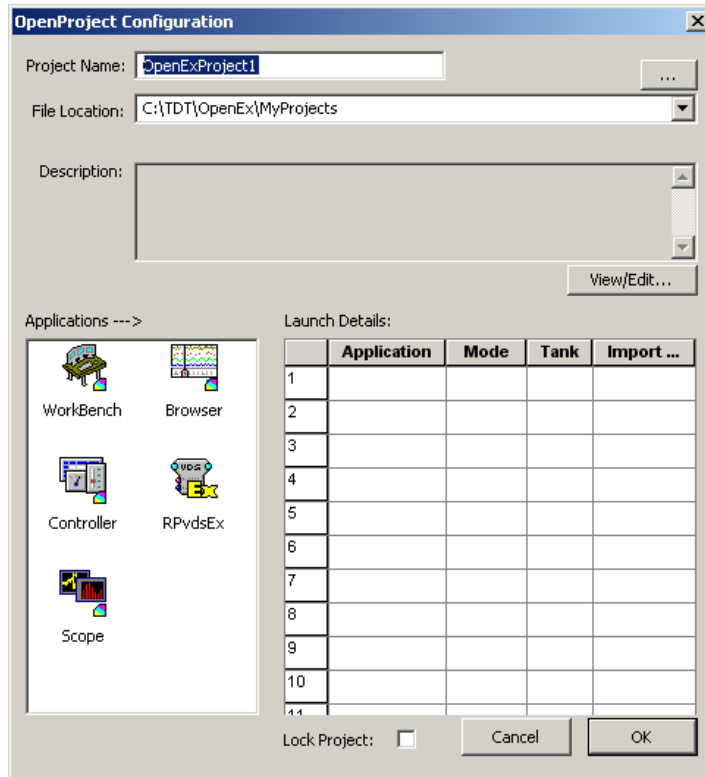

2. In the OpenProject Configuration window you can enter a project name and description. The project name will be used to generate a folder where all the project files will be stored.

In the **Project Name** box type **Tutorial**.

3. In the **File Location** box, the default location for new project directories, the My Projects folder, is displayed. We recommend keeping all your projects under this folder, so leave the File Location information as is.

Note: If the My Projects folder is not displayed, click the down arrow to select it from the drop down list or the **...** Browse button to locate it manually.

4. To add a description, click the **View/Edit** button, click the **Edit** check box, and type a description.

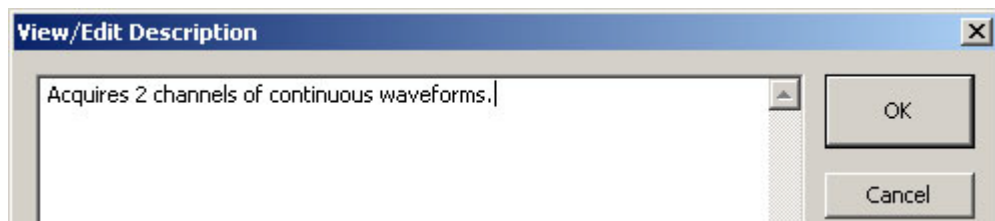

5. Click **OK**.

To add applications:

1. Double-click the **WorkBench** icon to add OpenWorkbench to the project.

The application is added to the Launch Details list.

2. Double-click the **RPvdsEx** icon to add one instance of RPvdsEx to the project.
3. Double-click the **Controller** icon to add one instance of OpenController to the project.

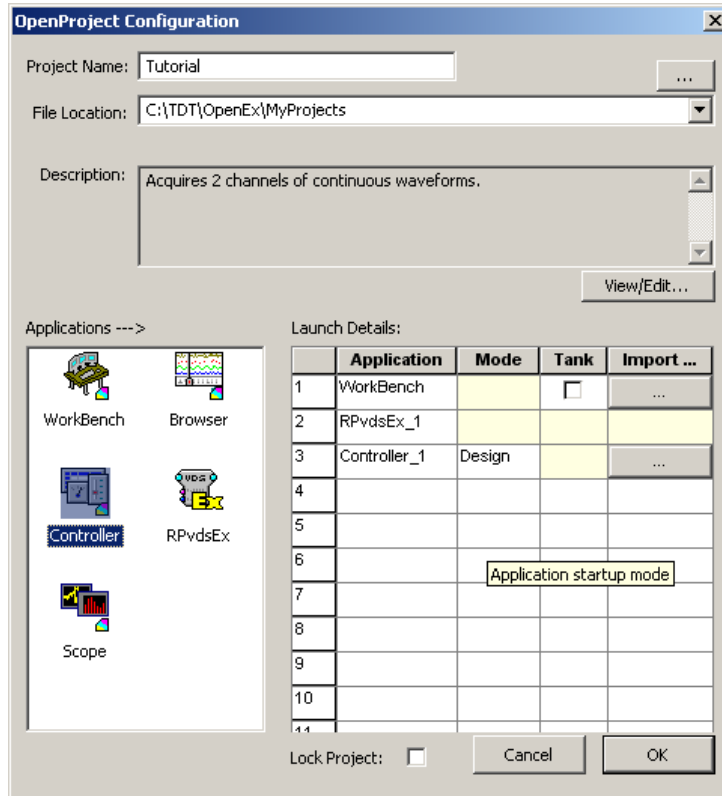

4. Click **OK** to close the OpenProject Configuration window.

As the applications are launched, an icon for each application is added to the OpenProject main window and associated application windows are stacked and attached to the OpenProject window. You can switch between applications by clicking the application's icon in the OpenProject window.

Designing a Processing Chain and Generating a Compiled Circuit File

Compiled circuit files, are the key to customizing your OpenEx experiment design. Because compiled circuit files are generated in the RPvdsEx drag-and-drop interface, you can customize experiments at the lowest level without any knowledge of programming. This tutorial illustrates just how simple it can be to design a project from the ground up. Follow along with these step-by-step instructions for building a simple macro-based OpenEx project to learn important circuit design concepts.

To select the circuit design application and create a new file:

1. Click the **RPvdsEx_1** icon in the OpenProject window.

The RPvdsEx applications window is brought to the top of the "stacked" windows that are

attached to the tall, narrow OpenProject window.

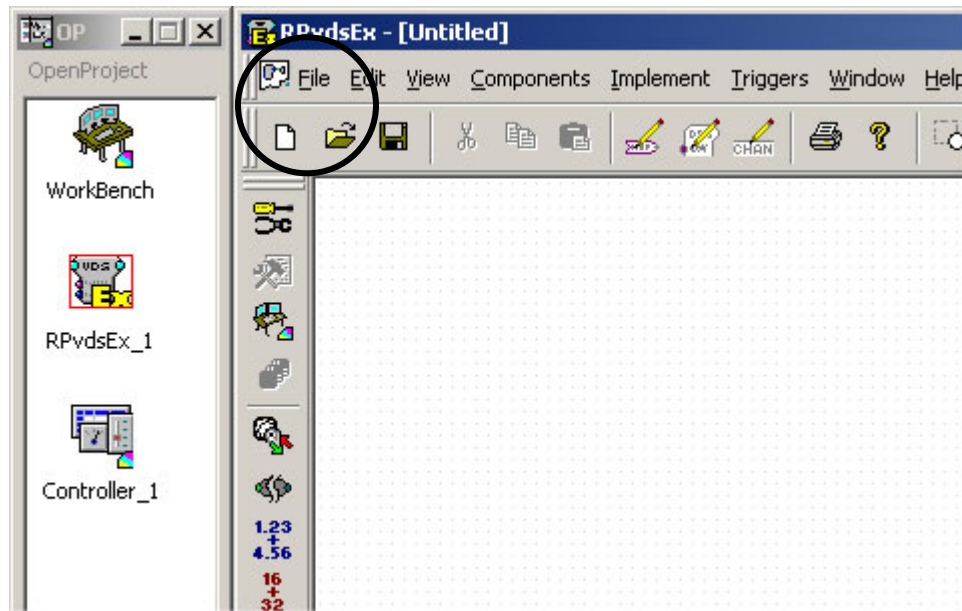

2. In the RPvdsEx window, click the **File** menu and click **New**.
You're ready to begin circuit design.

Adding Required Timing and Synchronization

Every project requires some basic timing and control elements. In OpenEx all the timing and control functions can be handled by the CoreSweepControl macro. Macros are a special construct that comprises a group of circuit components and allows you to configure those components and set their parameters through a simple, wizard like properties dialog.

The CoreSweepControl can handle a broad group of timing and control functions, but in this basic project it is primarily responsible for starting and synchronizing timing generators on each real-time processor in the OpenEx project and automatically distributing timing signals to all other macros that require them. Additionally, though not required, the CoreSweepControl will store the timing tick discussed at the beginning of the tutorial.





The CoreSweepControl macro or equivalent circuitry must be included in every OpenEx project.

To add a CoreSweepControl macro:

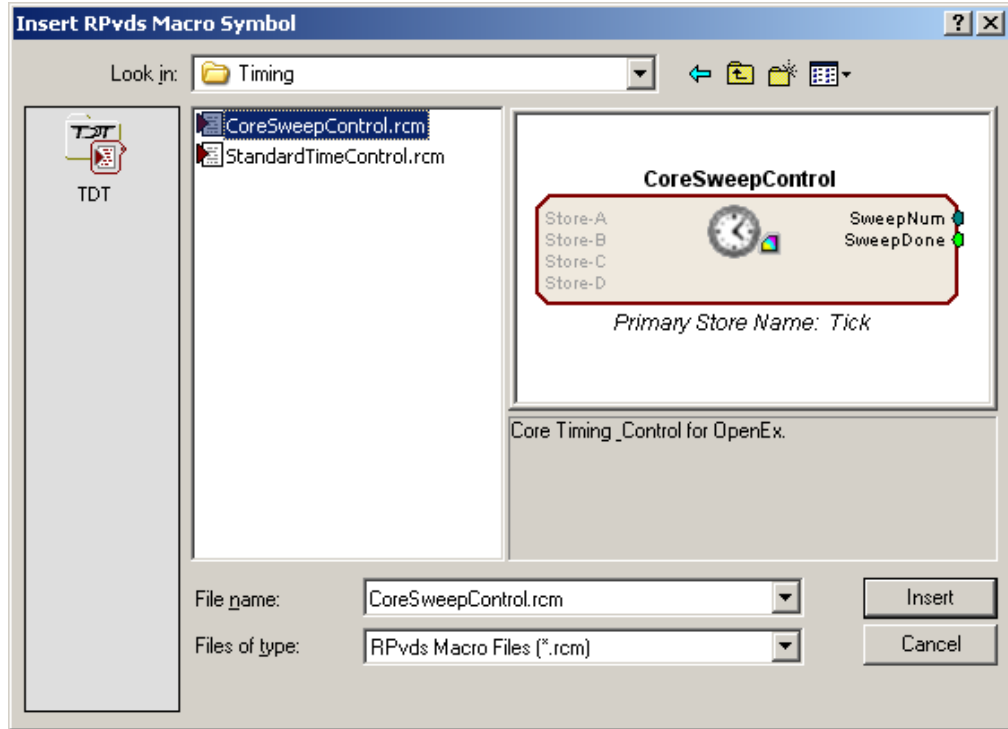
1. In RPvdsEx, click the  **Insert Macro** icon on the RPvdsEx Components toolbar.
2. In the dialog box, select the **CoreSweepControl** macro from the **Macros | Timing** folder.



Notice that symbols in the center of the icon indicate the class of macro  (timing) and whether or not it is intended for use with OpenEx  (used in OpenEx).

3. Click **Insert**. After the dialog box closes, click the workspace to place the component in the workspace.

You can double-click the macro icon to view parameter menus and full documentation for the macro. No changes to the default settings of the CoreSweepControl macro are necessary for this tutorial.

Adding Signal Acquisition

To illustrate the components required to store and display data, we'll acquire two channels of analog data directly from the output of RPvdsEx waveform generator components. These could later be replaced with A/D inputs to continuously acquire, display, and store two channels of external analog data.

RPvdsEx provides a variety of data storage macros and selecting the appropriate storage component for the type of data that is being acquired is extremely important. When browsing the macro folders in RPvdsEx, you'll find that the macros are organized into logical folders by type, such as streaming or Segment_Snip. Macro names are also designed to provide important information such as the number of channels (or MC for multi-channel macros that support higher channel counts). Selecting the macro in the browse window also displays a brief description you can use to make your selection.

Since we are working primarily with streaming data, a streaming storage component such as the Stream_Store_1-4Ch macro should be used.

1. Click the  **Insert Macro** icon, select the **Stream_Store_1-4Ch** macro (from the Macros | Data Saving | Streaming folder), click **Insert** then click the workspace to add the macro.

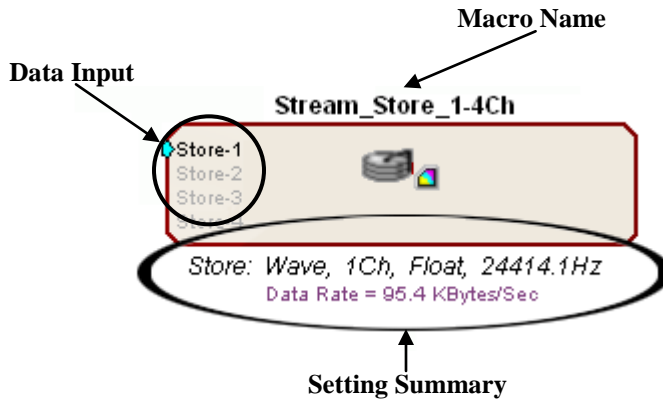

Notice that the macro displays key settings along the bottom edge of the icon. The macro name is displayed above and the Store or data inputs are located along the left edge of the icon. By default, only one channel is enabled when a Sream_Store_1-4Ch macro is added. Additional inputs will be activated based on settings within the macro.

2. Double-click the macro to access the macro documentation and setup menus.

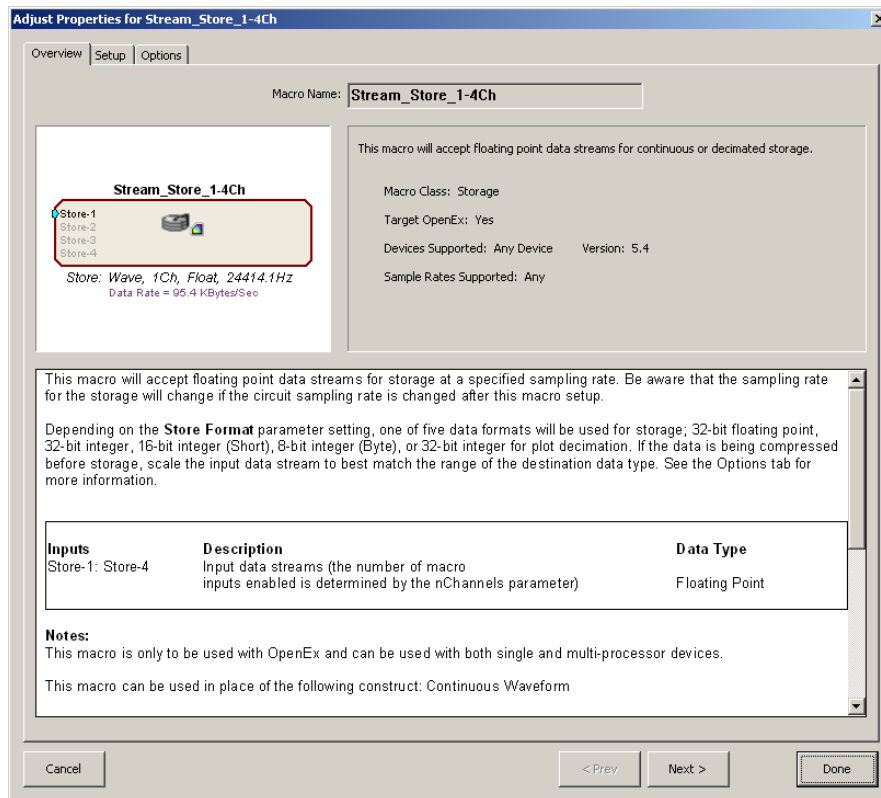

The Overview page of the properties dialog provides summary information and general documentation. Subsequent tabs include both settings and documentation.

3. Click the **Setup** tab or click **Next**.

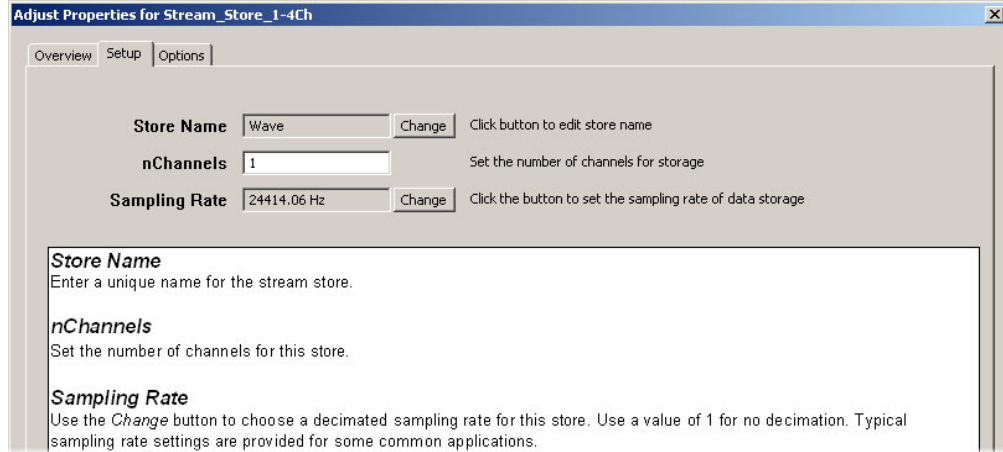

- To set the macro to acquire two channels of data, set the **nChannels** value to **2**.



Notice the Store Name field. In OpenEx, each type of data to be stored is called a *Store* and is given a unique name used to identify it in the data tank.

- To change the default name of the Store (*Wave*), click the **Change** button next to the Store Name, type *Demo* in the pop-up dialog, and click **OK**.
- Click the **Options** tab or click **Next** to continue. On the Options tab you can select a storage format from a drop-down list and set a scale factor. For this example, leave the format of the stored data in the default floating-point (32 bit) format. Other options include Integer, Short, Byte, or PDec.
- Finally, click **Done** at the bottom of the properties dialog.

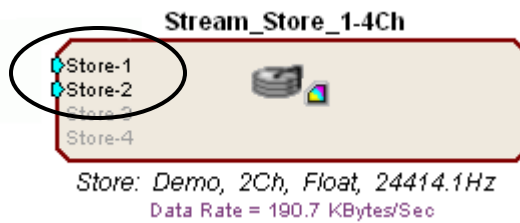

The Stream_Store_1-4Ch macro should now display two active inputs on the left side of the icon.

Adding Signal Filtering

To add signal filtering:

- Click the  Insert Macro icon, select the HP-LP_Filter_4Ch macro (from the Macros|Filtering folder), click Insert then click the workspace to add the macro.

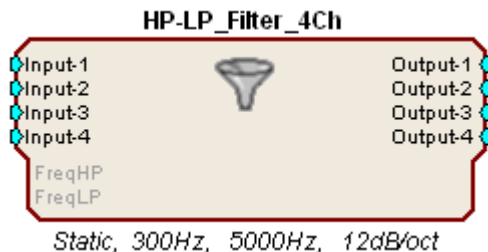

By default, many macros contain a field which allows the number of channels to be specified. This is useful for reducing unnecessary components and disabling unneeded inputs and outputs. The HP-LP_Filter_4Ch macro was chosen to illustrate this concept and also to keep the circuit as simple as possible.

2. Double-click the macro to access the macro documentation and setup menus.

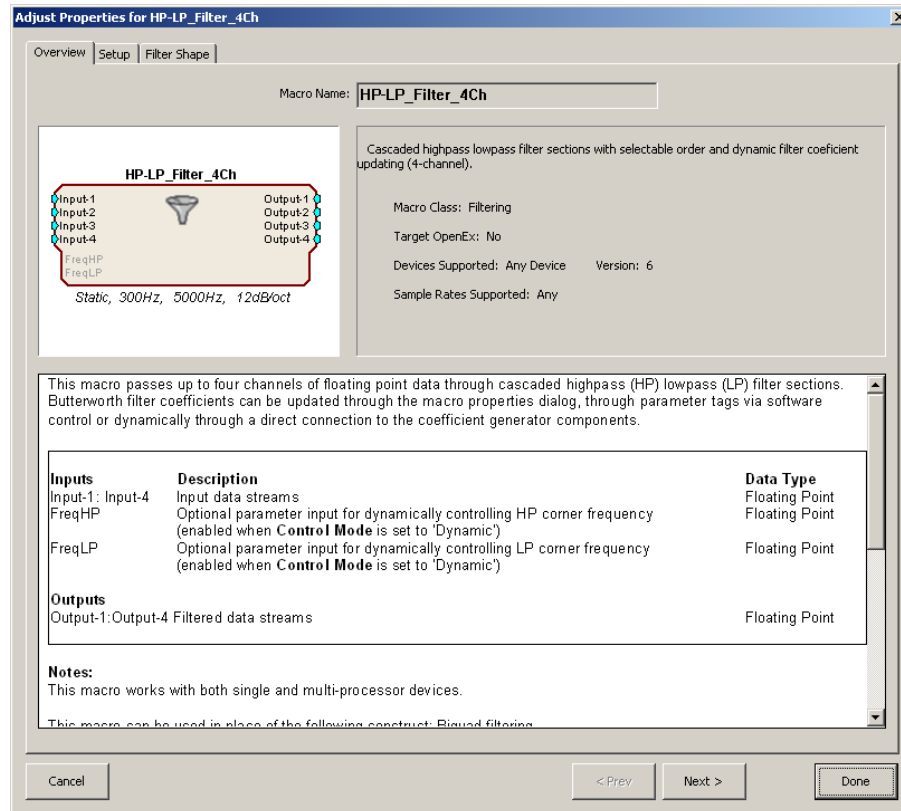

3. Click the **Setup** tab or click **Next**.
4. To set the macro to allow for real-time control to be added later, select **Access Tags** from the **Control Mode** drop down box. This option allows parameter tags to be assigned as targets for real-time control in OpenController based upon the **Tag Name** field in the macro setup menu.
5. Click the **Filter Shape** tab or click **Next**.
6. To set filter shape, enter **2** in the **Highpass Frequency** text box.
7. Enter **1000** in the **Lowpass Frequency** text box.
8. Click **Done** at the bottom of the properties dialog.

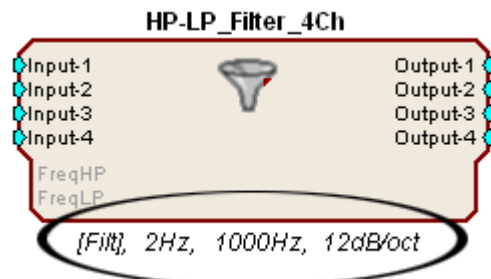

The HP-LP_Filter_4Ch macro should now display the tag access name *Filt* under the macro settings summary.



Tag Names are used in OpenController when assigning targets. A target points to the location of the data being read or the location to which a value will be written. Together with parameter tag components found in RpvdsEx, they provide a means of interacting with specific inputs and outputs.

In our case we have chosen to use the Tag Name *Filt*. This combined with the Access Tags option defined earlier in the macro setup makes two parameters available in our compiled circuit: FiltHP and FiltLP. These two parameter tags will be assigned later in our controller as targets of our real-time filter controls.

Adding the Signal for Demonstration Purposes

To add the demo signal:

1. Add a **Tone** generator component to the workspace.
 - a. Click the **Components** menu, click **Waveform_Generators**, and click **Tone**.

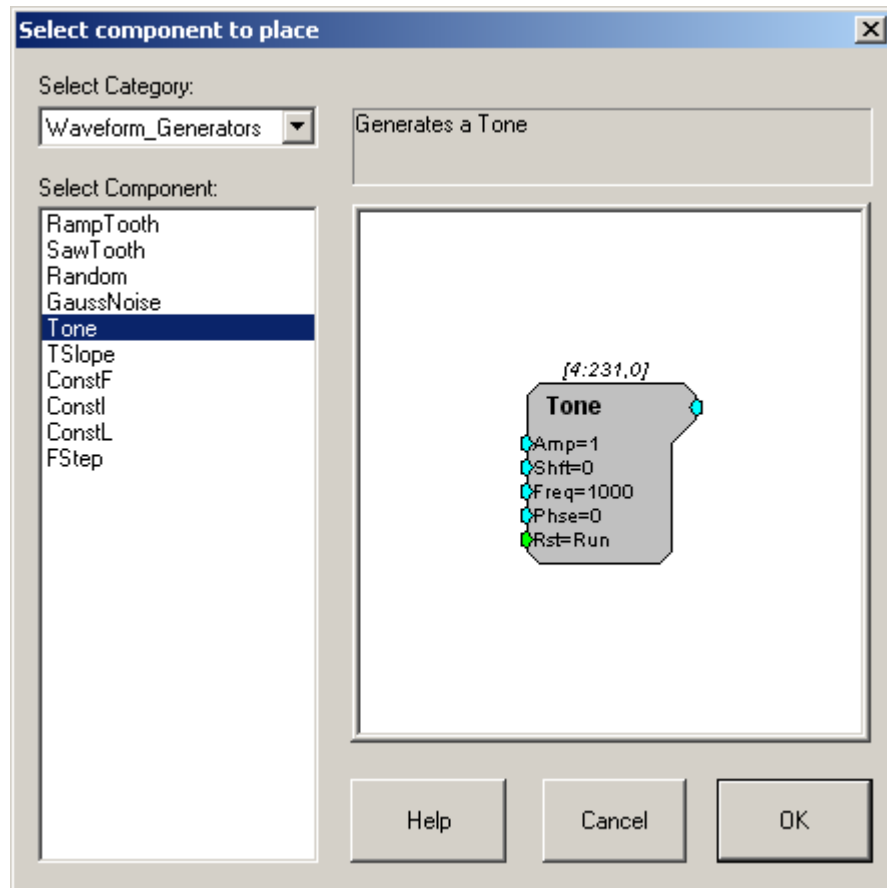

- b. Click **OK** and click the workspace to place the component.
- c. To set the frequency of the Tone generator to 2 Hz, double-click the component, click in the **Freq** box and type **2**.

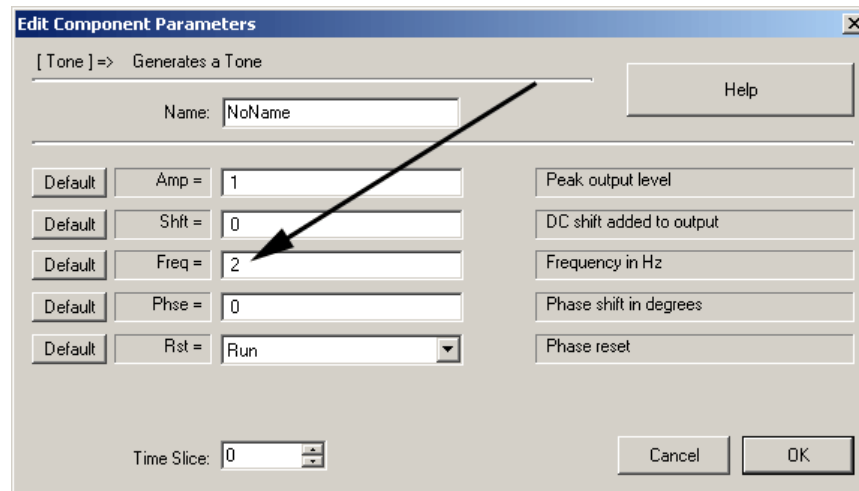

- d. Click **OK**.
2. Add a **GaussNoise** generator component to the workspace.
 - a. Click the **Components** menu, click **Waveform_Generators**, and click **GaussNoise**.
 - b. Click **OK** and click the workspace to place the component.
3. To link components, double-click the output of the first component and click the input of the second component.
4. Connect the outputs of both the **Tone** and **GaussNoise** generator components to the first and second HP-LP_Filter_4Ch component inputs.
5. Connect the HP-LP_Filter_4Ch component outputs 1 and 2 to the respective **Store-1** and **Store-2** inputs of the Stream_Store_1-4Ch component.

Your circuit should look like the one pictured below.

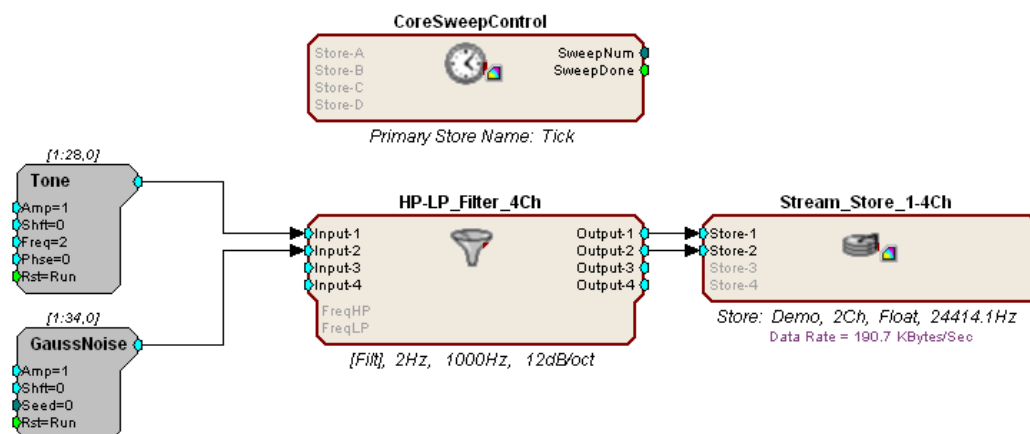

By default the graphical processing chain and the control circuit (control object) are combined into a single compiled circuit file format (.rcx file) that can be both edited in the graphical interface and loaded to hardware devices.

6. Click the **File** menu and click **Save As**

When the Project folder is created a subfolder named **RCOCircuits** is created to store compiled circuit files for the project. This folder should open by default.

7. Type *Tutorial* in the file name box and click **Save**.

Both the graphical processing chain and the control object are saved into one compiled circuit file: Tutorial.rcx in the default directory.

Notice that when the file is saved, the circuit is compiled. Any errors or warnings will appear at this time.

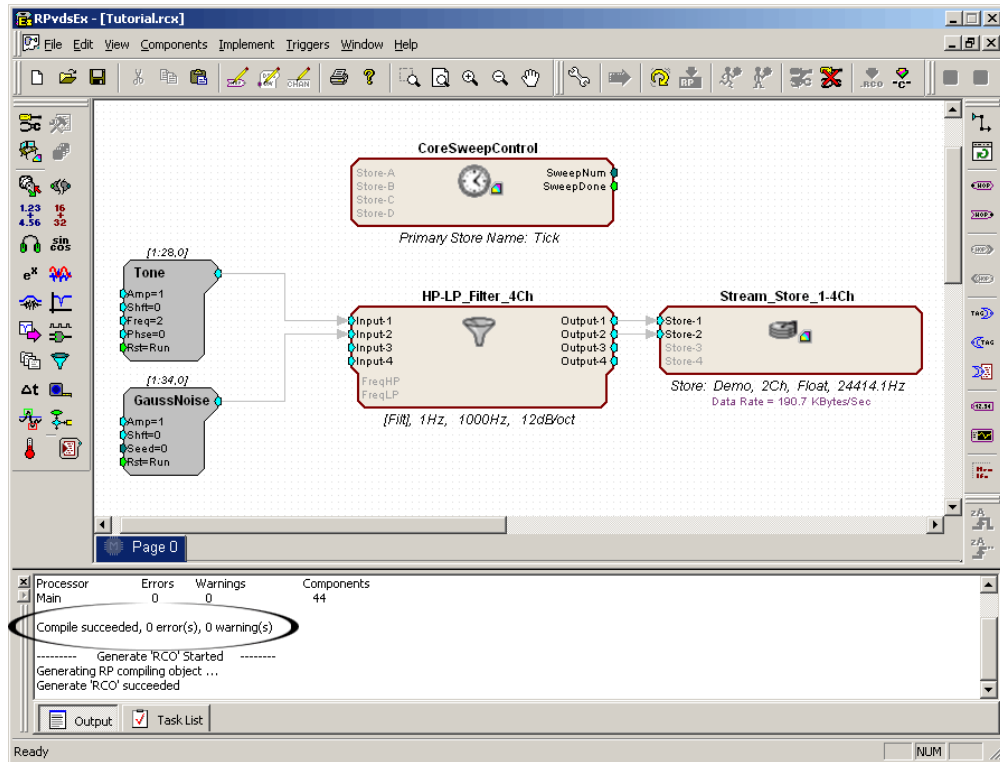

Configuring OpenWorkbench

During an experiment the compiled circuit file you created will be loaded to and run on one of the real-time processors. OpenWorkbench provides the interface used to assign the compiled circuit file to a device, configure high level settings, and start and stop the experiment.

To configure the experiment:

1. Select the **Workbench** icon in the OpenProject window.



2. In the OpenWorkbench window, the Device Navigator sub window displays all DSP modules connected to your PC. Since the project has not yet been configured, at this point, all devices should appear gray.

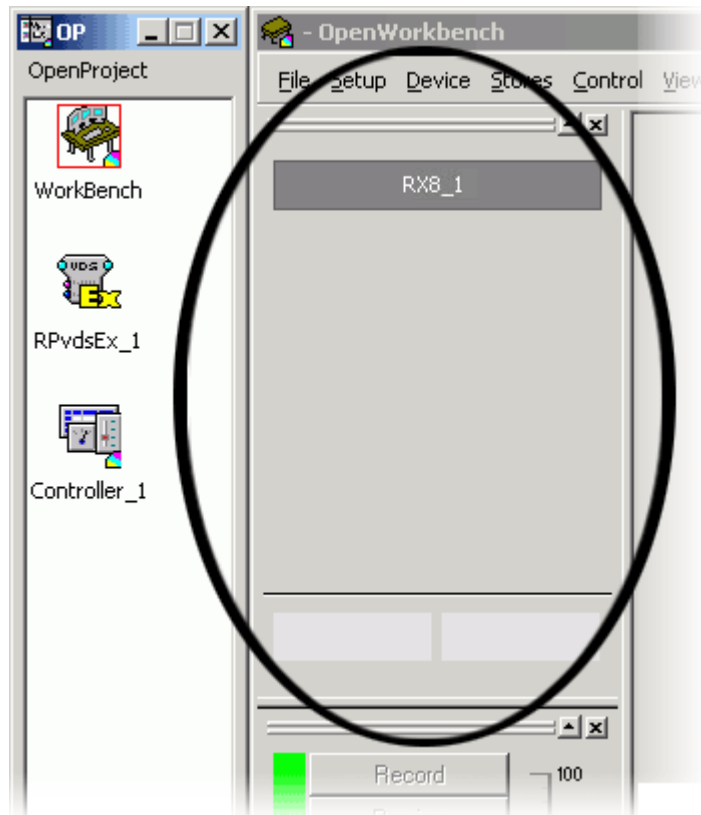

3. Select any one device on which to run this example and click its gray icon in the navigator. This will display the device configuration in the main part of the window.

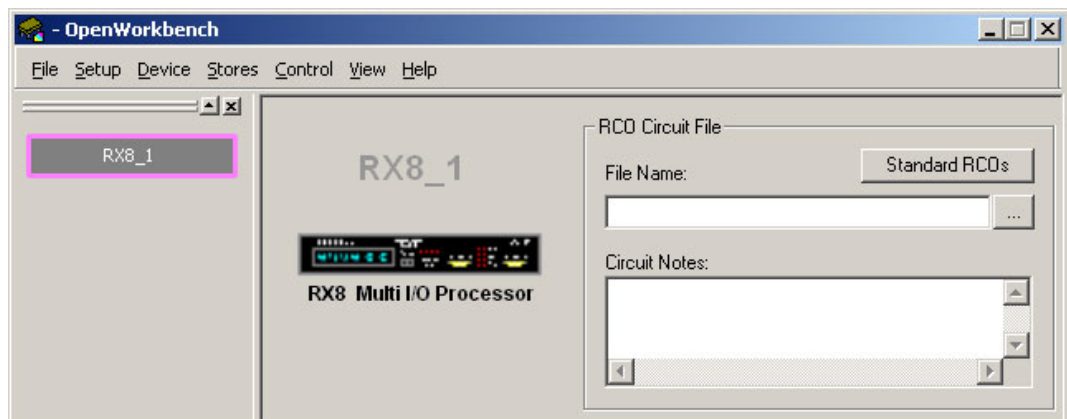

4. Click the **Browse** button  to the right of the **File Name** box to browse to and select the *Tutorial.rcx* file you created earlier.

You will be prompted to rename the Device. Click **OK** to accept the default name. You have now created a device configuration and assigned it to the device. The configuration is saved automatically as part of the WorkBench file.

At this point, OpenWorkbench automatically reads the compiled circuit file (.rcx), finds any data Stores included in the file, configures data storage parameters, and populates an editable Storage Specification table as shown below. In this example, the default “Tick” Store is generated by the CoreSweepControl macro and the “Demo” Store by the Stream_Store_1-4Ch

macro.

=== Storage Specification ===

	Mode	Store ID	Tag Name	Store Description	Sampling Rate (Hz)	Num Channel
1	Store	Tick	Tick/	Type-3,Scaler List(s) blocks of 1 floats		Single
2	Store	Demo	Demo	Type-5,Cont. Waveform blocks of 2048 floats	24414.1 (25K)	2
3						
4						
5						

In the Storage Specification table, data storage information is organized in rows. In the table pictured above, row 2 indicates that the compiled circuit file selected will store continuous waveform data acquired from two channels at a 25 kHz sampling rate. The tag name, Demo, was generated when you named the Store in the Stream_Store_1-4Ch macro. The Store ID is automatically generated based on that tag name.

The Store ID is associated with the corresponding data in the tank and is used by other clients, such as OpenScope or OpenController, when selecting or viewing data. You can change the Store ID by typing a new four character code in the Store ID cell, but in this tutorial we will use the default Store IDs.

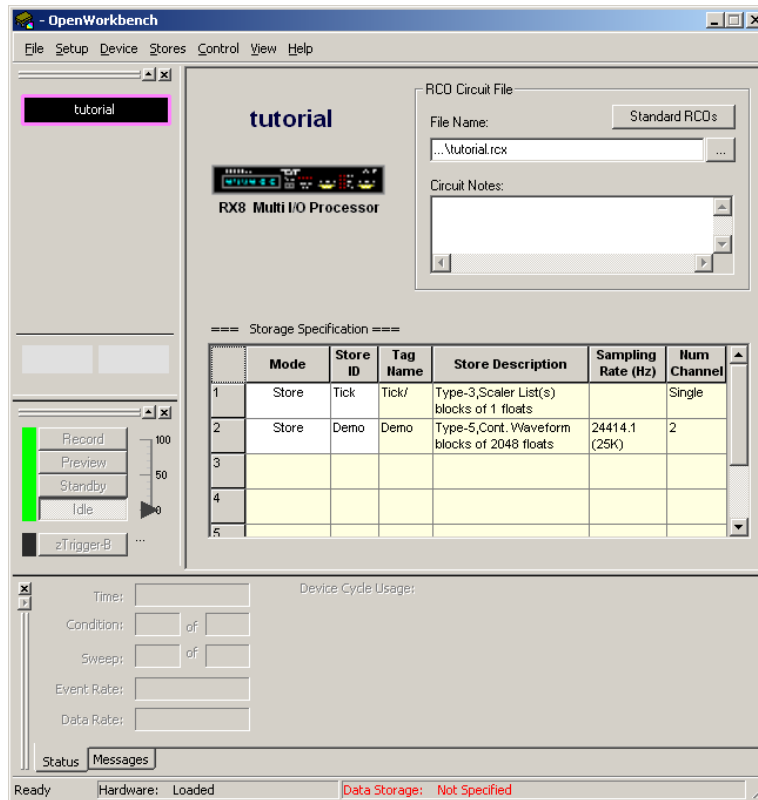

Note that at this point, the Workbench controls (Record, Preview, etc.) are grayed out and inactive. The reason for this is that a DataTank has not yet been set up in which to store any acquired data.

- Click the **File** menu and click **DataTank**.

In the Data Storage dialog box, select the  **NewTank** icon and specify a path for data storage and name the data tank *TutTank*, then click **OK**.

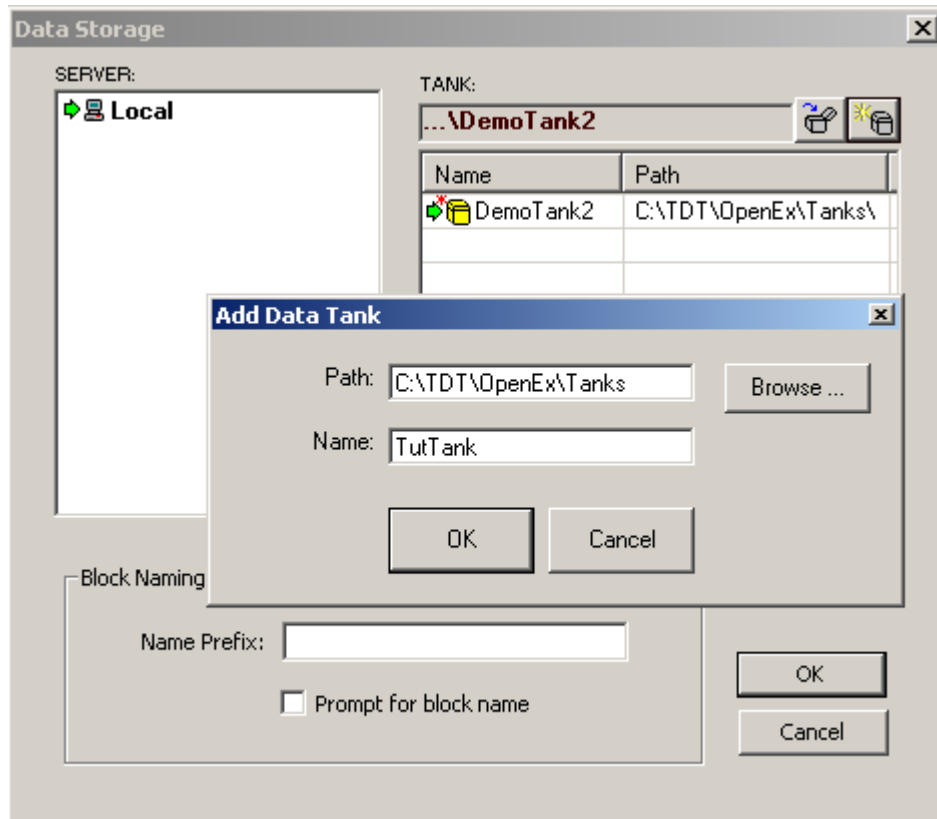

- Click **OK**.

Setup is complete and the Workbench controls are enabled.

Running the OpenEx Project

OpenWorkbench is the hardware server for the OpenEx suite. Because OpenWorkbench is the only application that communicates directly with the processors, it controls when an experiment begins and when data is collected and stored. These conditions are determined by OpenWorkbench's system modes, so it is a good idea to become familiar with them before you begin an experiment.

There are four modes:

- **Record** is used when you're ready to begin storing data to the data tank.
- **Preview** is used to test the system or when you want to modify parameters before you begin collecting data. This mode allows you to view data but the data is not stored permanently to the experiment's defined data tank.
- **Standby** should be used whenever the experiment must be paused. In this mode devices are loaded and running but signals are not being acquired and saved to disk.

- **Idle** should only be used when the experiment is completed. In this mode devices are not loaded and are not running. Idle mode clears all values from the hardware.

To run the project:

1. Click the **Record** button.

At this point, the automated plotting function in OpenWorkbench will generate a real-time plot displaying each stored data element.

2. Click the  **Autoscale** icon at the top of the plot to scale the display.

Your project should now appear similar to the illustration below, with the timing and sweep number of Onset epoch Tick shown across the top of the plot, and the two streaming channels *Demo[channel 1]* and *Demo[channel 2]* displaying their sine and Gaussian noise input waveforms.

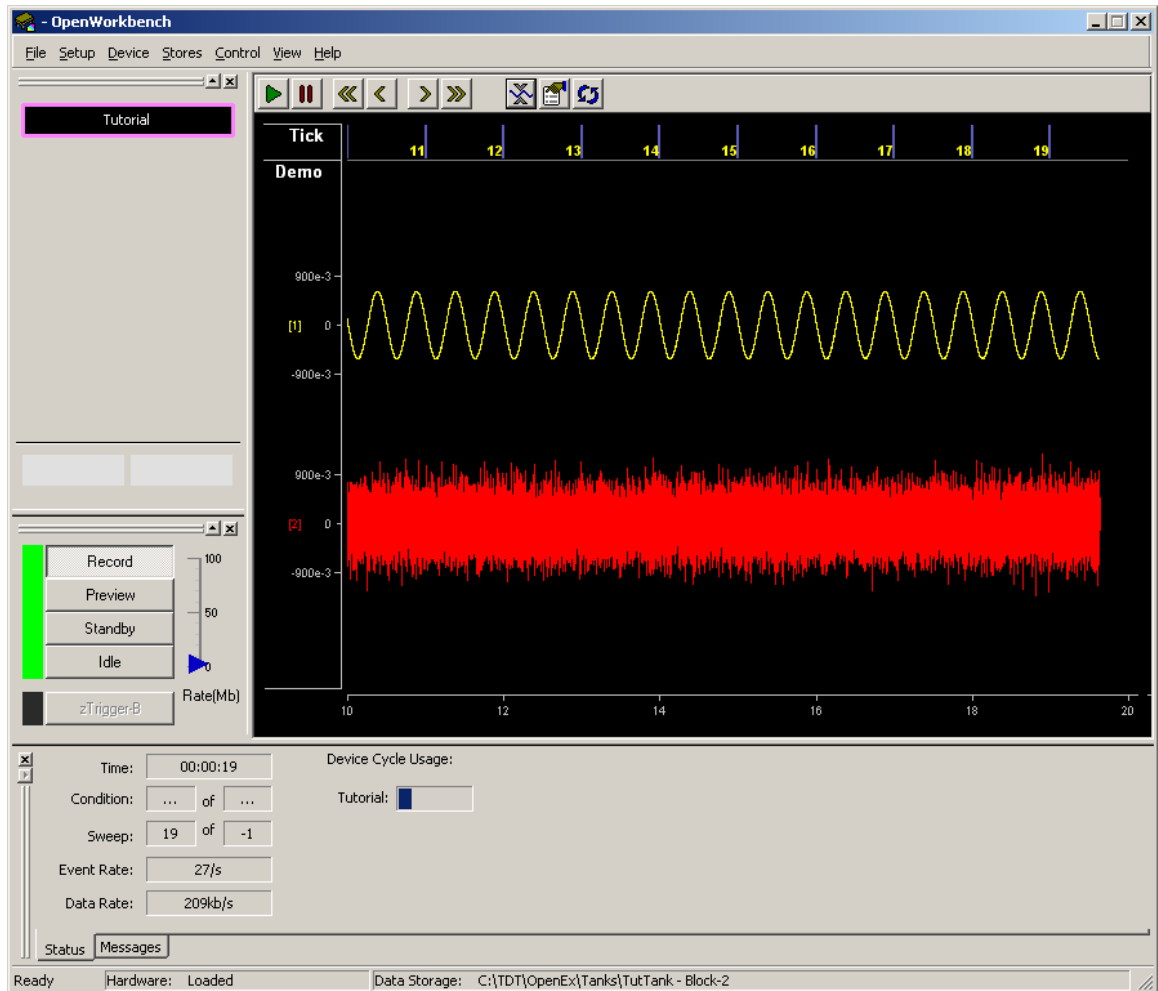

Adding the Real-Time Control

OpenController is a visual interface for designing and implementing custom control sets for OpenWorkbench experiments. OpenWorkbench generates a map of all the data in Stores and accessible parameters (or parameter tags, often contained in macros and transparent to the user) of the devices in memory.

As a client of OpenWorkbench, OpenController accesses this map to modify parameter variables and to read data for visualization.

Since this map is updated in real-time (several times a second) the data displayed in OpenController is also displayed in real-time. When OpenController modifies a parameter it is modified in this map and then updated on the device. OpenController acquires data from this map to access the variable information for data visualization. This results in real-time control for device parameters.

In this tutorial, you will adjust filter settings in real-time.

To switch to OpenController:

- Click Controller_1 in the OpenProject window.

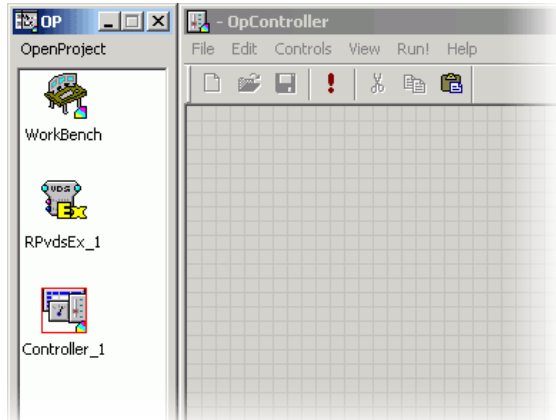

The OpenController window is displayed in Design mode. In Design mode you can add, configure, and modify controls.

The compiled circuit file used in this tutorial includes digital biquad filters for highpass and lowpass filtering. You can add two slide switches to control the corner frequency of these filters. Slide switches provide convenient real-time switching between several values.

To create the highpass filter setting slider:

1. Click the **Controls** menu, point to **Switches**, and click **Slide Switch**.
2. Click the grid to position the control.



3. Double-click the control to display the properties dialog box.
4. Click the **Browse** button  in the **Primary Target** box, to display the Select Target dialog box.
5. In the Target Select dialog box, click the expand icon (+) next to **Devices**, click the expand icon (+) next to **Tutorial**, click the expand icon (+) next to **Scalars**, and click **FiltHP**.

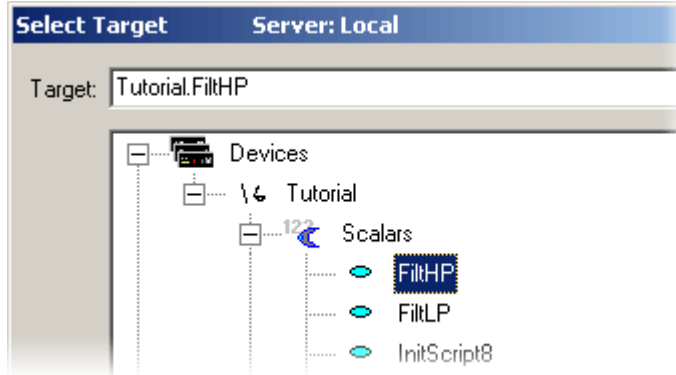

6. Click **OK** to return to the properties dialog and enter or select the following settings:

Caption Text:	Amp HP
Auto Caption	Clear the check box
Initialize Value	2
Initialize Mode	Init On Load
Position Labels	2, 3, 4, 5, 10, 30
Position Values	2, 3, 4, 5, 10, 30

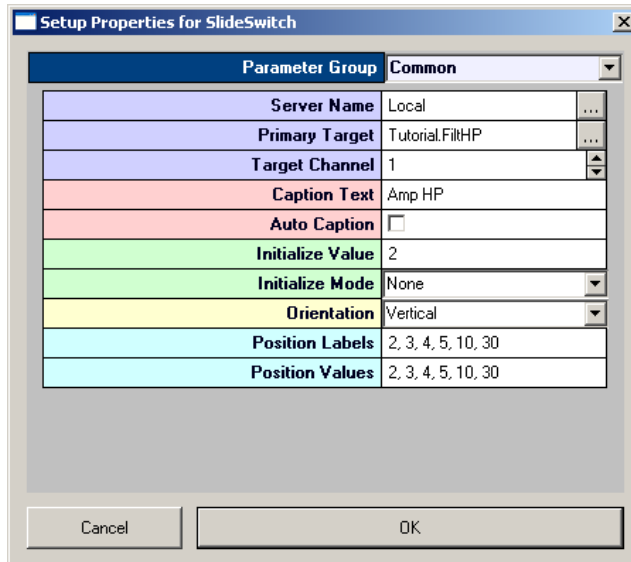

7. Click **OK**.

The slider switch is created. The slider can now be used to change highpass filter settings in real-time during an experiment.

Next, you'll create a slide switch for the lowpass filter setting.

To create the lowpass filter setting slider:

1. Click the Controls menu, point to Switches, and click Slide Switch.
2. Click the grid to position the control.
3. Double-click the control to display the properties dialog box.
4. Click the Browse button  in the Primary Target box, to display the Select Target dialog box.
5. In the Target Select dialog box, click the expand icon (+) next to **Devices**, click the expand icon (+) next to **Tutorial**, click the expand icon (+) next to **Scalars**, and click **FiltLP**.
6. Click **OK** to return to the properties dialog and enter or select the following settings:

Caption Text:	Amp LP
Auto Caption	Clear the check box
Initialize Value	2
Initialize Mode	Init on Load
Position Labels	2, 5, 10, 30, 100, 1000
Position Values	2, 5, 10, 30, 100, 1000

7. Click **OK**.

The slider switch is created. The slider can now be used to change lowpass filter settings in real-time during an experiment.

To create a scrolling plot:

1. Click the **Controls** menu, point to **Plots/Graphs**, and click **Scrolling Plot**.
2. Click the grid to position the control.

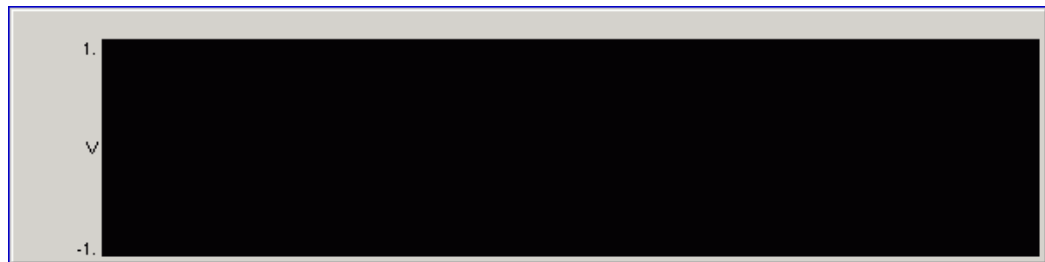

3. Double-click the control to display the properties dialog box.
4. Click the **Browse** button  in the **Data Target** box, to display the Select Target dialog box.
5. In the Target Select dialog box, click the expand icon (+) next to **Stores**, click **Demo** then click **OK**.
6. Change the **Poll Period** to **10** in the properties dialog box.
7. Check the **Multi View Enabled** checkbox.
8. Change the value of **Num Views** to **2**.

- Click **OK**.

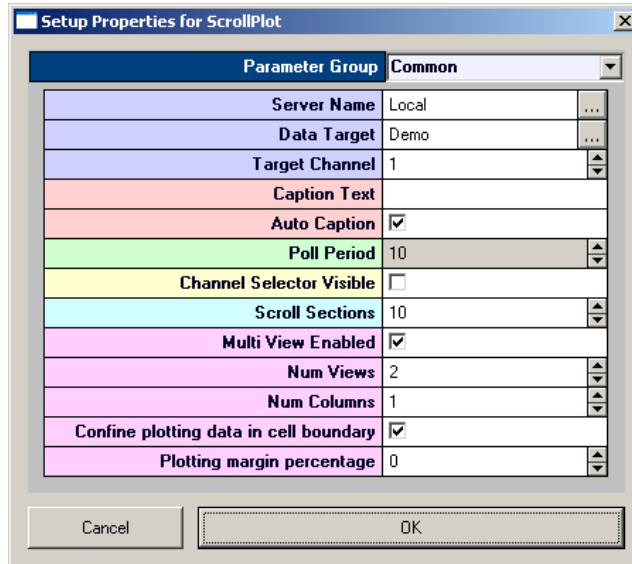

Visualize the Acquired Data

So far in this tutorial you have setup and compiled your device circuit, configured OpenWorkbench, and added real-time control in OpenController. It is now time to run the project and visualize the acquired data while adjusting the filter settings through OpenController.

To adjust the filter settings in real-time:

- Click **Controller_1** in the OpenProject window while OpenWorkbench is in either **Preview** or **Run** mode.
- Adjust the filter settings of each slider control to adjust the corner frequencies of the filter. Observe how each signal changes as the individual filter corner frequencies are altered.
- The Scrolling Plot allows data to be viewed while in OpenController and functions similarly to the plots in OpenWorkbench. Hold the **Shift** key and drag the mouse up or down to adjust the scale of the plot.

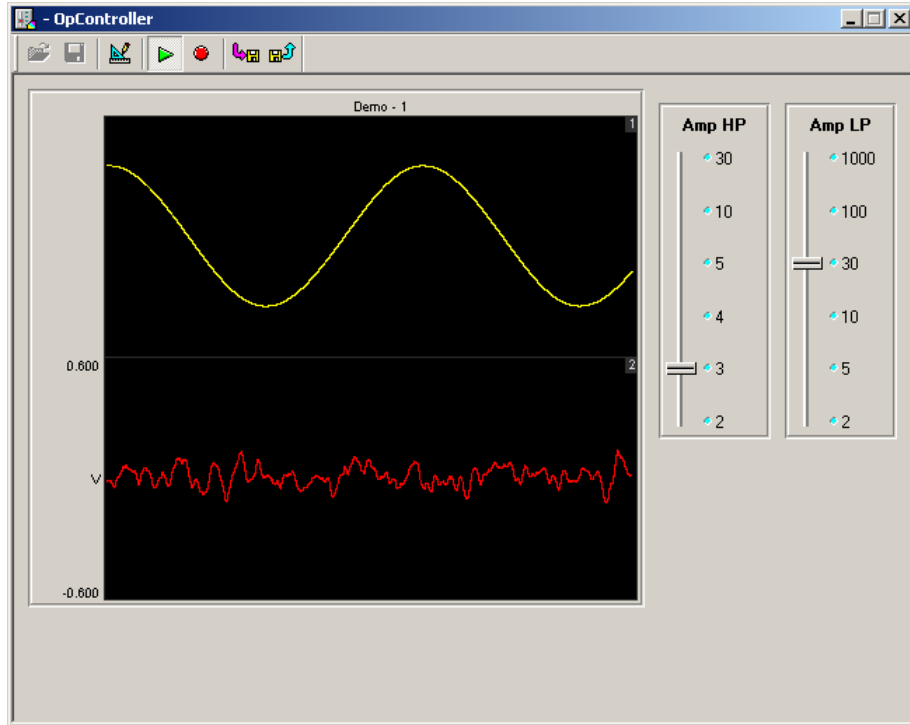

What's Next?

In this tutorial you created a project from the ground up using RpvdsEx macros. The next tutorial implements a useful feature in OpenEx called store pooling.

Tutorial 2: Store Pooling

In the *Store Pooling* tutorial, you'll learn to distribute data storage across DSPs on a multi-processor device. Splitting processing tasks across multiple DSPs lowers cycle usage for each DSP and allows the device to run efficiently, even when processing high channel counts or complex tasks. Filtering, signal input, and signal output can easily be distributed between DSPs simply re-routing the signals to different DSPs. Distributing data storage, however, requires splitting chunks of channels from a multi-channel data stream for processing on separate DSPs. Store Pooling simplifies this process and ensures that all the channels are stored as a single Data Store in the Data Tank.

In this tutorial you will:

1. Create an OpenEx project.
2. Design a processing chain to utilize store pooling and generate a compiled circuit file (*.rcx format)
3. Build the OpenWorkbench experiment.
4. Visualize and store data using OpenEx.

The project in this tutorial will acquire and store 32 channels of simulated data and display the acquired data streams in real-time. Storage will be divided across two separate DSP processors.



Keep an eye out for key OpenEx concepts. These concepts are extremely important when using OpenEx.

The Device

This tutorial requires the use of a high performance device such as an RXn or RZn processor.

The OpenEx Applications

In this tutorial you will be building the project from the ground-up. To design the processing chain that will implement store pooling you will use RPvdsEx. To design the experiment and to handle communication between the OpenEx environment and the hardware you'll need OpenWorkbench.

Creating the Project



1. Double-click the **OpenProject** icon on your desktop and create a new project.
2. Double-click the **Workbench** icon to add OpenWorkbench to the project.
3. Double-click the **RPvdsEx** icon to add one instance of RPvdsEx to the project.

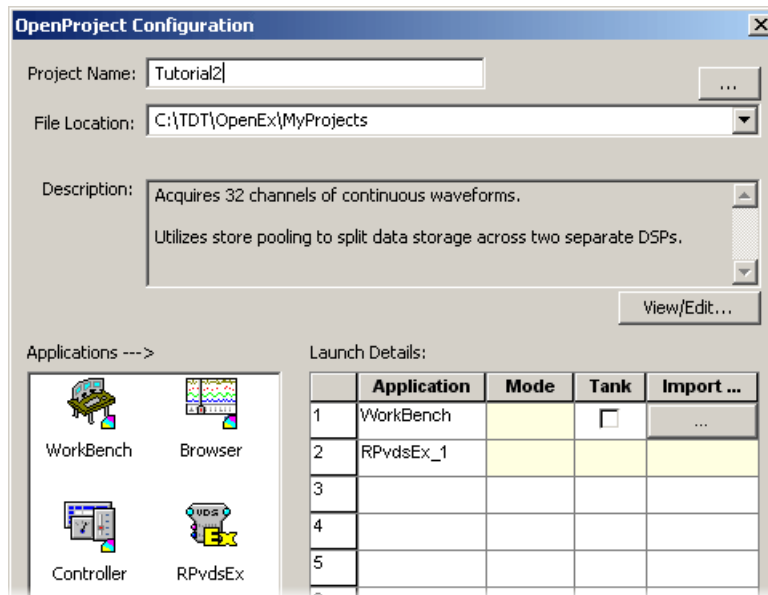

4. Click **OK**.

Designing a Processing Chain to Implement Store Pooling

1. Click the **RPvdsEx_1** icon in the OpenProject window.
2. In the RPvdsEx window, click the **File** menu and click **New**.
3. Click the  **Device Setup** button and select your high performance processor from the **Type** drop-down list.
4. Click **OK**.

Adding Required Timing and Synchronization

All timing and synchronization will be handled by the CoreSweepControl macro.

To add a CoreSweepControl macro:

1. In RPvdsEx, click the  **Insert Macro** icon on the RPvdsEx Components toolbar.
2. In the dialog box, select the **CoreSweepControl** macro from the **Macros | Timing** folder.
3. Click **Insert**. After the dialog box closes, click the workspace to place the component.

You can double-click the macro icon to view parameter menus and full documentation for the macro. No changes to the default settings of the CoreSweepControl macro are necessary for this tutorial.

Adding Signal Acquisition

To implement store pooling in RPsVsEx, two or more data storage macro are added and assigned to separate processors. Each macro is then “Fed” a subset of channels for processing from the multi-channel data stream.



All macros to be pooled must be configured with the same setup properties (such as the store name, number of channels, and window width) and one store macro must be identified as the primary Store.

This macro determines the total number of channels and contains the construct header for the data Store. Any subsequent macros are considered members of the pool and are ordered sequentially.

In this tutorial we will be using two storage macros to implement store pooling. Since the total number of channels needed is 32, each member of the pool will acquire 16 channels. Since we are working primarily with streaming data, a streaming storage component such as the Stream_Store_MC macro should be used.

Configuring the Primary Store

To add and configure the primary store:

1. Click the  **Insert Macro** icon, select the **Stream_Store_MC** macro (from the Macros | Data Saving | Streaming folder), click **Insert** then click the workspace to add the macro.
2. Double-click the macro to access the macro documentation and setup menus.

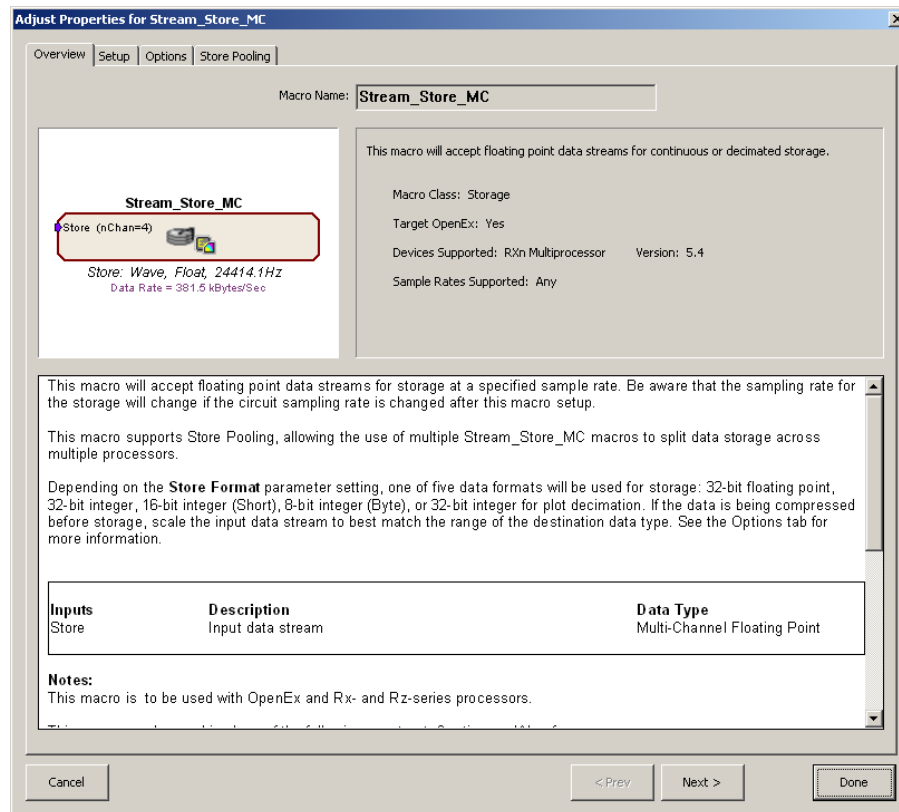

3. Click the **Setup** tab or click **Next**.
4. To set the macro to acquire 16 channels of data, set the **nChannels** value to **16**.

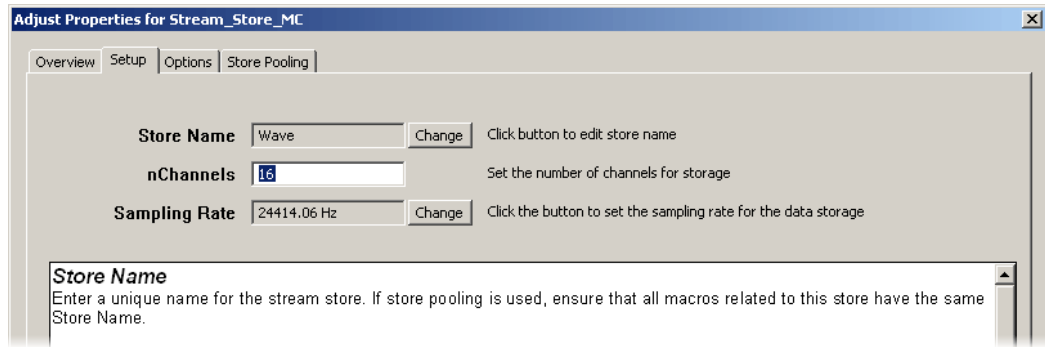

5. Click the **Store Pooling** tab or click **Next** twice.
6. Since this will be the primary store in the pool, select **Primary** from the **Pooling Position** drop-down box.
We will be configuring two stores in our pool so we must designate the total number of members.
7. Select **2** from the **Members In Pool** drop-down box.

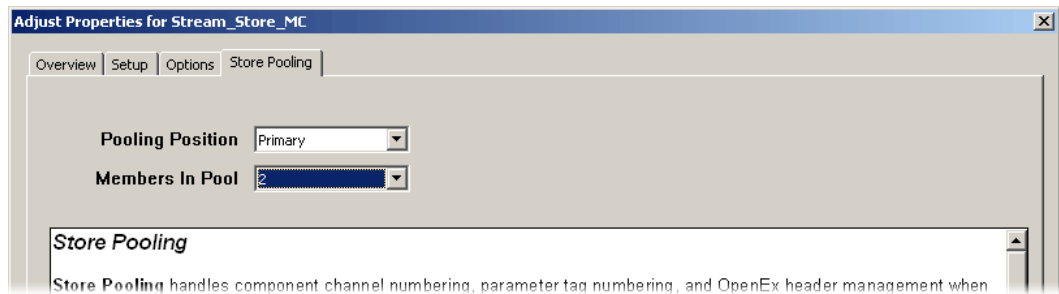

8. Finally, click **Done** at the bottom of the properties dialog.

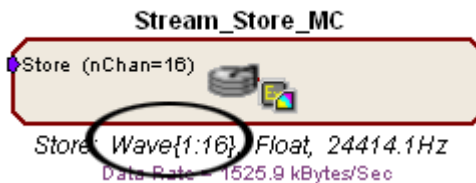

The Stream_Store_MC macro should now display the first 16 channels of the store in the macro property summary display.

Configuring the Second Store Macro

Once the primary store has been configured, a second store macro can be added by simply copying the primary store and adjusting the pooling position in the macro setup properties. This method ensures that all other necessary properties (such as the store name, number of channels, and window width) remain the same as the primary store.

To add and configure the second store macro:

1. Select the **Stream_Store_MC** macro that you just added to the workspace.
2. Select **Copy** from the **Edit** menu.
3. Click the workspace and select **Paste** from the **Edit** menu.
4. Double click the newly pasted **Stream_Store_MC** macro to access the macro documentation and setup menus.

- Click the **Store Pooling** tab or click **Next** twice.
- Since this will be the 2nd store in the pool, select **2nd** from the **Pooling Position** drop-down box.
- Select **2** from the **Members In Pool** drop-down box.
- Finally, click **Done** at the bottom of the properties dialog.

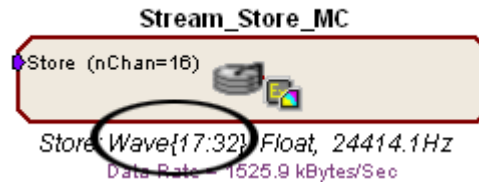

The Stream_Store_MC macro should now display the next 16 channels of the store in the macro property summary display.

Splitting up Processing Tasks

We have now configured the pooled store containing 2 members. To take advantage of the multi-processor architecture of the device, we must assign one of the members to another DSP processor. This will be accomplished through the use of the DspAssign component.

Note: Splitting processing tasks across DSPs can be done in two ways; pages and the DspAssign component. This tutorial features a small number of components and macros so the DspAssign component is sufficient for this task. Larger circuits may benefit from using pages. See the *RPvdsEx user manual for more information on how to use pages.*

To assign the second macro to another DSP:

- Add a **DspAssign** component to the workspace.
- Click the **Components** menu, click **Multi_Processor**, and click **DspAssign**.

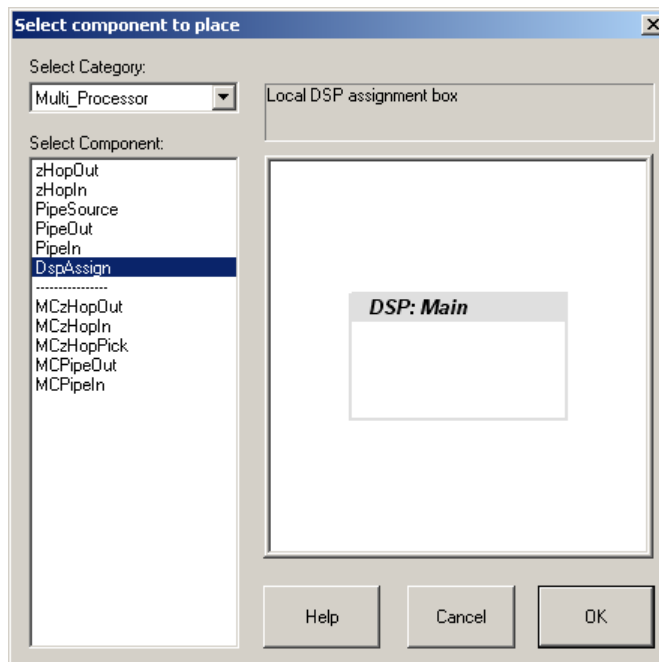

- Click **OK** and click the workspace to place the component.
- Resize the **DspAssign** component using standard windows drag techniques so that the secondary Stream_Store_MC macro is inside the DspAssign window.

5. Double-click the **DspAssign** component, select **Aux-1 / RZ_DSP-2** from the **DSP** drop-down box.
6. Click **OK**.

Your circuit should look similar to the one pictured below.

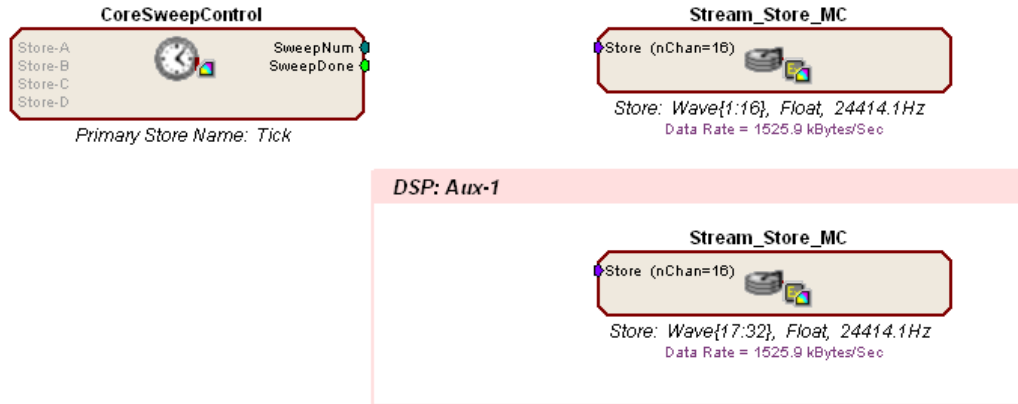

Adding the Signal for Demonstration Purposes

This tutorial will utilize a test signal for demonstration purposes. Real-world circuit applications will acquire signals from a preamplifier or other device output. The pooled stores themselves would be configured in the same manner.

To add the demo signal:

1. Click the  **Insert Macro** icon, select the **Test_Spike_MC** macro (from the Macros|SignalGenerators folder), click **Insert** then click the workspace to add the macro.
2. Double-click the macro to access the macro documentation and setup menus.
3. Click the **Setup** tab or click **Next**.
4. Enter **32** in the **Number of Channels** text box.
5. Click **Done** at the bottom of the properties dialog.

The output of the Test_Spike_MC macro will now be a 32 channel signal. We must now connect the necessary components in order to connect the demo signal to the storage macros.

We will use a MCzHopOut component to make the demo signal available to all DSPs. Two MCzHopIn components will allow the demo signal to be split into 16 channel partitions and distributed to the two pooled stores on separate DSPs.



There is a one cycle delay when transferring signals using the MCzHopOut and MCzHopIn components.

It is important that all stores are synchronized to these delays and so we will use a MCzHopIn for both stores.

To connect the demo signal to the pooled store:

1. Add a **MCzHopOut** component to the workspace.
2. Click the **Components** menu, click **Multi_Processor**, and click **MCzHopOut**.
3. Click **OK** and click the workspace to place the component.
4. To set the name for the MCzHopOut component, double-click the component, click the **Name** text box, and type **Demo**.
5. Enter **32** in the **nChan** text box to set the number of channels to 32.
6. Connect the output of the **Test_Spike_MC** macro to the **MCzHopOut** input.

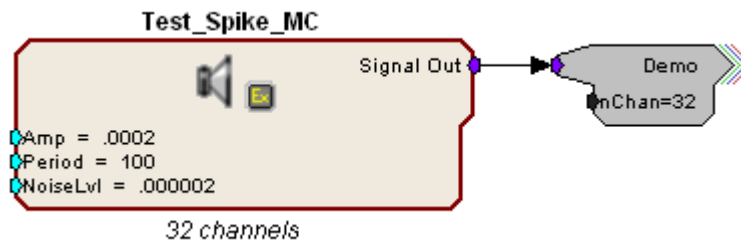

7. Add two **MCzHopIn** components to the workspace.
8. Click the **Components** menu, click **Multi_Processor**, and click **MCzHopIn**.
9. Click **OK** and click the workspace to place the component.
10. To set the name for the **MCzHopIn** components, double-click the component, click the **Name** text box, and type **Demo** for both components.
11. Enter **16** in the **nChan** text box to set the number of channels to 16 for both MCzHopIn components.
12. Enter **17** in the **ChanSel** text box to set the first channel to 17 on the second MCzHopIn component.
Setting the ChanSel parameter to 17 starts the index for the MCzHopIn to 17. Since it is configured to use 16 channels this corresponds to channels 17 – 32 or the same range of the secondary store macro.
13. Connect both **MCzHopIn** components' outputs to the Store inputs for each **Stream_Store_MC** macro. The MCzHopIn with a ChanSel value of 17 should be connected to the second store macro. You may have to resize the DspAssign window to fit the MCzHopIn component.
14. To double check this, look at the macro parameter summary, the second store macro will have *Wave{17:32}* labeled for the store information.

Your circuit should look similar to the one pictured below.

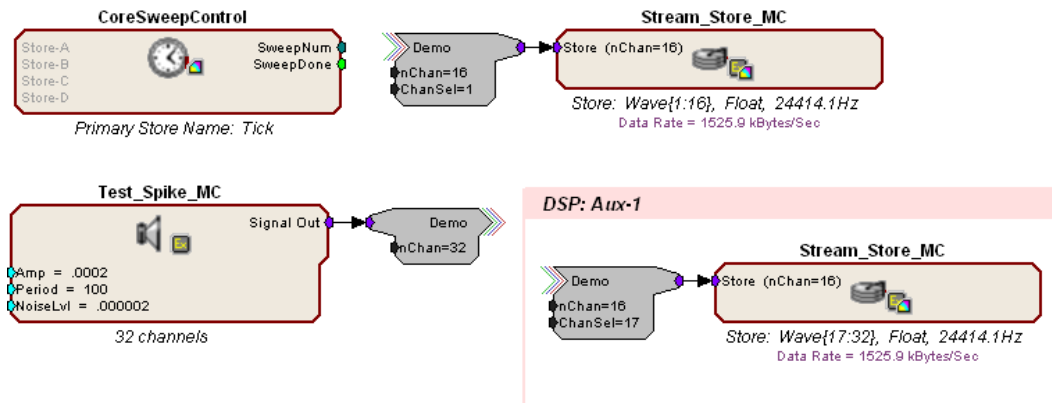

15. Click the **File** menu and click **Save As**

When the Project folder is created a subfolder named **RCOCircuits** is created to store compiled circuit files for the project. This folder should open by default.

16. Type a filename in the file name box and click **Save**.

Both the graphical processing chain and the control object are saved into one compiled circuit file in the default directory.

Configuring OpenWorkbench

In this section we will configure the experiment by loading the compiled circuit file to a device. Since we have implemented store pooling, the storage specification table should populate only two stores, the Tick store provided by the CoreSweepControl macro and our Wave store provided by the pooled Stream_Store_MC macros.

To configure the experiment:

1. Select the **Workbench** icon in the OpenProject window.
2. Select any one device on which to run this example and click its gray icon in the navigator. This will display the device configuration in the main part of the window.

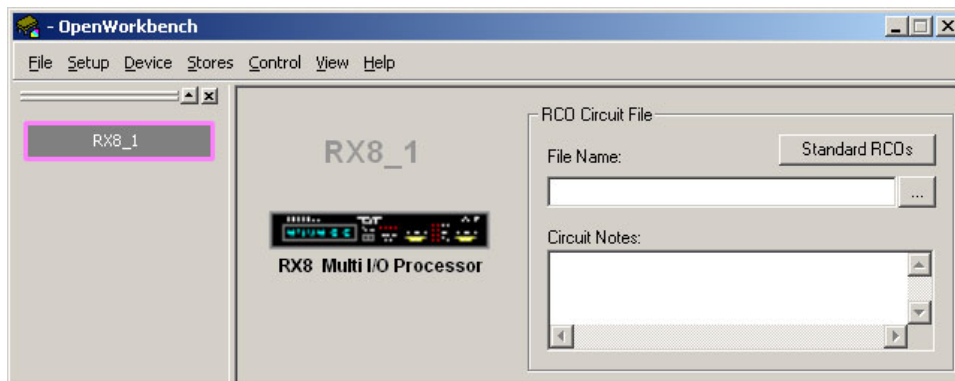

- Click the **Browse** button  to the right of the **File Name** box to browse to and select the RpvdsEx file you created earlier.

You will be prompted to rename the Device. Click **OK** to accept the default name.

The configuration is saved automatically as part of the WorkBench file.

Notice that in addition to the *Tick* store added by the CoreSweepControl macro, our pooled store is listed as a single 32 channel store *Wave*.

=== Storage Specification ===

	Mode	Store ID	Tag Name	Store Description	Sampling Rate (Hz)	Num Channel
1	Store	Wave	Wave	Type-5,Cont. Waveform blocks of 2048 floats	24414.1 (25K)	32
2	Store	Tick	Tick/	Type-3,Scaler List(s) blocks of 1 floats		Single
3						
4						
5						

- Click the **File** menu and click **DataTank**.
- Configure an existing DataTank or create a new DataTank.
Setup is complete and the Workbench controls are enabled.

Running the OpenEx Project

OpenWorkbench displays the pooled stores as one store entity despite the fact that the data is being processed on two separate DSPs. This keeps the plot simple and easy to visualize.

To run the project:

- Click the **Record** button.
- Click the  **Autoscale** icon at the top of the plot to scale the display.
- Your project should now appear similar to the illustration below, with the timing and sweep number of Onset epoch Tick shown across the top of the plot, and the streaming channels *Demo[channels 1 - 32]* displaying the demo signal.

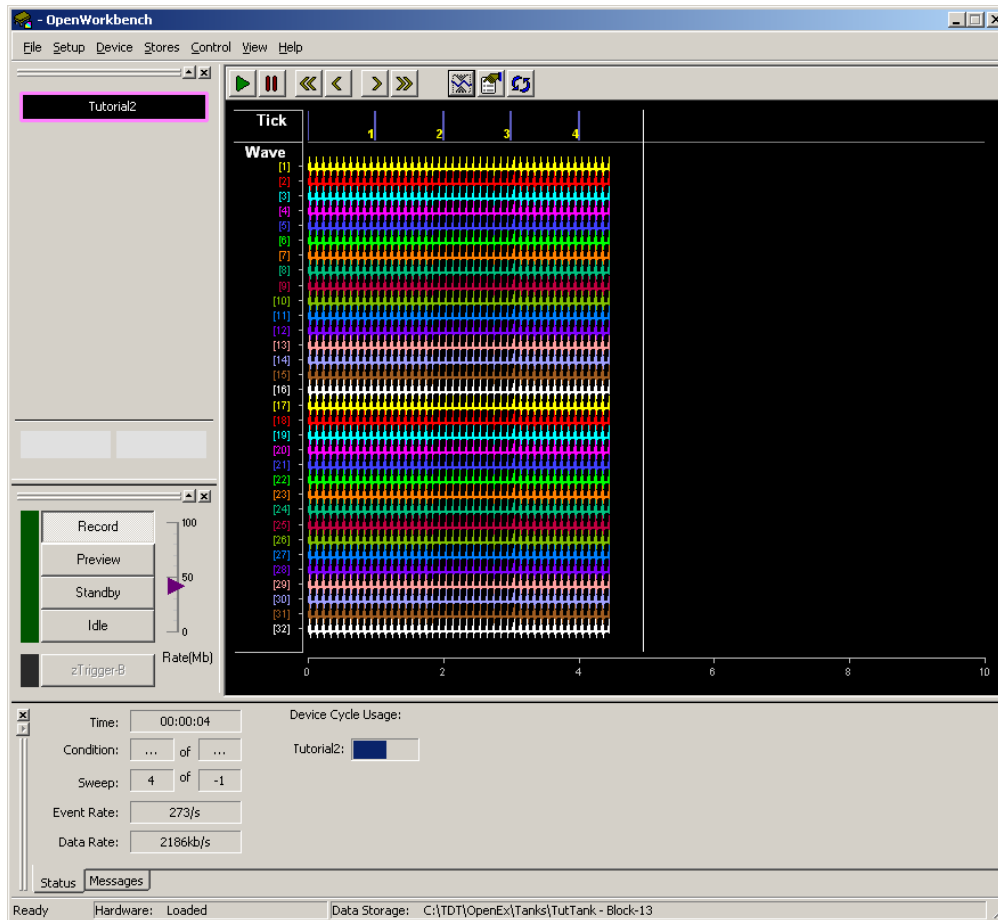

What's Next?

In this tutorial you created a project from the ground up using RPvdsEx macros and configured individual pooled stores across separate DSP processors. Refer to the OpenEx reference sections for more information on each application in the OpenEx Suite.

Additional Standard Project and Example Files

When OpenEx Suite is installed a number of project files are installed for your use. These projects can provide a means of getting basic experiments up and running quickly and can be modified to meet the needs of your paradigm. The RCO Files used by each project are targeted for specific typical hardware configurations but can often be modified for use with other hardware combinations. See the RPvdsEx Manual for circuit design techniques.

EEG Projects

Project File: TDT\OpenEx\StdProjects\EEG\SP3001\SP3001.wsp

Standard Hardware: RA16BA Medusa Base Station and RA4PA or RA16PA Medusa PreAmp

Overview: Acquires four channels of EEG data and filters for alpha, beta, and theta waves. Stores raw data continuously and stores RMS of the alpha, beta, and theta waves ~12 times per second.

Project File: TDT\OpenEx\StdProjects\EEG\SP3002\SP3002.wsp

Standard Hardware: RA16BA Medusa Base Station and RA4PA or RA16PA Medusa PreAmp

Overview: Acquires four channels of EEG data and filters for alpha and beta waves. Stores raw data continuously and stores RMS of the alpha and beta waves ~12 times per second.

Project File: TDT\OpenEx\StdProjects\EEG\SP3003\SP3003.wsp

Standard Hardware: RA16BA Medusa Base Station and RA4PA or RA16PA Medusa PreAmp

Overview: Acquires one channel of EEG data and filters for alpha, beta, delta, and theta waves. Stores raw data continuously and the levels of filtered waveforms are calculated to deliver a stimulus when the energy factor reaches a certain value.

Project File: TDT\OpenEx\StdProjects\EEG\SPM0504\SPM0504.wsp

Standard Hardware: RX5 Pentusa Base Station and RA16PA Medusa PreAmp

Overview: Acquires 16 channels of EEG data and filters for alpha, beta, delta, and theta waves. Stores RMS for Alpha, Beta and Theta waves.

Project File: TDT\OpenEx\StdProjects\EEG\SPM0505\SPM0505.wsp

Standard Hardware: RX5-5 5-DSP Pentusa Base Station and four RA16PA Medusa PreAmps

Overview: Acquires 64 channels of EEG data at 6103 Hz and stores the data in short (16-bit) format.

Project File: TDT\OpenEx\StdProjects\EEG\SPM0506\SPM0506.wsp

Standard Hardware: RZ5 BioAmp Processor and RA16PA Medusa PreAmp

Overview: Acquires 16 channels of EEG data and filters for alpha, beta, delta, and theta waves. Stores RMS for Alpha, Beta and Theta waves.

Project File: TDT\OpenEx\StdProjects\EEG\SPM0803\SPM0803.wsp

Standard Hardware: RZ2 BioAmp processor and PZ3 Amplifier

Overview: Acquires 32 channels of EEG data and filters for alpha, beta, delta, and theta waves. Stores the RMS of the alpha, beta, and theta waves.

Extracellular Projects

Many of the extracellular projects are provided in two versions, one using macros (indicated by inclusion of "SPM" in the file name) and one that does not. Typically the circuit files used in the macro based projects are easier to work with and make minor modifications. The non-macro circuit projects demonstrate circuit design techniques that may be used in those cases where macros are not available or greater flexibility is required.

Project File: TDT\OpenEx\StdProjects\Extracellular\SP0001\SP0001.wsp or
StdProjects\Extracellular\SPM0001\SPM0001.wsp

Standard Hardware: RA16BA Medusa Base Station and RA4PA or RA16PA Medusa PreAmp

Overview: Acquires a single channel of spike data. Includes an automated window discriminator and a spike sorting control. Also includes a fake spike generator that can be used to test of the system and become comfortable with the thresholding and spike sorting controls for data collection.

Project File: TDT\OpenEx\StdProjects\Extracellular\SP0100\SP0100.wsp or
StdProjects\Extracellular\SPM0100\SPM0100.wsp

Standard Hardware: RA16BA Medusa Base Station and RA4PA or RA16PA Medusa PreAmp

Overview: Acquires, sorts, and stores candidate spikes across multiple recording sites (up to four channels). Provides real-time control of spike discrimination and sorting and includes automatic threshold detection and sorting.

Project File: TDT\OpenEx\StdProjects\Extracellular\SP0501\SP0501.wsp or
StdProjects\Extracellular\SPM0501\SPM0501.wsp

Standard Hardware: RX5-5 5-DSP Pentusa Base Station and two RA16PA Medusa PreAmp

Overview: Sorts and acquires 32 channels of neural spike data. LFPs are also stored for all channels.

Project File: TDT\OpenEx\StdProjects\Extracellular\SP0502\SP0502.wsp or
StdProjects\Extracellular\SPM0502\SPM0502.wsp

Standard Hardware: RX5-5 5-DSP Pentusa Base Station and four RA16PA Medusa PreAmp

Overview: Sorts and acquires 64 channels of neural spike data.

Project File: TDT\OpenEx\StdProjects\Extracellular\SPM0503\SPM0503.wsp

Standard Hardware: RX5 Pentusa Base Station and RA16PA Medusa PreAmp

Overview: Acquires 16 channels of data and stores the values as 32-bit floating-point numbers.

Project File: TDT\OpenEx\StdProjects\Extracellular\SPM0507\SPM0507.wsp

Standard Hardware: RZ5 BioAmp processor and two RA16PA Medusa PreAmps.

Overview: Sorts and acquires 32 channels of neural spike data. LFPs are also stored for all 32 channels.

Project File: TDT\OpenEx\StdProjects\Extracellular\SPM0802\SPM0802.wsp

Standard Hardware: RZ2 BioAmp processor and a PZ2 preamplifier.

Overview: Sorts and acquires 64 channels of neural spike data. LFPs are also extracted and stored for all 64 channels. The active channel can be monitored via the Port E- #9 front panel BNC.

Tuning Curve Projects

Project File: TDT\OpenEx\Examples\ManualTuner\ManualTuner.wsp

Hardware: RP2.1 Real-Time Processor for stimulation and RA16BA Medusa Base Station with RA16PA or RA4PA Medusa PreAmp for acquisition.

Overview: Generates an auditory tuning curve (or frequency threshold curve) mapping the threshold boundary of a neuron or fiber. Allows users to approximate the neuron's center frequency (or frequency of maximum sensitivity). It acquires sorted spike data as well as measures of level and frequency.

Project File: TDT\OpenEx\Examples\AutoTuner\AutoTuner.wsp

Hardware: RX6 MultiFunction Processor for stimulation and RX5 Pentusa Base Station with RA16PA or RA4PA Medusa PreAmp for acquisition.

Overview: Uses the characteristic frequency (found by running the Manual Tuning Curve example) to generate stimuli with a random sequence of frequencies and intensities. This automated stimulus presentation is then used to determine the tuning curve of a cell. This example demonstrates how scripted elements can be incorporated into the OpenEx environment to provide extended functionality.

Evoked Response Project

Project File: TDT\OpenEx\Examples\EvokedResponse\EvokedResponse.wsp

Hardware: RP2.1 Real-Time Processor for stimulation and RA16BA Medusa Base Station with RA16PA or RA4PA Medusa PreAmp for acquisition.

Overview: Presents stimulus tone pips at 50 ms while running a 12 kHz sample rate. The acquisition period is 83.9 ms (1024 point average). Data is acquired and averaged for four channels of data.

OpenDeveloper Examples

Several OpenDeveloper example files are installed with OpenEx Suite in the *Examples\TDevAcc_Example* and *Examples\TTankX_Example* folders. See the OpenDeveloper Reference Manual for more information.

OpenProject Reference

In the OpenProject Reference you will find:

A reference guide to the OpenProject Workspace and the basics of creating projects.

About OpenProject

OpenProject acts as the essential environment integration tool for OpenEx, greatly simplifying the system's ease of use. Managing a single directory structure of experiment files for all OpenEx programs is the main focus for OpenProject.

Why the need for OpenProject?

OpenEx software is built on a very powerful Client/Server architecture, allowing a number of smaller applications to come together in one powerful environment, configured to suit the needs of each project. For example, if you don't need complex real-time views of your data as its being recorded, you probably won't use OpenScope at run time. However, if histograms and raster plots are important in your work then you'll need to include this application in your project. The multi-application approach also offers a more distributed system, whereby, multiple computers can be used to process and visualize your data in real-time. This client/server advantage comes at the expense of a higher level of system complexity. In addition to having more applications to keep track of and navigate on screen, there are more associated support and configuration files. OpenProject provides the solution for both of these problems.

The OpenProject Interface

The OpenProject interface allows users to open and close an entire OpenEx configuration with a single mouse click. Window handling and desktop layout are also controlled easily through OpenProject. A program navigation bar provides easy paging through each of the applications in your project. This includes multiple instances of applications like OpenController with each given a logical name like, 'Sort Control' and 'Amplifier Control'. Programs are automatically sized and stacked together with the default 'load on top' page defined by the user. Applications can also be 'floated' so they can be positioned anywhere on the screen for simultaneous viewing.

OpenProject File Management

Each application in your OpenEx project has one or more associated files. For example, OpenWorkbench uses a single .xpm file to store configuration information about timing, devices, and so forth and each OpenWorkbench configuration references one or more device circuit (.rco or .rcx) files. OpenProject organizes all project files in a single directory tree named at its root for the project. Optionally, local copies of circuit files are kept in a special RCOCircuits directory and applications that use and edit these files will, by default, navigate to this dedicated directory. This makes keeping track of your associated RPvdsEx circuits a more reasonable task and allows you to customize the circuits running in one configuration without corrupting the circuit's operation in another configuration. When applications are run under OpenProject, their associated file load/save functions are disabled and handled automatically by OpenProject. Entire projects can be moved, copied, and renamed easily with the project management tools available in OpenProject.

About the OpenProject Window

The OpenProject Window is a tall narrow window that appears to the left of OpenEx applications when they are opened or run as part of a project. The window displays icons for each application included in a project and allows the user to quickly navigate between applications. The window display is divided into two areas. The upper area displays icons for applications that are docked

(attached) to the OpenProject window. The lower area displays icons for applications that are floating (not attached).

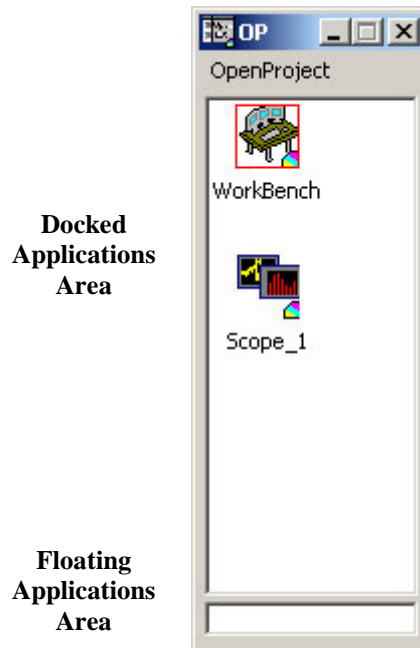

Using the OpenProject window:

Click an icon to make the corresponding application the active (top) window.

Drag the divider to change the relative sizes of the docked and floating areas.

To attach or float an application, drag its icon across the divider.

To close an application without closing OpenProject, right-click its icon and click Close on the shortcut menu.

To delete an application, right-click its icon and click Remove on the shortcut menu.

Creating a Project

Work on any OpenEx experiment begins with creating a project.

To create a project:

1. Launch **OpenProject**.
2. In the OpenProject window, click the **OpenProject** menu and click **New Project**.
3. In the OpenProject Configuration window:
 - a. In the **Project Name** box, type a project name.
 - b. In the **File** box, type a complete path for, or browse to, the location where you want the project folder to be created. All project files will be stored in the new folder.
 - c. Click the **View/Edit** button below the **Description** box.
 - d. In the **View/Edit** Description dialog box, click the **Edit** check box and type a description in the text edit area then click **OK** to return to the OpenProject Configuration window.
4. Double-click an application icon to add the application to the next row in the Launch Details list. **Repeat for each application that will be associated with the project.**
5. In the **Mode** cell for each added row that contains an OpenController or OpenScope application, select the launch mode. See *About the OpenProject Configuration Window* below for a description of modes.

6. To ensure that all applications reference the same data tank, click the check box in the **Tank** cell for each application line where it appears.
7. To use an existing file for a given application, click in the corresponding **Import** cell. Browse to the desired file and double-click the file name.
8. Click **OK** to close the OpenProject Configuration window.

When a project is created a new folder with the user specified name is created. The project file (.wsp) and a file for each added application is created in this new folder. DataTanks, RCOCircuits, and UserFiles folders are also created in the project folder. Tank files may also be created and added to the DataTanks folder (depending on project preferences).

Note: If you import an OpenWorkbench file, an RPvdsEx (.rpx or .rcx) file for any compiled circuit files specified in the OpenWorkbench application might also be added to the RCOCircuits folder. You can change the *Keep local copy of RPvds circuits* setting in the OpenProject Preference dialog box.

About the OpenProject Configuration Window

The OpenProject Configuration window opens whenever a new project is created. It allows the user to enter basic project information such as the name and location of the project and to add all of the applications, or files that will be used in the project. It can also be used to add application files to existing projects or to change the launch modes of previously added applications. After a project has been created the OpenProject Configuration window can be accessed through the Configure Project command on the OpenProject menu.

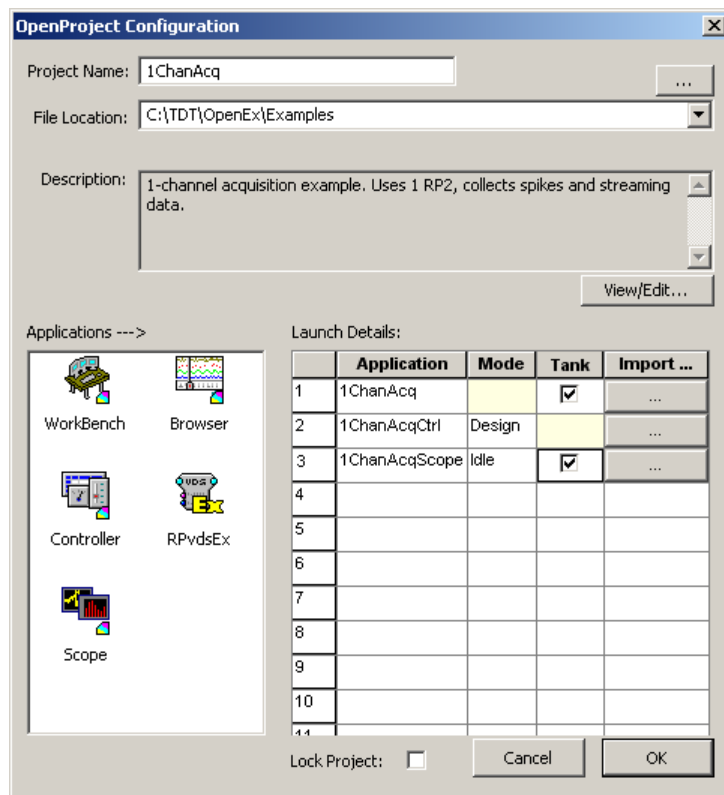

Project Name

The name of the folder that will be created to store all files for the project.

File Location

The location where the project folder will be created. Type a path in the File Location, click the browse button to browse for a path, or click the arrow to select a recent location from a drop-down list.

Description

An optional text description associated with the project. The View/Edit button can be used to add/edit the description or to view lengthy descriptions.

Applications

Displays an icon for each application type that can be added to a project.

Double-click an icon, or drag an icon to the Launch Details area to add the application. Multiple instances of client applications, such as OpenScope and OpenController may be added. Only one OpenWorkbench file can be added per project. Adding an application will also add a corresponding file for that application.

Launch Details

Each row in this table can represent an application that has been added to the project. The order in which applications are displayed in the Launch Details list indicates the order in which the application icons will be arranged in the OpenProject window.

Application Column

An application can be renamed by clicking in the application cell and editing the text. This name is both the file name for the individual application file and the name displayed along with the icon in the OpenProject window.

Mode Column

After an OpenController or OpenScope application has been added to a row in the Launch Details list a drop-down menu is available in the Mode cell. The Mode set here determines the mode in which the application will be launched when the project is opened.

OpenController...

Run - launches in Run mode with controls running.

Design - launches in Design mode to allow the user to add, remove, or modify controls before running.

Stop - launches in Run mode with controls stopped.

OpenScope...

Idle - allows users to select a data block or add, remove, or modify controls before running.

Animate - plots are animated with last selected data block settings.

Track - plots are animated with the most recent block of data from a currently recording experiment.

Tank Column

After an OpenWorkbench or OpenScope application has been added to a row in the Launch Details list a check box is available in the Tank cell. Clicking the check box ensures that the tank used by that application is synchronized with the project. If the tank is changed for the project it will be changed for all synchronized applications.

Import Column

The cells in this column allow users to import an existing file for use with an added application. When a file is imported, the imported file overwrites the default application file but retains the default applications file's filename.

Lock Project

This check box locks the project to prevent editing. The project may be run but not modified. Projects can be unlocked from the OpenProject menu.

Adding Applications to an Existing Project

You can add applications to an existing project by opening the OpenProject Configuration window and adding applications to the Launch list. You can also add an application directly from the OpenProject window using the Add Components command on the OpenProject menu.

Adding Docked Applications to a Project

The main area of the OpenProject window can be used to launch and navigate between applications that are attached to the OpenProject window.

To add a docked application:

1. Right-click the Docked Applications area of the OpenProject window.
2. Point to **Add Component**, and click the application to add.

Launching a Floating Application

The area of the OpenProject located below the adjustable pane divider can be used to launch and navigate between applications that are not attached to the OpenProject window.

To launch a floating application:

1. Right-click the Floating Applications area of the OpenProject window.
2. Point to **Launch in Float Mode**, and click the application to launch.

Changing Launch Settings

After a project has been created, the project description and launch settings can be modified by re-opening the OpenProject Configuration window.

To open the OpenProject Configuration window:

1. Right-click the Applications area of the OpenProject window.
 2. Click **Config Project**.
- Or
- Click **Config Project** on the OpenProject menu.

Stop Making Local Copies of RPvdsEx Files

By default, OpenProject stores a copy of all files associated with a project, including RPvdsEx circuit files in the project folder.

To stop making local copies of RPvdsEx circuit files:

1. Right-click the Applications area of the OpenProject window.
2. Click **Preferences**.
3. On the **Project RCO Files** tab of the OpenProject Preferences dialog box, clear the **Keep local copy of RPvds circuits** check box.

To make the current setting the default for all new projects:

- Select the **Save As Default** check box, in the OpenProject Preferences dialog box.

Working with Data Tanks in OpenProject

When working in OpenEx, all data is stored to an OpenEx data tank. Each tank may contain several blocks of data from different experimental protocols and different subjects. To provide data management, users may wish to have tanks automatically generated at regular intervals or based on events.

Managing New Tank Creation

In the OpenProject Preferences dialog box, users can choose when and how new data tanks are generated. Users can choose to be prompted to create a new tank at regular intervals or based on events. The prompt may also include an auto naming scheme.

To configure Data Tank Synchronization Options:

1. Right-click the Applications area of the OpenProject window.
2. Click **Preferences**.
3. On the **Data Tank Synchronization** tab of the OpenProject Preferences dialog box, select the desired configuration option from the **Prompt New Data Tank** area.
4. If auto naming is necessary, click the **Auto Name Tank** check box.

Note: The Tank box must be checked in the OpenProject Configuration window for at least one component for a tank to be automatically generated.

To make the current setting the default for all new projects:

- Select the **Save as Default** check box, in the OpenProject Preferences dialog box.

Importing Application Files

When users create a new project or add applications to an existing project the user can import an existing file for an application. When a file is imported a copy of the file is made which replaces the default application file in the project folder. The default application file filename does not change. When an OpenWorkbench file is imported, by default, a copy of the RPvdsEx circuit file is added to the project folder.

Important! Tank files are NOT copied or imported when an OpenWorkbench file is imported. They remain in their original location and should not be moved or deleted. Moving or deleting tank files may result in loss of data.

New Projects

If the user is creating a new project it is a good idea to import files in the OpenProject Configuration window.

To import files in the OpenProject Configuration window:

1. Add an application to the Launch list.
2. Click the **Import** cell for the desired application row.
3. In the Open dialog box, browse to the file to import.
4. Select the file to import and click **Open**.
5. Repeat this process for each file to import.

Existing Projects

If the user is adding an application to an existing project, a corresponding application file can be imported directly in the OpenProject window.

To import a file in the OpenProject window:

1. Add an instance of the desired application.
2. Right-click the new application icon.

Caution: Importing a file to an application instance other than a newly created application may result in lost configuration information.

3. Click **Import** on the shortcut menu.
4. Browse to the desired file and click **Open**.
5. Click **Yes** if prompted to discard current settings.
6. Repeat the process for each file to import.

Note: This process replaces an existing application file in a project. Keep in mind that importing a file into an existing application instance removes the file previously assigned to that application instance from the project.

Importing RPvdsEx Files

When an OpenWorkbench file is imported, standard RPvdsEx files used by the OpenWorkbench file will be imported automatically. A corresponding RPvdsEx file is also imported automatically when a compiled circuit file is assigned to the Project's OpenWorkbench file. To import an

RPvdsEx file that is not assigned to an OpenWorkbench file, users must open the desired file from within the RPvdsEx application and save it as part of the project.

Menus and Dialog Boxes

OpenProject Menu

The OpenProject menu is available from the menu bar or by right-clicking the permanent applications area. Some menu choices are only available when a project is open.

New Project	Opens the OpenProject Configuration window.
Load Project	Opens the Open Project File dialog box so that an existing OpenProject file can be opened.
Close Project	Closes the current project.
Save Project	Saves the current OpenProject file and all project application files.
Save As	Saves a copy of the current project with a new name in a user selected location.
Unlock Project	Unlocks a locked project. Only available when the project is locked.
Data Tank	Opens the OpenProject DataTank Setup Dialog box. This option is enabled only if Data Tank Synchronization is enabled from the OpenProject Configuration window.
Configure Project	Opens the OpenProject Configuration window so that project settings can be changed.
Add Component	Opens a Submenu that allows the user to add an instance of OpenWorkbench, OpenController, OpenScope, OpenBrowser, or RPvdsEx to the project.
Clean Project	Opens the Clean Project dialog box and allows users to remove unwanted files from the project.
Preference	Opens the OpenProject Preferences dialog box and allows the user to set whether RPvdsEx files will be saved with projects and to set tank synchronization preferences.
Recently Used Files	This section of the File menu lists recently used project files. Clicking a file name opens the file.
Exit	Closes OpenProject and all project applications.

Application Icon Shortcut Menus

Right-click any application icon in the OpenProject window to display a short cut menu.

Import	Opens a dialog box that allows users to browse to an existing file for import to the selected application.
Attach	Docks the selected application window to the OpenProject window.
Float	Floats the selected application window.
Close	Closes the selected application without closing the project.
Open	Opens a closed application.
Remove	Deletes the selected application from the project.

OpenProject DataTank Setup Dialog Box

When the data tanks for the project are synchronized (Tank check box selected for applications in the OpenProject Configuration window), this dialog box can be used to change the tank used throughout the project. To view available options, right-click to display the shortcut menu. This dialog box is opened from the Data Tank command on the OpenProject menu.

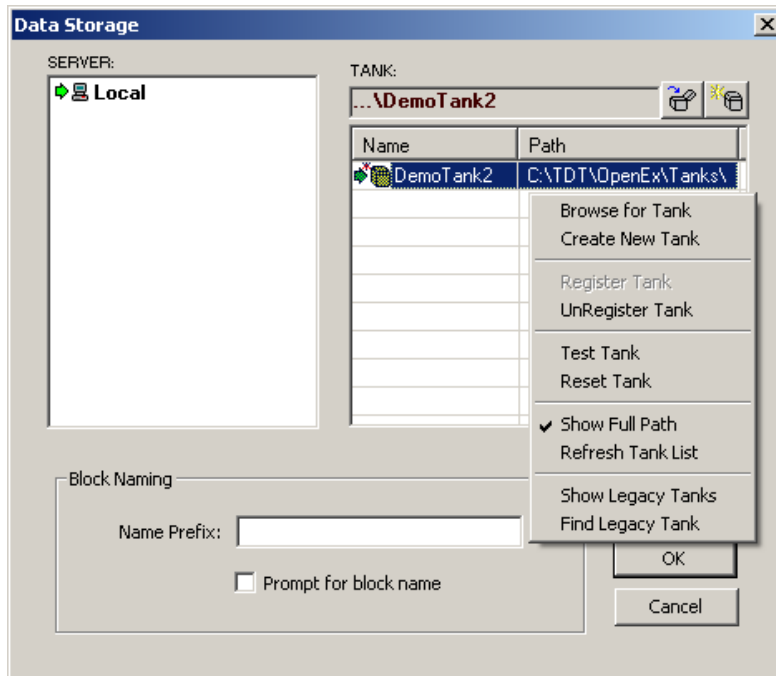

OpenProject File Dialog Box

The OpenProject File dialog box is a variation of the standard Windows Open dialog box. It includes a shortcut bar and a description area.

The description area displays the project description for a selected project file. The Shortcut bar can be used to quickly navigate to a frequently used folder or file.

To create a shortcut, drag a folder or file from the list to the shortcut bar. You will be given an opportunity to name the shortcut. This dialog box is opened from the Load Project command on the OpenProject menu.

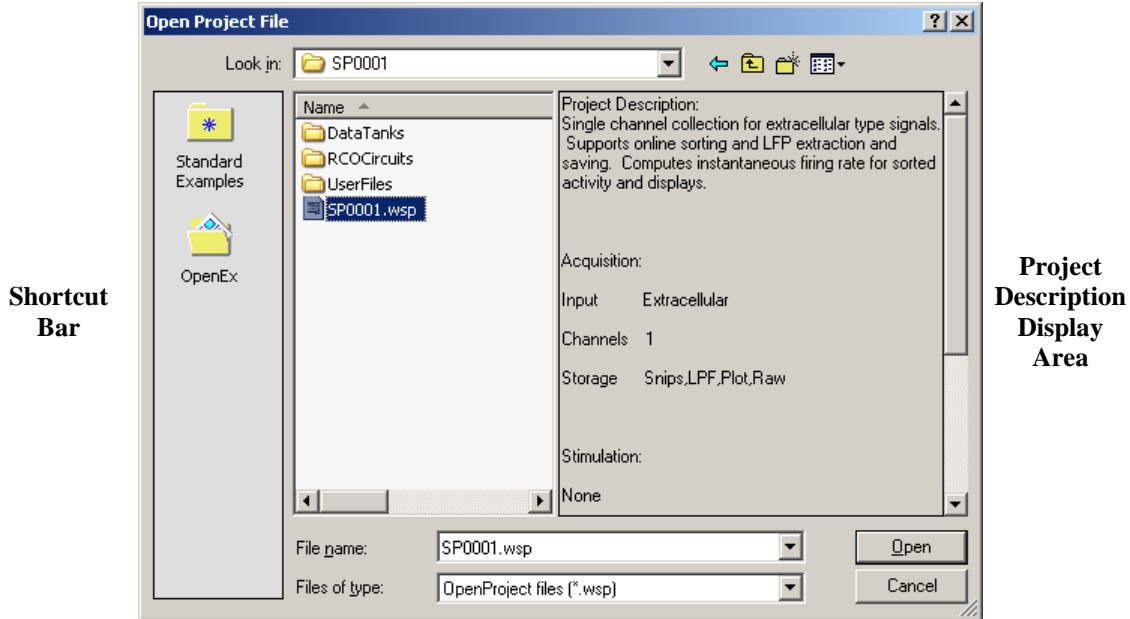

About the OpenProject Preferences Dialog Box

The OpenProject Preferences dialog box can be used to determine whether compiled circuit files are retained in the project folders and to determine when the user will be prompted to begin a new data tank. It is opened from the Preferences command on the OpenProject menu.

Project RCO Files Tab

Keep local copy of RPs vs circuit - This check box determines if copies of RPs vs Ex circuit files associated with an OpenWorkbench file are saved in the project's RCO Circuits folder. When this check box is cleared, new projects created in the current OpenProject session will not include local copies of these files. Clearing this check box will NOT remove files from a currently open project. This setting is not retained in future sessions of OpenProject unless *Save As Default* is selected.

Save As Default - When this check box is selected, the current *Keep local copy of RPs vs circuits* setting is saved as the default and will be retained when OpenProject is closed and reopened.

Data Tank Synchronization Tab

Prompt New Data Tank - The user can select from the available choices to determine how often they will be prompted to begin a new data tank for the project. When the Auto Name Tank check box is selected the prompt will include a suggested name that consists of the project name, an incremented number code, and a date. This helps to ensure that tanks will be kept at a manageable size and may be used to help keep experiment data organized, daily, by recording session, or by OpenProject session.

Save as Default should also be selected to retain the setting for the next OpenProject session.

Circuit Design Reference

In the Circuit Design reference you will find:

Information about RPvdsEx macros and basic circuit design for OpenEx.

~

Circuit Design Overview

Circuits can be modified or designed from within OpenProject by adding an instance of the RPvdsEx application. RPvdsEx is the latest version of TDT's RP Visual Design Studio. RPvdsEx allows the user to modify existing RPD, RPX, or RCX files and create compiled circuit files for use with OpenWorkbench.

Note: All files created or modified in RPvdsEx are saved in the RCX format and might not be compatible with earlier versions of RPvdsEx.

Before modifying a circuit file, be sure to work through the *Getting Started with OpenEx Tutorial* found on page 9 and review *Tips for Modifying Circuits* found on page 352.

OpenEx Circuit Design

TDT's System 3 hardware is user programmable through the RPvdsEx circuit design applications. Compiled circuit files (compiled circuits, either .rco or .rcx) developed in RPvdsEx can be used in OpenWorkbench to generate stimuli, acquire signals, and control other hardware devices.

OpenEx circuits have two to three main subcomponents defined as circuit constructs:

- Control constructs that determine how a circuit behaves under OpenEx.

At a minimum a control construct contains a clock and typically includes control over timing and triggering. More complex control constructs allow for control of stimulus generation, and data acquisition. The most reliable way to implement the necessary control elements is to include the CoreSweepControl macro in every circuit file designed for OpenEx. Additional sweep based controls are provided by the StandardTimeControl macro.

- Data constructs that define the type of data and the way the data is stored in the tank.

TDT has defined five data constructs. Each construct represents one of the three data types. The most common of these have been implemented via the Data Saving macro set.

- User defined constructs.

Users can add additional circuitry to customize data acquisition and stimulus presentation.

OpenWorkbench relies on a rigid naming structure and standard circuit constructs, or groupings of circuit components and parameter tags within the compiled circuit file to allow users to change parameter values from the PC and visualize data in real-time. These details are handled behind the scenes within the RPvdsEx macros. Macros simplify circuit design, allowing the user to 'drop in' pre-debugged circuit chunks guaranteed to provide smooth integration with OpenEx. If a macro is not available for a given task the user must use extra caution to design the circuit with all OpenEx conventions in mind.

More details about working directly with parameter tags and non-macro constructs are available in the Appendix A – Non Macro Circuit Construct Reference beginning on page 313.

A Brief Review of Terminology

Compiled circuit files are RP control objects, designed by users or TDT, for use with OpenEx and other applications. May be in .rco or .rcx format.

RPvdsEx files contain circuit diagrams designed in a visual drag-and-drop environment. May be in .rpd, .rpx, or .rcx format.

Circuits are made up of components. Each component does a set task, such as generate a waveform, store in memory, or send a signal to hardware outputs.

Circuit constructs are a group of components that perform a defined task in OpenEx. A circuit construct will have a minimum or required component structure and secondary or alternate component structures.

Macro/Construct Mapping Table

Each of the core group of Macros listed below provides the functionality of one or more of the “circuit constructs” typically used in OpenEx projects. Detailed information about inputs, outputs, and properties of each macro can be found within the macro’s tabbed properties dialog box.

Macro Name	Device Types	Function
CoreSweepControl	single and multi-processor devices	generation of the core timing & control signals used in every OpenEx circuit this macro must appear once and only once in each circuit that uses other macros and is used in OpenEx
StandardTimeControl	single and multi-processor devices	generation and storage of the basic timing/control signals needed to drive various stimulation or acquisition structures
HP-LP_Filter (1Ch, 4Ch)	single and multi-processor devices	filtering of floating point data streams through cascaded highpass (HP) and lowpass (LP) filters
HP-LP_Filter (MC)	multi-processor devices only	
Block_Store (1-8 Ch)	single and multi-processor devices	continuous or decimated block storage of floating point data streams
Block_Store (MC)	multi-processor devices only	
Stream_Store (1-8 Ch)	single and multi-processor devices	
Stream_Store (MC)	multi-processor devices only	

Epoc_Store	single and multi-processor devices	storage of scalar Epochs on transitions of control or signal inputs
Slow_Store (1-8 Ch)	single and multi-processor devices	triggered storage of floating point or integer data streams
Slow_Store (MC)	multi-processor devices only	
Spike_Store (1-8 Ch)	single and multi-processor devices	spike thresholding and sorting of floating point data streams using the FindSpike, SortSpike, SortSpike2, or SortSpike3 components, and storage of the snippets
Spike_Store (MC)	multi-processor devices only	

Control Constructs

About Control Constructs

OpenEx is designed for time critical data acquisition and stimulus presentation. To ensure precise triggering of all System 3 hardware devices, a global trigger is sent to each of the System 3 hardware device caddies (zBus). At the simplest level (continuous acquisition) this will start a clock that generates a time stamped output. Most timing and control can be handled using one of the following macros.

CoreSweepControl

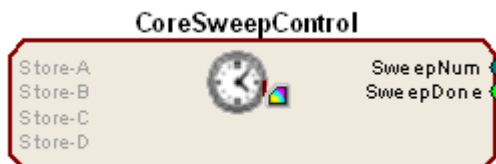

Primary Store Name: Tick

The CoreSweepControl macro should be used in every circuit file intended for use in OpenEx. It produces core timing and control signals required in all circuits designed for use with OpenEx. Its functions include:

- Starting and synchronizing timing generators on each real-time processor used in the OpenEx project
- Generating timing pulses for all sweep-based (e.g.) stimulation or acquisition protocols
- Storing the sweep number and timestamp
- Optionally creating up to four additional secondary Stores for saving epochs at the onset of each sweep. Sweep number and timestamp are saved using a Data List (Type-2) storage method.

The CoreSweepControl works with both single and multi-processor devices and automatically distributes timing signals used in other macros in a way that is transparent to the user. OpenWorkbench triggering, sweep duration and sweep count are implemented within this macro. Double-click the macro icon in RPvdsEx to view detailed help for the macro.

StandardTimeControl



The StandardTimeControl macro is used to time and record information for repetitive, sweep-based, (e.g.) stimulus or acquisition control periods. OpenWorkbench sweep settings used to set the onset delay and duration of a sweep are implemented in this macro. Three timing signals are generated relative to the onset of each sweep. These indicate the onset, offset and duration of a control period and are available as macro outputs named ^On, ^Off and Control. These would be used in turn to control acquisition or stimulation components in later stages of the processing chain.

Three optional Stores are included to record Epoch events (scalar values) at the onset or offset of the control period. These are normally used to store the stimulus or control parameters that are active at the start or end of the control period and should be used only for signals that are synchronous with it.

Regardless of whether the onset or onset_offset mode is assigned to the primary Store, Stores A and B are acquired at the sweep onset and require the primary Store for their timestamp.

Double-click the macro icon in RPvdsEx to view detailed help for the macro.

Data Storage

Data in OpenEx can be categorized into three basic data types: scalar values, discrete waveforms (often called snippets or segments), and continuous waveforms (often called streamed data). Data storage macros have been developed to simplify the structure of circuit design and storage configuration. Each data storage macro contains a data construct which defines what type of data will be handled by the macro. All storage configurations take place behind the scenes.

Choosing a Data Construct

The following table provides a direct comparison of the three data types used in OpenEx, the constructs that implement them, and the macros needed to handle the data.

Data Type	Scalar Data	Discrete Data	Continuous Data
Macro to use	Epoc_Store Slow_Store_MC	Block_Store_MC Spike_Store_MC	Stream_Store_MC
Data Construct Type	Triggered Scalar Data List	Data Buffer Signal Snippets	Continuous Waveform
Description	single values	small waveforms	single waveform
Synchronous Asynchronous	synchronous across all channels	synchronous across all channels (snippets) asynchronous across all channels (spikes)	synchronous across all channels
Common signals or values	temperature, PH, spike rate, frequency, or level	evoked potentials snippet data spike data	spike activity (plot decimated), decimated, and raw waveforms

Note: the information provided here for storage macro selection is intended as a guideline; however, the stored event rates that can be achieved with each data construct may vary depending on the amount of data to be read back and the Master Polling Rate set in OpenWorkbench. To ensure that all data is stored without loss the maximum data transfer rate should not be exceeded.

Calculating Data Transfer Rates

The maximum throughput of the TDT system differs depending on the interface. *Refer to your System's User Guide for more information on the maximum throughput of your interface.*

Data acquisition that is near the maximum rate may cause more data to be acquired on the hardware device than can be transferred to disk. At that point the system will fail to store all the data and, if it continues for an extended period of time, can cause OpenWorkbench to stop acquiring any data.

To minimize the chance of exceeding the data rate, data should be acquired at rates that are no more than 90% of the maximum transfer rate. There is a fair amount of overhead associated with polling all of the hardware devices and rates that come close to the above transfer rate are likely to overflow.

How to Calculate Your Maximum Transfer Rate

The maximum transfer rate of your protocol is fairly straight forward. Transfer rate is rarely of concern when working with data with slow event rates, such as triggered scalars or events that are only acquired at the end of an acquisition such as an averaged signal. Streamed or snippet data that is acquired through out the experiment, however, may cause problems.

The maximum transfer rate for a snippet is calculated as:

Maximum number of events per second * Block size * Number of channels * Data type (Float, Byte, Single, I32, or I16). For example, if the maximum number events are 50 per second, the block size is 32 points, the number of channels is 16, and the data type is float, then:

Events = 50 per second

Block Size = 32

Channel Count = 16

Data Type = Float (4 bytes)

This yields the equation: $50 * 32 * 16 * 4 = 102,400$ bytes per second.

The maximum for streamed data is calculated as:

Compiled circuit file sample rate / Decimation factor * Number of channels * Data type

For example, if 16 channels of data are acquired at 25 kHz with no decimation and in Single format (16 bit), then:

SR = 24414.0625

Channel Count = 16

Decimation Factor = 1

Data Type = Single (2 bytes)

This yields the equation: $24414.0625 / 1 * 16 * 2 = 781,250$ bytes per second.

What about acquiring snippets and streamed data?

When acquiring multiple data types sum the total transfer rates. For example, if the data acquired was 16 channels of snippets and 16 channels of evoked potentials (1000 Hz sample rate) along with decimated waveforms the calculations might look like this.

Snippets:

Events = 50 per second

Block Size = 32

Channel Count = 16

Data Type = Float (4 bytes)

$50 * 32 * 16 * 4 = 102,400$ bytes per second

Streamed data:

SR = 24414.0625

Channel Count = 16

Decimation factor = 24 (generates 1000 Hz SR)

Data Type = Float

$24414.0625 / 24 * 16 * 4 = 65104$ bytes per second

Plot Decimated waveforms:

SR = 24414.0625

Channel Count = 16

Decimation factor = 64 (generates 1000 Hz SR)

Data Type = Single (remember 16 bit for each value)

$24414.0625 / 64 * 16 * 2 = 12,207$ bytes per second

Total transfer rate = 12207 + 65104 + 102,400 = 179,711 bytes per second

Data Storage with Macros

The most important part of running an experiment with OpenEx is saving the experimental data. To correctly save data, the data constructs in RPvdsEx (buffers for collecting the data, etc.) must be carefully configured. RPvdsEx includes a number of data storage macros designed specifically for OpenEx. Using these macros simplifies circuit design and ensures smooth integration with Workbench.

Tip!: More information about each macro is available in its onboard help. To access that information, add the macro to an RPvdsEx circuit and double-click the macro icon to display the macro properties and help.

Scalar Data

Scalar data is commonly stored for stimulus variables and time references and is primarily used as reference data for epochs. See *About Epoch Events*, page 81 for more information.

Epoc_Store macros



The **Epoc_Store** macro is useful for experimental protocols that require several secondary tags that reference a primary store.

The **Epoc_Store_1-4Ch** macro stores scalar data according to a rising trigger edge. It is useful for simple scalar recording.

The **Epoc_Store_with_Offset** offers the same functionality of the **Epoc_Store** macro but also allows buddy epochs to be set. For more information see *About Epoch Events*, page 81.

Uses: The **Epoc_Store** macros are typically used to store scalar values, such as stimulus variables.

Description: **Epoc_Store** macros store an Epoch value on the rising, falling or either edge of the selected trigger.

Users can choose to use the macro Trigger input, the onset of each system sweep, or whenever the value of the primary input changes as the trigger. Up to four secondary Stores can also be enabled to store other values on each trigger which reference the primary store.

Secondary Tags

Secondary tags are a way of sharing time stamps between data Stores and are defined in the Stores section of OpenWorkbench. In some cases there are multiple pieces of data that are always stored at the same time. For example, stimulus parameters such as amplitude and frequency might need to be saved once per sweep. In these situations, it is convenient to use Secondary Tags.

Many data saving macros allow secondary tags to be configured easily, requiring only the primary store to be specified. For example, the Epoc_Store macro offers up to four secondary tags to be stored in reference to its primary store. After the primary Store is enabled, secondary tags can be added for each of the other Stores that will share time stamps with the primary Store. The data types of the primary Store and any associated secondary tags are the same.

Slow_Store macros



The **Slow_Store_1-4Ch** and **Slow_Store_1-8Ch** macros are compatible with TDT's single processor devices.

The **Slow_Store_MC** macro is supported only by multiprocessor devices such as the RX5 and RZ2.

Uses: **Slow_Store** macros are used for storing scalar data such as stimulus parameters and digital input values. They can be used to record stimulus parameters time stamped to a subject response or other external event.

Description: **Slow_Store** macros provide triggering based on an internal sampling rate or external trigger rather than triggering related to the system sweep or stimulus value change. They will accept floating point or fixed point data streams and one sample point will be stored for each channel of data at the rising edge of the trigger input when the enable line is true.

Discrete Data

Discrete data is commonly found in the form of snippet waveforms, or block waveforms. Discrete data is useful in spike sorting as well as averaging since it can be time stamped and referenced to segments and events.

Block_Store macros



The **Block_Store_1-4Ch** and **Block_Store_1-8Ch** macros are compatible with TDT's single processor devices.

The **Block_Store_MC** macro is supported only by multiprocessor devices such as the RX5 and RZ2.

Uses: **Block_Store** macros are used to store snippet data, but do not include any spike detection or sorting.

Description: **Block_Store** macros store snippets in relation to a trigger, giving the user the option to shift storage in relation to the trigger. They will accept floating or fixed point data for block storage at a specified sample rate. The number of points saved (block width) can also be set by the user.

Spike_Store macros



The **Spike_Store_1-4Ch** macro is compatible with TDT's single processor devices.

The **Spike_Store_MC** macro is supported only by multiprocessor devices such as the RX5 and RZ2.

Uses: **Spike_Store** macros are used to store data snippets, such as spike waveforms, and incorporate several methods of threshold detection and spike sorting.

Description: Spike snippet width and spike detection and sorting method (Processor Type) are defined in the setup properties. Thresholding and sorting are controlled by the user through OpenController, using the Scrolling Threshold and Snippet Sort controls. The macro provides the necessary controller targets (parameter tags) depending on the Processor Type chosen.

Choosing a Spike Component

OpenEx supports four spike acquisition components, typically implemented through a Spike_Store data saving macro. Users can select which component (or processor type) is used in the macros set-up properties.

The SortSpike2 component should be appropriate for most spike discrimination and spike sorting applications. However, there may be rare instances where choosing one of the other available spike components could provide better performance.

TDT strongly recommends using the SortSpike2 whenever possible. All four components can be used with the Scrolling Threshold control for spike discrimination. However, FindSpike cannot be used with the Signal Snippet Control for online spike sorting. This section provides a table for comparison of the four spike detection components followed by discussion of how they differ and when to use them.

The following table compares the different processor types, their uses, and specifications.

Issue	FindSpike	SortSpike	SortSpike2	SortSpike3
Threshold	value between two RMS windows	value between two voltage windows	value above a set voltage threshold (threshold can be bimodal)	value above a set voltage threshold (threshold can be bimodal)
Windowing	peak of spike centered in buffer	peak of spike centered in buffer	threshold crossing placed at 1/4 point of the buffer	threshold crossing placed at 1/4 point of the buffer
Biphasic Spikes	yes	no	yes	yes
Spike Sorting	none	time-voltage spike sorting	time-voltage spike sorting	time-voltage spike sorting
Time Stamp	yes	yes	yes	yes
Time Stamp Position	center of buffer	center of buffer	1/4 mark of the buffer	1/4 mark of the buffer
Buffer Description	buffer size is determined by defining a value that equals the total size of buffer including a time stamp	buffer size is determined by defining a value that equals half the size of the buffer including time stamp and sort spike code	buffer size is determined by defining a value that equals 1/4 of the size of the buffer including the time stamp and sort spike code	buffer size is determined by defining a value that equals 1/4 of the size of the buffer including the time stamp and sort code
When To Use	when there is no need for spike sorting and the noise floor of the signal might vary greatly (users can set up a second threshold to reject artifacts)	when spike sorting is required or if the spike rate might affect the RMS of the signal when windowing must be used to minimize stimulus artifacts	same as for SortSpike except there is no artifact rejection when spikes that exceed above an absolute threshold value must be detected	when the sort code needs to be based on all of the time-voltage windows that the waveform passes through
When Not To Use	when spike sorting is required or if spike trains increase the RMS	when circuits that can easily be used with BrainWare or custom ActiveX applications are desired		when more than four time-voltage windows are used (four windows will generate 2^4 or 16 distinct sort codes)

FindSpike

The FindSpike component differs from the SortSpike components in two significant characteristics: FindSpike does not allow online spike sorting and it does not use a fixed voltage threshold for spike discrimination. Users who require online spike sorting should use one of the SortSpike components. If online spike sorting is not required, FindSpike can be used and has some advantages for acquiring candidate spikes. FindSpike detects spikes based on their deviation from the noise of the system. The noise floor of the signal is determined by calculating the RMS of the last x number of milliseconds (τ). If the noise floor of the signal changes over the acquisition period FindSpike will track the changes and compensate for variations in the noise floor. As long as the signal to noise ratio between the noise floor and the spikes remains constant, or relatively so, the candidate spikes should be easily acquired. In contrast, the SortSpike components use a fixed voltage threshold. If the noise floor changes (even if the signal to noise ratio of the spike does not change) there is a potential to lose candidate units or to acquire signal artifacts. One problem with using the RMS of the noise floor is that it is affected by changes in unit activity. A spike train may change the calculated RMS value and thereby decrease the chance of acquiring all the spikes in a train using this method. If the firing units cause a significant change in the RMS a SortSpike2 (or similar) component should be used.

SortSpike and SortSpike2

SortSpike and SortSpike2 were designed primarily for use with OpenEx applications and allow online real-time spike sorting through OpenController. Signals that cross a fixed voltage threshold (window discriminator) are considered as candidate spikes. Units whose waveform also falls within a voltage range during a specified time window are given a unique sort code while units that do not pass through any of the time voltage windows are assigned an unclassified code. Because SortSpike and SortSpike2 use a fixed voltage window discriminator, spike trains during the onset or offset of a stimulus should not affect the systems ability to acquire unit activity. However, if the noise floor of the signal changes, it may be necessary to change the threshold settings on a regular basis to ensure a proper signal to noise ratio.

SortSpike and SortSpike2 differ in how the captured signal is stored in the buffer. SortSpike, like FindSpike, centers the peak of the waveform and uses this value as the time stamp for the signal. The position of the discriminator does not affect the position of the waveform in the buffer. Because SortSpike and FindSpike use the peak of the signal as the center, variation in signal amplitude due to the ambient background noise may shift the true peak of the waveform. This jitter will cause minor variation in the time stamp of the signal and may affect the acquired signal since the position of the waveform is dependent on the peak signal. The noisier the signal, the greater the effect.

The time stamp and position for of the waveform for SortSpike2 is dependent on the time of the threshold crossing for the signal. This has two effects on the positioning of the signal in the buffer. First, signals that differ in shape may have their peaks at different positions in the buffer.

If it is important for the time stamp to be relative to the peak of a waveform then it may be necessary to calculate a new time stamp offline. Second, changing the position of the discriminator will affect the positioning of a signal in the buffer. For example, setting the signal to noise of the threshold relatively low (1.2:1) shifts the time stamp to an earlier point (since the signal crosses the threshold earlier) and shifts the peak to a later point. As the position of the threshold becomes closer to that of the peak, the time stamp for SortSpike and SortSpike2 become more similar.

In addition, SortSpike2 allows users to set a bimodal threshold. This allows users to sort spikes that differ in both shape and direction of the peak. However, it does not allow users to reject stimulus artifacts (which both SortSpike and FindSpike allow). If users plan to use electrical stimulation it may be necessary to use SortSpike or FindSpike so that signal artifacts can be removed.

SortSpike3

SortSpike3 is a modified version of the SortSpike2 component. The only difference between the two components is the generation of the sort code. See Determining Sort Code, page 162 for more information.

Each of the spike discrimination components has advantages and disadvantages. Users should select a component based on their research needs.

Continuous Data

Continuous data found in OpenEx is typically streamed with a time reference only to the start of the block. Continuous data can be stored in several data formats and is useful for observing plot decimated data (spike activity), raw waveforms, and decimated waveforms.

Stream_Store macros

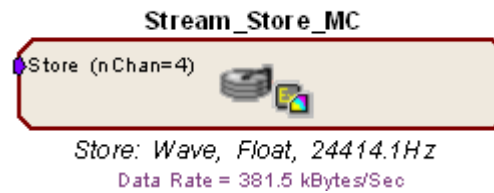
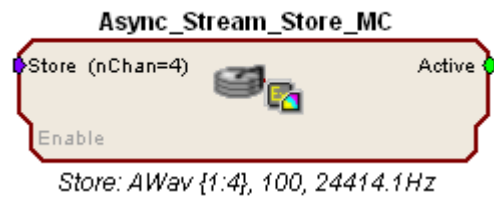

The **Async_Stream_Store_MC** and **Async_Stream_Store_1-4Ch** macros are supported only by multiprocessor devices such as the RX5 and RZ2.

The **Stream_Store_1-4Ch** and **1-8Ch** macros are compatible with TDT's single processor devices.

The **Stream_Store_MC** macro is supported only by multiprocessor devices such as the RX5 and RZ2.

The **Stream_Store_MC2** macro is supported only by multiprocessor devices such as the RX5 and RZ2 and is an extremely efficient data storage macro. Cycle usages for saving data are reduced by saving streamed data from all channels as one collective stream instead of parsing individual channels. Visualization in OpenController is not supported since individual channels are not separated until the data is stored to the tank.

Uses: **Stream_Store** macros are used to store streaming raw, filtered, or decimated waveforms. **Async_Stream_Store** macros are used to store streaming raw, filtered, or decimated waveforms through an asynchronous enable at a specified sample rate.

Description: **Stream_Store** macros accept floating point data streams for storage at a specified sample rate. Depending on the Store Format parameter setting, one of five data formats will be used for storage; 32-bit floating point, 32-bit integer, 16-bit integer (Short), 8-bit integer (Byte), or 32-bit integer for plot decimation.

Async_Stream_Store macros are similar to the **Stream_Store** macros but allow storage to be triggered asynchronously through an enable.

OpenController Constructs

Biquad Filtering

Biquad filtering can be implemented using one of the filtering macros available in RpvdsEx.

HP-LP_Filter_1Ch, **HP-LP_Filter_4Ch**, and **HP-LP_Filter_MC** macros pass floating point data through cascaded highpass (HP) lowpass (LP) filter sections.

Butterworth filter coefficients can be updated through the macro properties dialog, through parameter tags via software control or dynamically through direct connections to the FreqHP and FreqLP macro parameter inputs (when enabled).

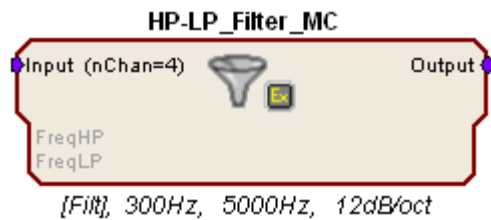
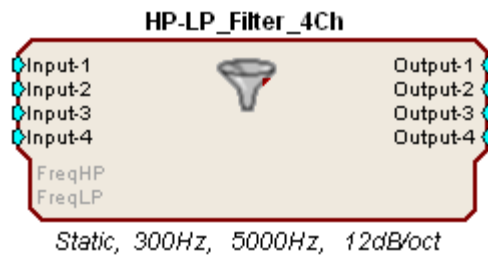
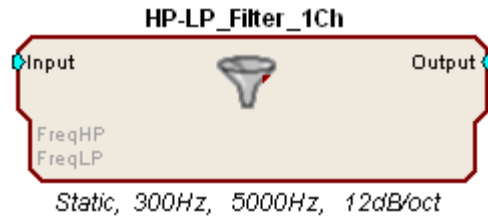

OpenWorkbench Reference

In the OpenWorkbench Reference you will find:

A reference guide to OpenWorkbench including an introduction to important concepts, the Workbench workspace, the basics of configuring and experiment, and running an experiment using the system controls.

Configuring an Experiment

Step-by-step guide to configuring a project with reference details.

~

About OpenWorkbench

OpenWorkbench is a flexible application for running and designing experiments. OpenWorkbench uses compiled circuit files to control System 3 hardware and funnels acquired data to OpenEx's TTK data server for fast indexing and storage. Configuration files (.xpm) include information about device configuration, data storage, and the experiment timing and control. Several OpenWorkbench configuration files are provided as part of the Examples so users can get started with common experimental paradigms right away. As users become more familiar with OpenWorkbench they can modify those configuration files or design their own. The OpenWorkbench interface is streamlined so that the most frequently utilized features are in view. A menu bar is also provided for easy access to additional commands.

The Main Window displays device configuration details and storage specifications during set-up and toggles to plotting during data collection or preview. ↓

The Device Navigator provides a drag and drop interface for configuring the devices in your system. →

The System Control window provides control over running protocols. →

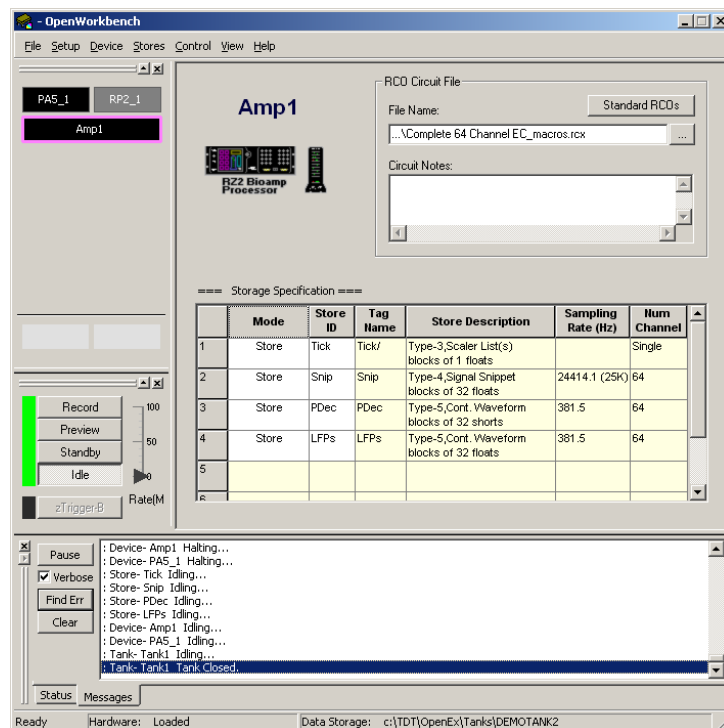

↑
The Messages window displays status information and error messages.

Record Mode →

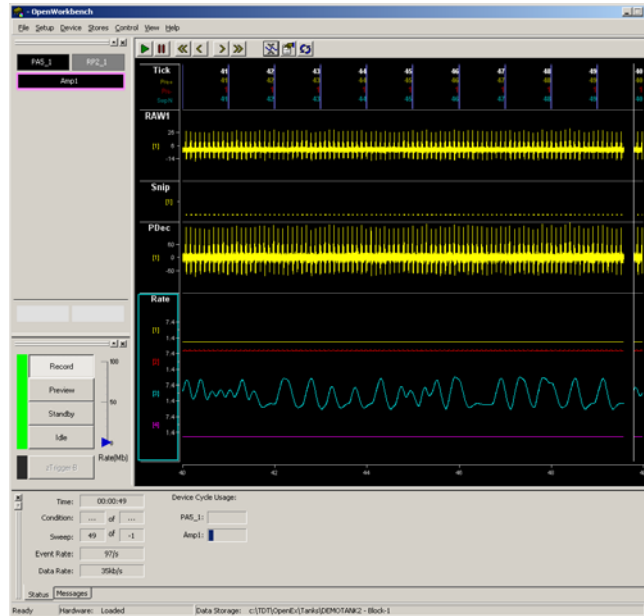

Understanding OpenEx Data Stores

OpenEx experiments can acquire and store various types of data in a single data tank. For example, an experiment might acquire both spike waveforms and the scalar values of a stimulus variable. Each type of data to be acquired during an experiment is called a Store. Each Store is defined by a data construct within the compiled circuit file. When a compiled circuit file is assigned to a selected device, the Store information, including data type and number of channels, is displayed in the storage specification table. Data constructs are groups of components within a circuit that provide information to OpenWorkbench on how to store data to the tank. OpenEx recognizes five distinct data constructs but all data can be categorized into three basic data types: scalar values, discrete waveforms, and continuous waveforms.

Scalar Values

Scalar events are typically things such as temperature, PH, or spike rate. Scalar events that are marked as epochs in OpenEx allow users to sort and visualize data that is associated with a particular event. For example, if the stimulus frequencies are stored as an epoch scalar then the user can quickly sort data and view all data acquired with frequencies above 4000 Hz. Scalar values can be stored using either the Store inputs associated with the control macros or using the `Epoc_Store` or `Slow_Store` macros. When macros are not used, scalar data is saved using a `Triggered Scalar` or a `Data List` data construct.

Discrete Waveforms

Discrete waveforms, or fixed block events, are small chunks of data (<1000 samples). They are typically things such as acquired spikes or evoked potentials. Users can store this type of data using either a `Spike_Store` or `Block_Store` macro. When macros are not used a `Data Buffer` or `Signal Snippet` data construct can be used.

The Spike_Store macro is used when spike detection and/or sorting is needed and Block_Store is used when it is not. Each of these macros can acquire fast data, signals that occur at rates greater than once a second and store separate time stamps for each channel (asynchronous storage).

It is important to note that block sizes must be small enough and infrequent enough so that a maximum data throughput of 200,000 samples per second is not exceeded.

If the size of the block is large and there are multiple channels it is possible to attempt to store more data than can be transferred. See Calculating Data Transfer Rates, page 67 for more information.

Continuous Waveforms

Continuous waveforms are acquired without interruption from the beginning to the end of the acquisition block. Acquired data has a fixed number of samples per second, which is based on the sampling frequency of the device and the decimation factor of the acquired signal. The Continuous Waveform construct has several features that differentiate it from other data types. First, the construct does not have its own time stamp. All data types are defined relative to the start of the block. If there is any disruption of the acquired signal, the data tank will generate errors about storing data to a data block. For example, if a user wanted to acquire a large block of data only when a particular event occurred they should use a Data Buffer and not a Continuous Waveform. Second, streamed data requires only one sync for all channels. This is because the data acquisition is synchronous across all channels.

Continuous acquired data comes in three formats:

Plot decimated data - the maximum and minimum of a block of data is determined and stored as a single 32-bit word. Data in this format allows users to visualize the maximum noise floor and spike activity of an incoming signal; however, it is not a true representation of the acquired signal.

Continuous undecimated data - signals that are acquired at the sampling rate of the RPvdsEx circuit. The acquired signal in this format should be streamed at a sample rate that will be below the maximum transfer rate of the hardware.

Continuous decimated data - signals that are acquired and filtered and then decimated. The decimated signal is then stored to a buffer.

All three continuous waveform types can be acquired using the Stream_Store macros.

For more information about data storage see Data Storage Macros, page 66 and About Control Constructs, page 65.

About Epoch Events

Epochs are sections of tank blocks that are associated with the tank's timeline. They identify the start, stop, or duration of particular event periods. For example, an epoch could be associated with a stimulus presentation period and could identify a pre-stimulus, stimulus, or post-stimulus period. Because epochs are automatically indexed by TTank as they are stored, other events can be referenced against them. OpenBrowser and OpenScope use epoch values to display and edit tank data. For example, epoch events can be used as the reference for creating histograms and rasters. They can also be used by OpenBrowser to view and export data with reference to the epoch events.

Epoch events can be scalar variables including triggered scalars, data lists, and their associated secondary tags. They can be of a set or variable length depending on the triggers and sync tags used within the data construct. An epoch can be used to identify the period of a sweep, the duration of a stimulus, the duration of the acquisition, or be independent of the sweep and acquisition properties of the system. For example, an epoch can be set when an event, such as a button press or an update of a stimulus paradigm from OpenController, occurs.

Epoch events can be continuous or intermittent and are marked as sections within a block. Each section is associated with a scalar value. Standard strobed events are continuous. That is, when one epoch ends the next begins. The strobe type (ONset or OFFset) determines whether the time stamp occurs at the start or the end of the epoch. Two epoch Stores, one ONSET and the other OFFSET can be declared as buddies to create an epoch that is not continuous. This creates a single epoch that starts at the occurrence of the ONSET epoch and ends at occurrence of the OFFSET epoch.

For example:

Store	Strobe Type	Buddy Epoch:
'Pre+'	ONset Strobe	
'Pre-'	OFFset Strobe	'Pre+'
'SwpN'	ONset epoch	

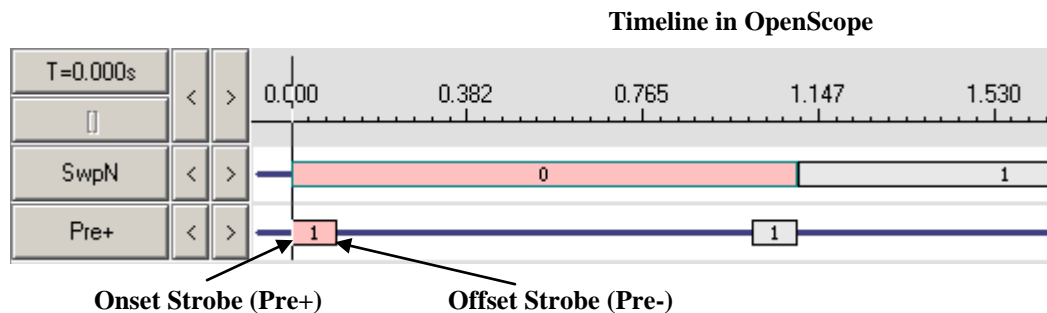

Using buddy items will decrease the size of the tank and minimize storage of extraneous information.

Creating Epochs

A Store that includes a sync and time stamp parameter can be set as an epoch event in OpenWorkbench by setting the Strobe Type parameter in the Storage Specification Table (you might have to right click and select Show All Fields to view this data column). The strobe type determines whether the time stamp occurs at the start or the end of the epoch.

About Tanks

As data is acquired it is passed to a powerful data server. The data server, TTank, indexes and stores the data then makes the data available to other client applications in the OpenEx suite. Users can create a base name that will be assigned to each block of data acquired in the selected tank.

Data Tank Formats

DataTanks and blocks are treated as folder/file structures. Each new data tank acts as a folder that contains multiple block folders. The four files (.tbk, .tdx, .tev, .tsq) associated with each block are

stored within each block folder. Tanks and blocks can be browsed and managed just as you would with other Windows-based folders and files. Individual blocks can be deleted or transferred between tanks using standard Windows Explorer methods. However, the underlying file structure for each block should always be maintained. If a block must be moved, move the block folder. Never move or delete an individual .tbk, .tdx, .tev, or .tsq file. Blocks and files are named with a consistent naming structure to help keep blocks intact.

The following figure shows a Windows Explorer view of a tank folder and its corresponding blocks. Note the identifying tank and block icons.

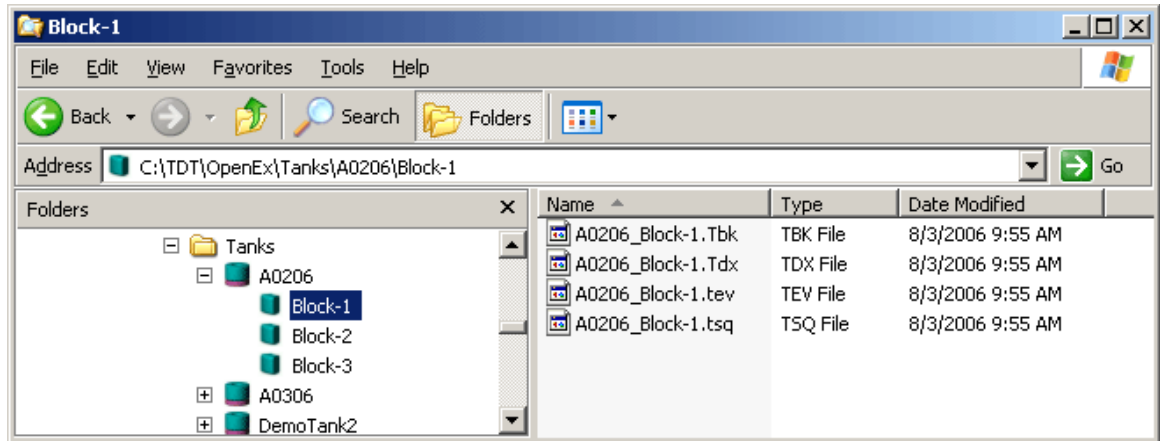

You can create new tanks or open existing tanks in the Data Storage dialog box, available from the Data Tank command on the File menu in OpenWorkbench.

Legacy Tanks

OpenEx 2.0 supports the 'legacy' DataTank structure used in earlier versions of OpenEx, but strongly recommends using the more manageable and portable DataTank structure that is the default format in the current release. The 'legacy' tank structure does not provide easy access to add, move, or delete individual blocks within the tank from Windows Explorer.

Registering Tanks

If a tank will be accessed across a network, it must be added to the windows registry. Tanks can be registered or unregistered with a single click from the Data Storage dialog within OpenWorkbench or from TankMon.

Note: there is a limit to the number of tanks that can be registered at one time.

Workspace Basics

Using the Device Navigator

The Device Navigator provides a drag and drop interface for configuring the devices in your system. On launch, OpenWorkbench automatically detects all TDT programmable hardware modules that are powered on and connected to the PC and generates a system diagram in the Device Navigator window. The devices are displayed in the top half of the window. Clicking a device icon displays configuration information for that device in the Main Window. Devices are configured (with processing chain and storage specifications) by assigning a compiled circuit file.

Device icons that are colored gray indicate that they have not yet been assigned a configuration, those in black indicate that configuration is complete.

If you load an existing project, OpenWorkbench attempts to match device configurations saved as part of the Workbench file with the hardware detected. Any configurations that are not matched to a device are displayed in the bottom section of the navigator. To assign or move configurations between devices, simply drag the configuration icon to the desired device icon.

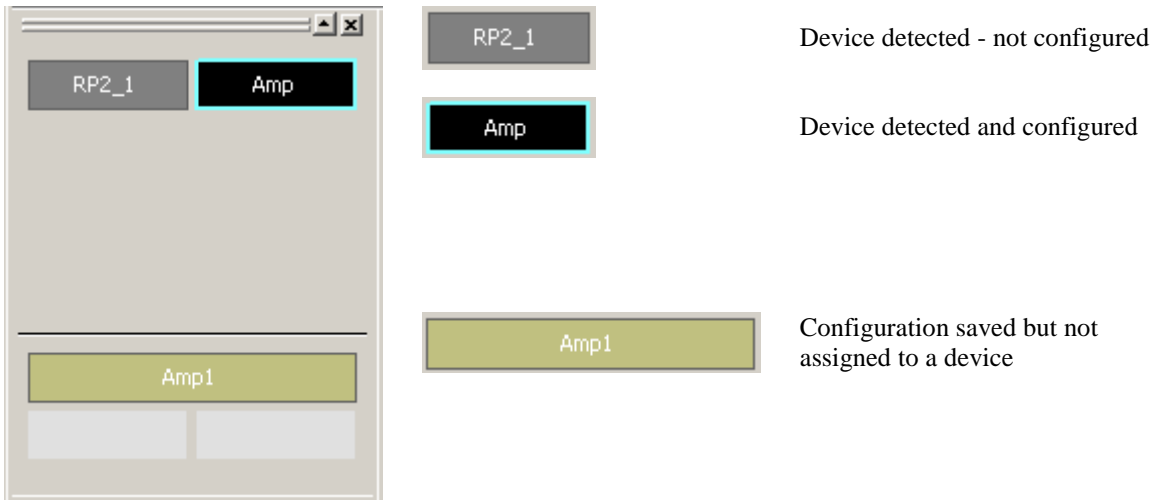

The Device Navigator is a sub-window that can be floated, moved, collapsed, or hidden. By default, it is located in the upper left corner of the WorkBench window.

Using the System Controls

The OpenWorkbench system controls allow the user to start or stop the experiment from the PC and preview data as it is being collected. The System Control window also provides status information about the system. The control set includes a system status indicator, control buttons, an event rate indicator, and a trigger button.

Protocol Control Buttons

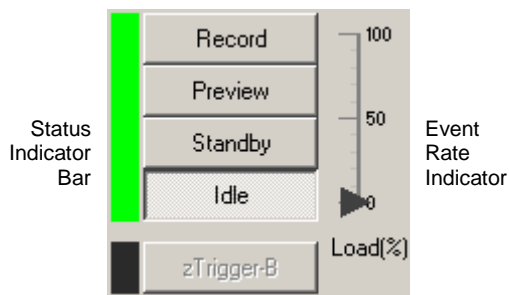

ZBus(B) Trigger Button

Event Rate Indicator

The Event Rate indicator is a vertical scale and arrow to the right of the control buttons. The arrow indicates the rate of events being stored to the tank. The arrow changes color from blue, to amber, then red to alert the user when the event rate is high. If the event rate is high, the user should check

and adjust threshold settings and other event criteria to ensure that the maximum event rate is not exceeded. Data will be lost if the maximum event rate is exceeded.

Status Indicator Bar

The Status Indicator Bar flashes green when the system is running in Record or Preview mode without errors. The bar will flash red when errors occur.

Control Buttons

The control buttons allow the user to run or halt the experiment.

Record	devices are loaded and running and data is saved to the tank
Preview	data is saved to a temporary block in the tank <i>Users can examine data in both OpenScope and OpenController. This allows users to modify parameter values before starting the experiment.</i>
Standby	devices are loaded and running but signals are not being acquired and saved to disk <i>This allows the user to modify parameter values through OpenController.</i>
Idle	devices are not loaded and are not running <i>Switching to Idle mode resets Control values to their defaults.</i>

When Record or Preview is selected, the plot window is displayed in the main window area and status information is displayed in the message window area.

By default, the system will automatically switch to Idle mode if 100 errors are reported in a single recording session. The error counter is reset for each new recording session. The number of errors can be set in the OpenWorkbench Preferences dialog box.

zTrigger-B Button

This option is activated when the **Use zTrgB** check box is selected under **Triggers and Mode Switching** on the Workbench setup menu.

When the zTrgB button is illuminated, pressing it will start a conditional trial or trigger any event on devices that have the zTrigB line enabled.

Using the Messages Window

When OpenWorkbench is running, the Messages window displays a scrolling list of OpenWorkbench messages. You can double-click any message to display the full message in a message box. Messages may contain information about OpenWorkbench activity, TTank activity, or system errors. Error messages provide the user with details about the error.

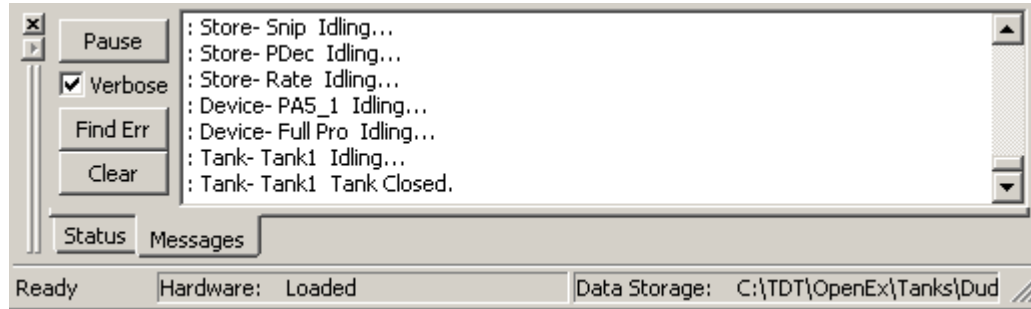

Pause

The Pause button freezes the appearance of the Messages window to allow the user more time to read displayed messages. Message scrolling resumes when the Pause button is clicked again.

Verbose

The Verbose check box toggles verbose messaging on and off. When the check box is cleared, only mode change and error messages are displayed. By default, verbose messaging is not enabled. The default can be changed in the OpenWorkbench Preferences dialog box.

Find Err

The Find Err button scrolls through error messages in the message list. Each time the button is clicked the next error message is highlighted in the Messages window.

Clear

The Clear button, removes all messages from the Messages window.

Using the Plot Window





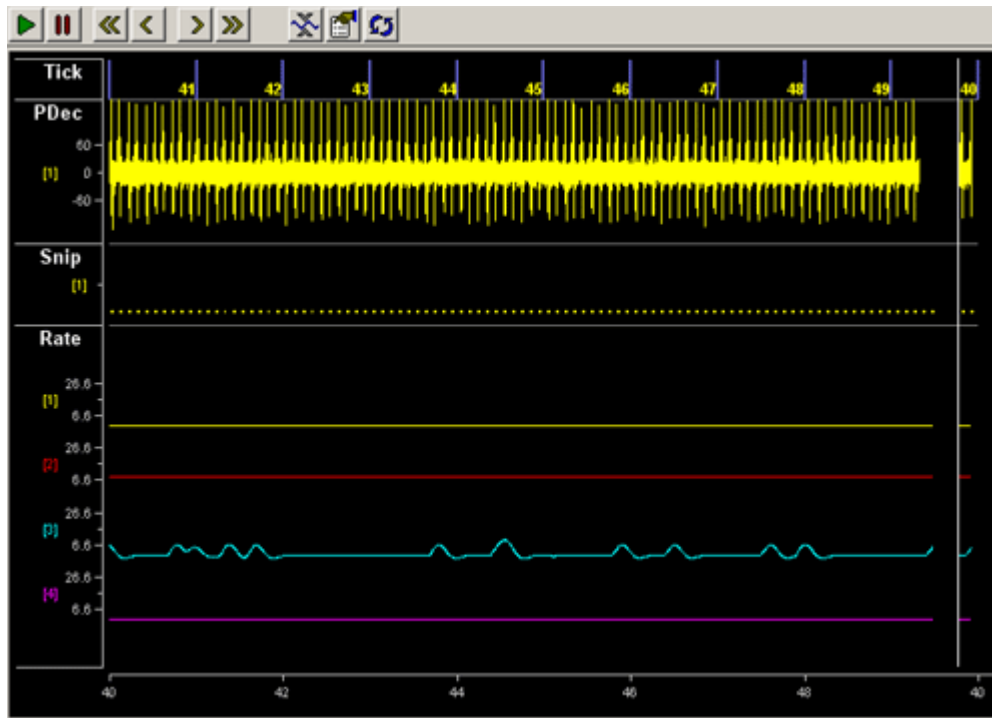



If the OpenWorkbench preference Enable Data Monitoring is checked, the plot window is automatically displayed when a project is run in OpenWorkbench. Users can also toggle the window off or on from the View menu.

In Preview and Record modes, OpenWorkbench generates a plot set for fast, easy visualization of data. Workbench automatically chooses a plot type and configuration for each data set, but users can adjust the configuration for each plot to refine the display.



A toolbar at the top of the plot window allows the user to control plot animation.



-  Play
-  Pause
-  Scroll back by plot window width (e.g. if span is set to 60 seconds, this button will scroll back in 60 second chunks)
-  Scroll back (increments of span/10)
-  Scroll forward (increments of span/10)
-  Scroll forward by plot window width
-  Auto Scale
-  Data Monitor Setup (launched dialog)
-  Refresh

Additional commands for scaling, shifting, or moving plots are available from a right-click shortcut menu.

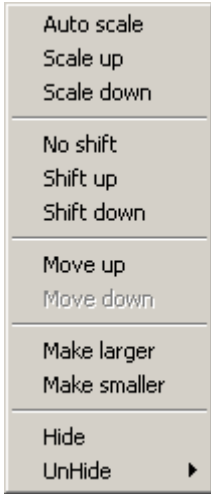

- Auto Scale** Scale the display so that it best fits in the available subplot area.
- Scale Up/Down** Incrementally scales the display up or down.
- No Shift** Removes any offset that was placed on the display in the subplot window.
- Shift Up/Down** Shifts the display up or down in the subplot window.
- Move Up/Down** Moves the subplot up or down in the Plot Window view.
- Make larger/smaller** Makes the available subplot area larger or smaller. The other plots are resized accordingly.
- Hide/UnHide** Makes the available subplot area larger or smaller. The other plots are resized accordingly.

Users can change the plot type, modify the number of channels viewed, and choose to color traces by channel or sort code in the Display Options dialog. To modify the display options, double-click the desired sub-plot.

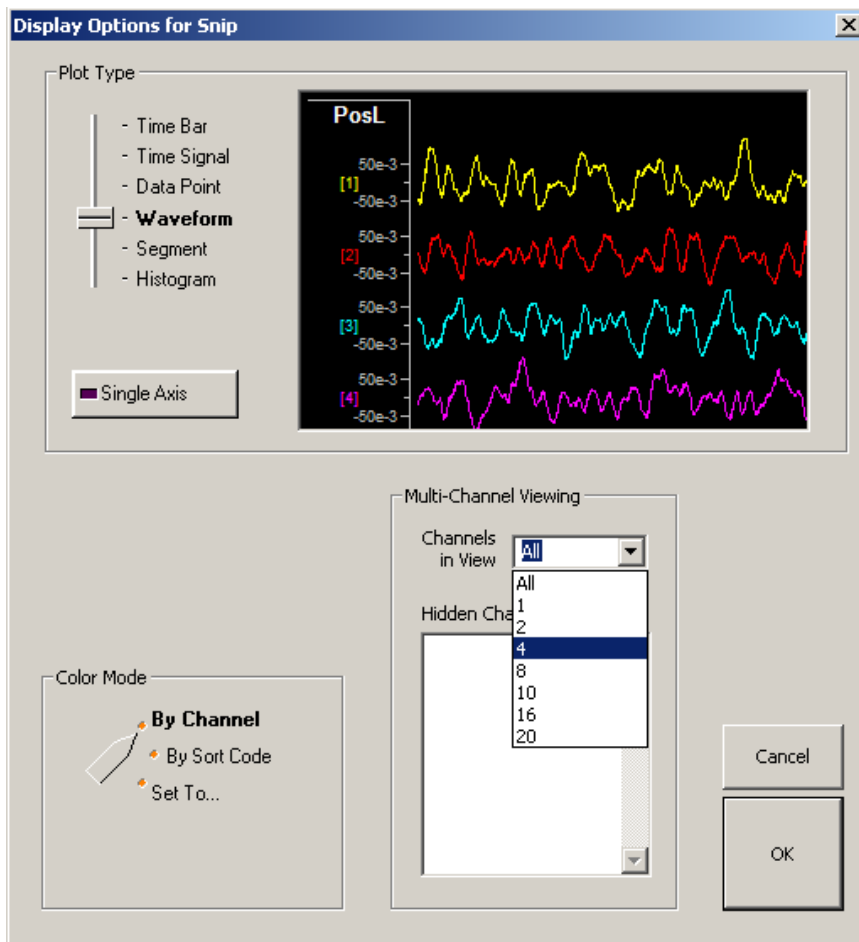

Users can change settings related to the time span and tracking of the plot window in the Data Monitor Setup. To view data monitor settings for the plot, click the  Data Monitor button on the plot toolbar.

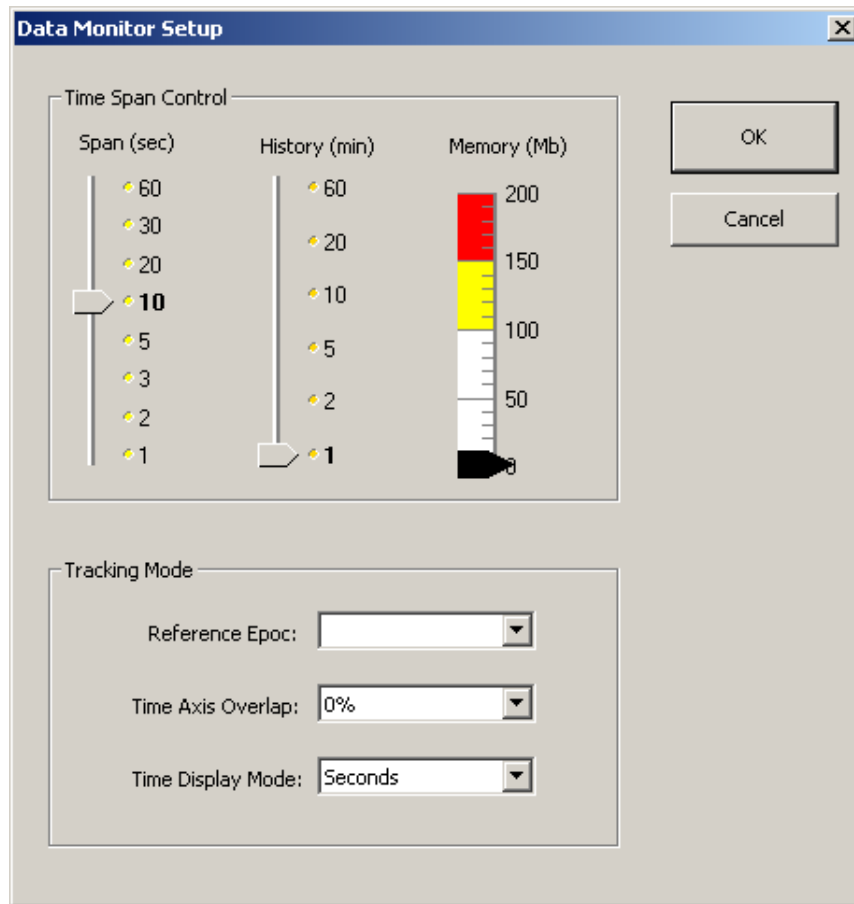

Time Span Control

Span - Set the span (sec) of the plot window

History - Determine how much plot history will be stored for viewing purposes.

Note how the memory requirements change as these settings are adjusted.

Tracking Mode

Reference Epoc - If a reference epoch is used, the left side of the Plot Window will always coincide with the start of the reference epoch.

Time Axis Overlap - Set the amount of the time axis that is repeated when the plot rolls over. For example, if the span is 10 seconds and Time Axis Overlap is set to 50%, the plot will show seconds 0-10, 5-15 etc.

Time Display Mode - Set the display units of the time axis

More Settings

Press Shift + Ctrl and double-click the dialog box to display additional settings for the plot appearance, such as background color and labels.

OpenWorkbench Preferences

This dialog box is available from the File menu.

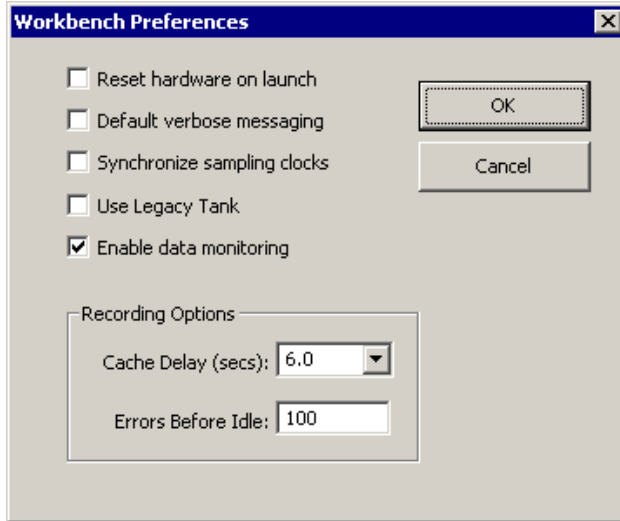

Reset hardware on launch

When the check box is selected, any attached System 3 hardware will be reset whenever OpenWorkbench is launched.

Default verbose messaging

When the check box is selected, verbose messaging is the default view for the Messages window. When cleared, only error and mode change messages will be displayed, by default. Verbose messaging can be turned on or off, for the current session only, at any time from within the Messages window.

Synchronize sampling clocks

When this preference is checked, the zBusA trigger is used to synchronize the sampling clocks of all connected devices.

Note: Not supported by RZ Processors.

Use Legacy Tank

When this box is checked, the OpenWorkbench Data Storage Dialog will use the Legacy tank view and right-click menu.

Enable data monitoring

This preference enables or disables the OpenWorkbench plotting function.

Recording Options

Cache Delay (Seconds)

This value relates to the size of the OpenWorkbench temporary memory buffers. Although a higher setting requires more system RAM, it provides less susceptibility to data storage errors.

Errors Before Idle

Set the number of reported errors that will cause OpenWorkbench to switch to Idle mode. The count is restarted each time OpenWorkbench is switched to Record mode.

OpenWorkbench Menus

OpenWorkbench File Menu

Some Items on the OpenWorkbench File menu are not available when running in OpenProject.

New Configuration	Opens a new OpenWorkbench file.
Open Configuration	Opens the Open dialog box so that an existing OpenWorkbench file can be opened.
Save Configuration	Saves the current OpenWorkbench file with the current name. If the file has not previously been saved the Save As dialog box opens so that the file can be named.
Save Configuration As	Opens the Save As dialog box so that the OpenWorkbench file can be saved with a new name.
Data Tank	Opens the Data Storage window so that a tank can be assigned for data storage. An existing tank can be selected or a new tank can be created.
Recent File	The third section of the File menu lists recently used files. Clicking a file name opens the file.
Preferences	Opens the Workbench Preferences dialog box.
Exit	Closes the OpenWorkbench application.

Note: To save changes to a file that is part of an OpenEx project, save the project.

OpenWorkbench Setup Menu

The Setup menu provides access to settings used to control how stimuli are presented and how data is acquired. Default settings are suitable for the most basic experimental protocol, continuous acquisition.

Polling and Performance	Opens the Polling and Performance dialog, allowing users to set how often OpenWorkbench polls devices for new data.
Triggers and Mode Switching	Opens the Triggers and Start/Stop Timing dialog.
Sweep Loop	Opens the Sweep Loop dialog, for access to sweep loop settings.
Condition Loop	Opens the Condition Loop dialog, for access to condition loop settings.
Stimulation Timing	Opens the Stimulation Timing dialog, where users can enable stimulation timing settings.
Acquisition Timing	Opens the Acquisition Timing dialog, where users can enable acquisition timing settings.

Timing and control settings are carried out through parameter tags that are included in various circuit constructs included in the compiled circuit file (compiled circuit) running on the System 3 hardware.

This approach allows the user to make adjustments to the experimental protocol without redesigning the circuits each time a change is desired. For more information about control circuit constructs see the Circuit Construct Reference, page 111.

Note: To save changes to a file that is part of an OpenEx project, save the project.

OpenWorkbench Device Menu

Important!: select the desired device in the Device Navigator before using the Device menu commands.

Assign RCO	Opens a Set compiled circuit file dialog box where users can browse to a compiled circuit file and assign the file to the selected device.
Rename	Opens the Rename Device dialog, allowing users to enter a meaningful name for the selected device. The device name is used to identify the device in other OpenEx clients such as OpenController.
Clear	Clears the current configuration for the selected device, effectively disabling the device until another compiled circuit file is assigned.

Device menu settings are also available in the Device Navigator from a right-click shortcut menu.

OpenWorkbench Stores Menu

Options are available from the Stores menu to synchronize Stores, change the display of the Storage Specification table and initialize targets. The same options are also accessed by right-clicking in the Storage Specification table.

Important!: select the desired device in the Device Navigator before using the Stores menu commands.

Refresh Stores	Resets all Store properties for the selected device, repopulating the Storage Specification table with information gathered from the control file. Changes made in the Storage Specification table.
Store Synchronization Off	Toggles Store Synchronization on or off. When Store Synchronization is off (checked), the Stores will not be updated if changes are made to the control circuit.
Show All Fields	Displays additional field in the Storage Specification table.
Other Options	Displays the Advance Settings dialog, allowing users to change sampling rates or initialize parameter values.

OpenWorkbench Control Menu

The commands on the control menu allow the user to start or stop the experiment from the PC and preview data as it is being collected.

Idle	Changes the system to Idle mode. <i>In Idle mode devices are not loaded and are not running.</i>
Standby	Changes the system from Record or Preview modes to Standby mode. In Standby mode devices are loaded and running but signals are not being acquired and saved to disk.
Preview	Changes the system to Preview mode and displays the Plot window. In Preview mode data is saved to a temporary block in the tank.
Run	Changes the system to Record mode and displays the Plot window. In Run mode devices are loaded and running and data is saved to the tank.
Reset Hardware	Resets the connected System 3 hardware.

OpenWorkbench View Menu

The commands on the view menu allow the user to toggle various display options.

Device Navigator	Toggles display of Device Navigator
Control Panel	Toggles display of Control Panel
Message Window	Toggles Display of Message Window
Plot Window	Toggles Display of the Plot Window

OpenWorkbench Help Menu

The command on the help menu displays version information.

About OpenWorkbench	Toggles display of OpenWorkbench version information
----------------------------	--

Configuring an Experiment

Configuring a Device - Assigning a Compiled Circuit File

The RCO circuit file area of the OpenWorkbench main window allows users to configure each device in the system by selecting a compiled circuit file, designed for use with OpenEx or other TDT applications. The System 3 real-time processing modules are controlled using these files, which are compiled from circuits designed using TDT's RP visual design studio (RPvdsEx). Users can generate their own compiled circuit files for use with OpenEx or select one of the Example compiled circuit files provided by TDT.

RCO Circuit File Area

The RCO circuit file area is used to assign a compiled circuit file to a device.

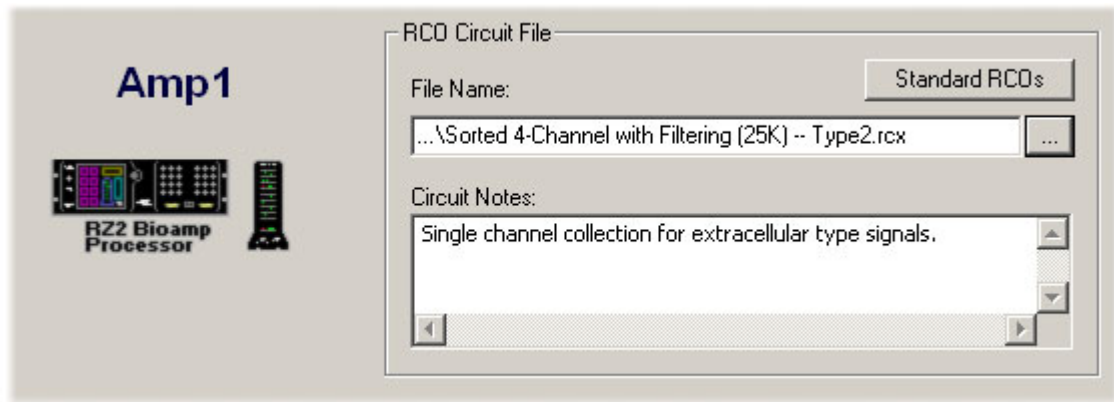

File Name

In the RCO Circuit File area, the user can type a path and file name or browse to a compiled circuit file. Clicking the Standard RCOs button or the Browse button opens a compiled circuit file Select dialog box which functions much like a standard Windows Open dialog box.

Note: You can assign a compiled circuit file using a dialog box launched from the Assign RCO command on the Device menu or by right-clicking a device and selecting Assign RCO from the shortcut menu.

Circuit Notes

Memos that are a part of the compiled circuit file can be displayed in this area. Only memos that begin with a greater than symbol (>) are displayed.

Important Notes about Selecting Compiled Circuit Files!

Because OpenEx relies on certain circuit constructs, or groupings of circuit components and parameter tags, the selected compiled circuit files must have been designed for use with OpenEx. Several Example compiled circuit files are provided so that the user can run experiments without designing their own circuits. The user must also make sure that the compiled circuit file is appropriate for the host device. For example, a compiled circuit file that includes a four channel circuit design might not be appropriate for a two channel device.

Rename Device Dialog Box

The Rename Device Dialog Box is used to rename an existing or newly assigned device.

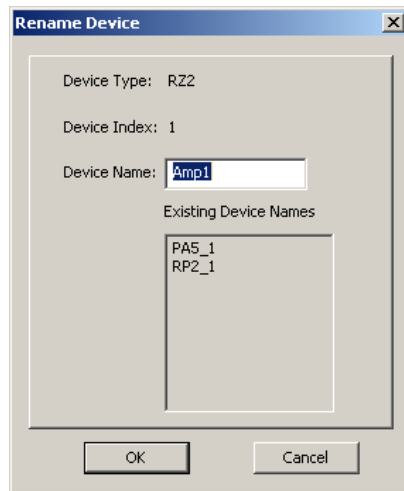

Device Type

WorkBench automatically detects the device type (part number) and lists it here. After you have named the device, you can return to the Rename Device dialog to view the device type.

Device Index

Each device in your system is given an index number according to its logical position in the system. The index number is used to differentiate between multiple devices of the same type.

Device Name

User specified text string used to identify a device in the context of an OpenEx project. This name is used in the target selection dialog in OpenController to identify devices.

Tip

Using a standard naming scheme simplifies using OpenWorkbench and OpenController. In many cases the same OpenController configuration file will work with several OpenWorkbench configuration files if the user has implemented standard naming scheme.

Many of the Device Names in the OpenEx examples follow the form:

Stim: stimulus devices

Amp1, Amp2, etc.: acquisition devices

To configure a device:

1. Select the device, by clicking its icon in the Device Navigator.
2. Click the  **Browse** button to the right of the **File Name** box.
3. Browse to the desired file (either .rco or .rcx format).
4. When you select the compiled circuit file and click Open, a Rename Device dialog box is opened. Here you can give the device a descriptive name, such as Amp or Stim. This dialog is also available from the Rename Device command on the Device menu.
5. Type a device name and click OK, to complete configuration of the device.

Storage Specification

When a compiled circuit file has been assigned to a selected device, Workbench reads the compiled circuit file and displays information about the data storage constructs in the Storage Specification table. The user can view, disable, enable, or fetch from a list of data storage circuit constructs found in the compiled circuit file that will run on the selected device. When the Workbench file is saved any user defined values are saved as part of the Workbench configuration and are used to populate the table the next time the project is loaded.

	Mode	Store ID	Tag Name	Store Description	Sampling Rate (Hz)	Num Channel
1	Store	Wave	Wave	Type-5,Cont. Waveform blocks of 2048 floats	24414.1 (25K)	32
2	Store	Tick	Tick/	Type-3,Scaler List(s) blocks of 1 floats		Single
3						
4						
5						

Mode Select Store, Disable, or Fetch from a drop-down list.

By default, all Stores are set to *Store* and are saved to the data tank. *Disable* a Store if you do not wish to view or save the corresponding data set. *Fetch* enables you to view the data in OpenController but the data is not stored and will not be available in clients, such as Scope or Explorer, that display data from the tank.

Store ID Type a user defined four character label for the Store.

This name is associated with the corresponding data in the tank and is used by other clients, such as Scope or Controller, when selecting data. By default, the tag name will be used as the Store ID. The default Store ID may be adjusted to four characters by truncation or padding with underscores (e.g. Ticker becomes Tick, PD becomes PD__).

Tip

In many cases the same OpenScope configuration file will work with several OpenWorkbench configuration files if the user has implemented standard naming scheme.

The following is an example of one possible naming scheme:

- SCAX: Scalar x(x=1,2) (Type 1, Triggered Scalar, oxScalar)
- BUFF: Buffered data (Type 2, Data Buffer, oxBuffer)
- SLTx: Scalar List (Type 3, Data List, oxList)
- CSPK: Candidate Spike (Type 4, Signal Snippet, oxSnippet)
- SSPK: Sorted Spike (Type 4, Signal Snippet, oxSnippet)
- PDEC: Plot Decimated data (Type 5, Continuous Waveform, oxStream)
- STRM: Streamed data (not decimated) (Type 5, Continuous

Waveform, oxStream)

In general, Store IDs should begin with alpha-characters, that is, letters a-z and A-Z. Store IDs must NOT begin with any of the following characters: "-", "=", "(", ")", "<", ">", "!", a space or any number 0 to 9.

The user must ensure that Store IDs are not duplicated. If data from multiple sources is stored using the same Store ID, data may be lost. This is also true of stores on multiple devices.

Tag Name	Each data Store is associated with a tag name that is used in each associated parameter tag for that data construct. This quickly identifies a group of associated parameters that will be stored to the data tank during an experiment. Note: a slash at the end of a tag name indicates that it has been set as either an (/) onset or (\) offset epoch.
Store Description	Data type and block size.
Sampling Rate	The effective sampling rate. See Setting the Sampling Rate, page 98 for more information.
Num Channel	Number of channels of data acquired by the Store.

Additional Fields

On the **Stores** menu, click **Show All Fields** to show the following columns:

Alias	Enter the name of an existing Store followed by a channel offset value to use that Store Name as an alias for the currently selected Store. The channel offset value ensures data in the aliased Store(s) is not superimposed. The Store name and offset must be separated by a comma. For example: SNIP, 16 The designated Store will be stored in the data tank using the SNIP Store ID beginning with channel 17. Caution: Before assigning a Store Alias, ensure that the data type, such as integer or float, is the same for both Stores. See Using an Alias, page 98 for more information.
Secondary Tag	Click to enable a Secondary Tag for data storage. See Secondary Tags Dialog Box, page 101 for more information.
Strobe Type	Select Not Strobe, ONset Strobe, or OFFset Strobe from a drop-down list. When ONset or OFFset Strobe is selected events are automatically indexed by TTank as they are stored creating an epoch. ONset Strobe Events are time stamped relative to the onset of the sweep. OFFset Strobe Events are time stamped relative to the offset of the sweep or condition.

See About Epoch Events, page 81 for more information.

Buddy Epoch	<p>Enter the name of the relevant buddy Store.</p> <p>The buddy epoch only needs to be set on one of the two buddy epoch rows in the Storage Specification table. The buddy epoch is typically created by declaring the Offset strobe Store as the buddy epoch in the Buddy Epoch cell in the Onset strobe Store's row.</p> <p>Buddy epochs are used to create epochs that are not continuous. See About Epoch Events, page 81 for more information.</p>
SortCode	<p>Displays whether or not a store is configured to assign sort codes. See Type 4: Signal Snippets, page 337 for more information.</p>
HandShake	<p>Indicates whether a software trigger will be used for the handshake. See Type 1: Triggered Scalar, page 330 and Type 2: Data Buffer, page 332 for more information.</p>

Using an Alias

When the Store Alias name is used to call up data in client applications, such as OpenBrowser and OpenScope, the retrieved data will include the data for the Store by that name along with the data for any Stores for which it has been selected as the Store Alias. This allows the user to call up data from several Stores, such as data from multiple devices used in multi-channel acquisition, and look at it as if it were a single data Store. The Store Alias feature enables users to access multiple Stores using a single Store name.

Caution: Before assigning a Store Alias, ensure that the data type, such as integer or float, is the same for both Stores.

Each Store can be assigned only one Store Alias. In the Store Alias box the user can enter the name of an existing Store followed by a channel offset number to assign the Store as an alias for the current Store. When the Store Alias name is used to call up data in client applications, such as OpenBrowser and OpenScope, the retrieved data will include the data for the Store by that name along with the data for any Stores for which it has been selected as the Store Alias. This allows the user to call up data from several Stores, such as data from multiple devices used in multi-channel acquisition, and look at it as if it were a single data Store.

Caution: When the Store Alias option is used a channel offset must also be used. *For example: Snip, 16.* If an offset is not provided, the data will be superimposed on the data in the Store Alias.

When a Store Alias has been assigned, the data for that Store will be saved in the tank as a part of the Store Alias, and not as the original Store name. For example, if a Store named SNP1 has been selected as the Store Alias for a Store named SNP2, the tank will only contain the SNP1 Store. SNP2 will not appear in the tank but its data will be stored with the SNP1 Store data.

Note: Aliases are assigned when data is stored to the tank. Therefore, aliases will only appear in applications that directly access the tank. Because OpenController accesses data from OpenWorkbench, data from the aliased Store does not appear with the data from the Store assigned in the Store Alias box. To view all data in OpenController use the original Store names.

Setting the Sampling Rate

The effective sample rate for each Store is displayed in the Storage Specification table when the corresponding device is selected in the Device Navigator. Sample rates for the device may be determined by the compiled circuit file or set by the user.

To display the Sampling Rate settings:

1. Select the desired device in the Device Navigator.
2. On the **Stores** menu, click **Other Options**.
3. In the Advanced Setup dialog box, click the **Sampling Rate Setup** tab.

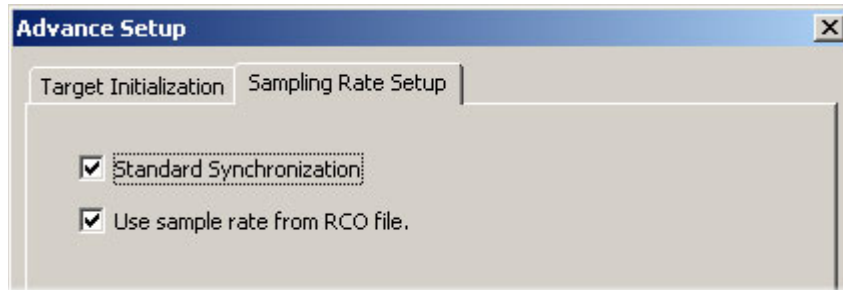
**To use the sample rate defined in the compiled circuit file:**

- Ensure the **Use sample rate from RCO file** check box is selected. This is the default setting.

Note: Compiled circuit files are interchangeable among devices, but not all devices will run all sample rates. Many compiled circuit files include the sample rate in their name.

To specify a sample rate:

1. Clear the **Use sample rate from RCO file** check box (not checked). A Bandwidth and Timing area is displayed.

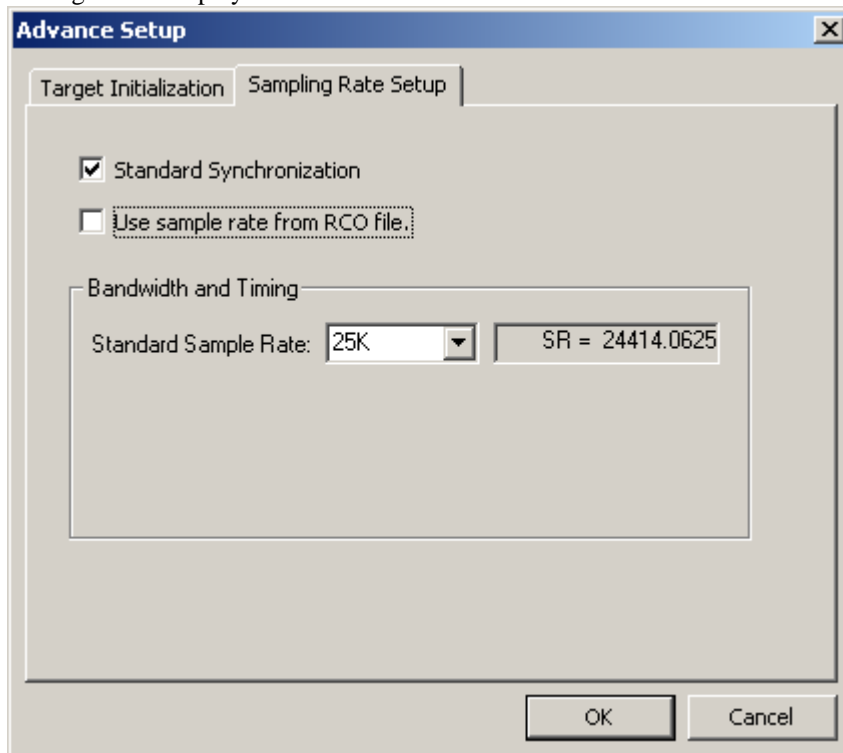

2. Select a sample rate from relevant choices for the device or, if the device allows arbitrary sample rates, enter a value in the selection box provided, then click **Check Realizable**.
3. Click **OK** to save the new settings.

Note: The *Standard Synchronization* option is not implemented at this time.

Initializing Tags - Target Initialization

In the Advance Setup dialog box the user can enter initial values for parameters controlled by parameter tags within the circuit. This allows users to predefine parameters such as the filter settings, frequency, or level of a stimulus. If a tag is not initialized it will take on the initial value of the component or parameter tag.

To display the Target Initialization settings:

1. Select the desired device in the Device Navigator.
2. On the **Stores** menu, click **Other Options**.
3. In the Advanced Setup dialog box, click the **Target Initialization** tab.

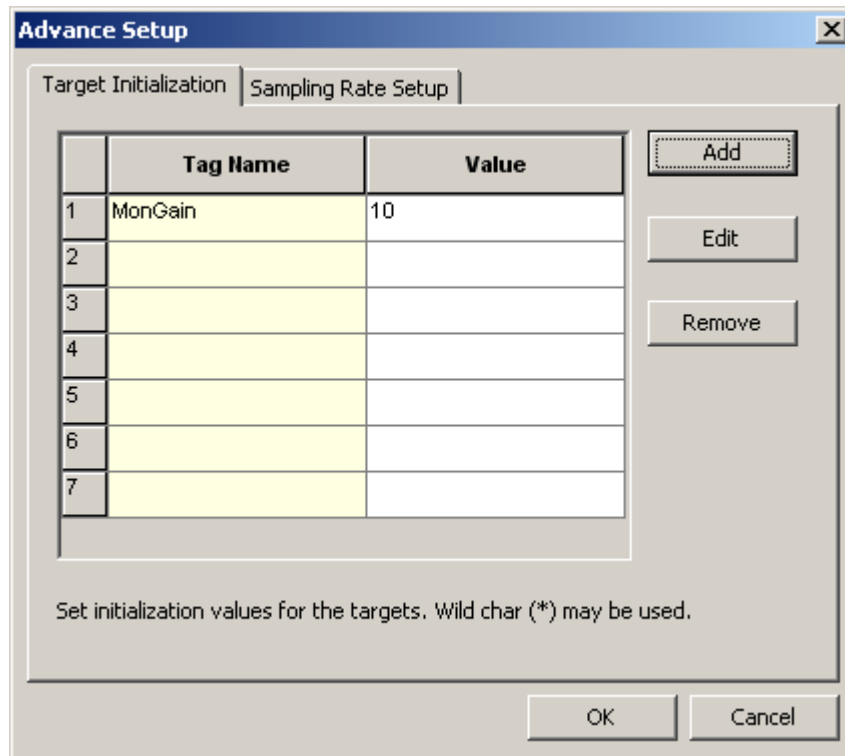

Note: Tags can also be initialized in OpenController in the Value Control Parameter Group for a modifier control.

To add a Tag Initialization Setting:

1. In the Advance Setup dialog box, click the **Add** button to the right of the list. The Tag Initialization Value dialog box is displayed.
2. Type or select a tag to initialize from the **Tag Name** drop down list.

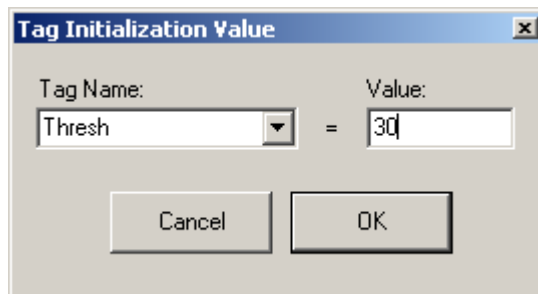

Clicking the Tag Name box displays a drop down list of all the parameter tags included in the control file assigned to the selected device.

3. In the **Value** box, type an initial value for the tag.

To edit or remove an existing value, select the desired entry and click **Edit** or **Remove**.

4. Click **OK**. The new setting will be added to the Target Initialization list.

Initializing a Series of Channels

A series of channels can be initialized using a single entry by using a number sign (#) in place of the channel number. For example: to set all tags named iChan~1, iChan~2, ... to a specific value, type **iChan~#** in the Tag Name box, and type the desired initial value in the value box to the right.

Incrementing Values

A plus sign (+) can be placed after the number sign (#), so that each successive assignment will increment the assigned value by one. For example: to set tags named iChan~1, iChan~2, iChan~3, and iChan~4 to the values 5 through 8, type **iChan~#+** in the Tag Name box, and type the value **5** in the Value box to the right.

Editing or Removing a Listed Tag

After a tag has been added to the list, the user can click the tag to enable the Edit and Remove buttons.

Edit Opens the Tag Initialization Value dialog box.

Remove Removes the selected tag from the list.

Secondary Tags Dialog Box

The Secondary Tags dialog box allows the user to add tags to the Store so that data from variables that are not associated with the circuit header can be saved. These variables share the same time stamp, are of the same data type, and have the same number of buffer points as the data identified by the circuit header.

Secondary tags can be used with Triggered Scalar (Type 1: OxScalar), Data Buffer (Type 2: OxBuffer), and Data List (Type 3: oxList) data constructs.

=== Storage Specification ===							
	Mode	Store ID	Tag Name	Alias	Store Description	Secondary Tag	Strobe Type
1	Store	Tick	Ticker		Type-1, Triggered Scalar single value	<input type="checkbox"/>	ONset Strobe
2	Store	EA__	EA		Type-4, Signal Snippet blocks of 32 floats		
3	Store	PD__	PD		Type-5, Cont. Waveform blocks of 256 shorts		
4							

To display the Secondary Targets dialog:

1. Select the desired device in the Device Navigator.

2. On the **Stores** menu, click **Show All Fields**.
3. In the Storage Specification table, click **the button in the Secondary Tag cell** for a triggered scalar, data buffer, or data list Store.



Important!: keep in mind that the secondary tag will share the same time stamp as the selected Store and must be of the same data type.

To add a tag to the Secondary Tags list:

1. In the Secondary Targets dialog, click the **Add** button to the right of the list. The Secondary Tags dialog box is displayed.

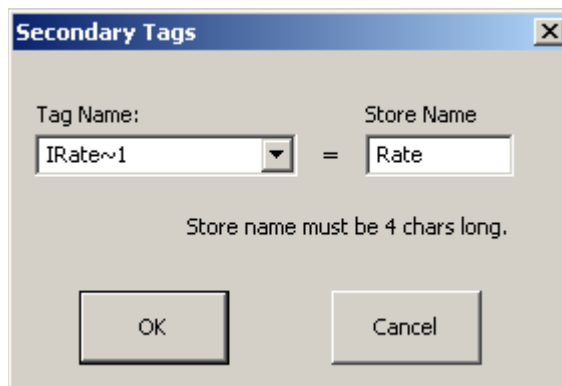

2. In the **Tag Name** box, choose, or type, a parameter tag from which secondary data is to be acquired. Clicking the Tag Name box displays a drop down list of all the parameter tags included in the compiled circuit file assigned to the selected device.
3. In the **Store Name** box, type a four character code for the specified tag. This name will be used to identify the data in the tank. It appears in the Events list of OpenScope and the Stores list of the OpenController Target Select dialog box.
4. Click **OK** to add the new tag name to the secondary targets list.

Editing or Removing a Listed Tag

After a tag has been added to the list, the user can click the tag to enable the Edit and Remove buttons.



- Edit** Opens the Secondary Data Tag dialog box
- Remove** Removes the selected tag from the list

 Secondary Tags decrease the circuit complexity by minimizing the number of circuit constructs and components required. Secondary tags are updated at the same time as the primary tags. Updating is controlled via a Latch, MultiLatch, or SerStore component.





Assigning a Data Tank

Users must choose a data tank for data storage. If a tank has not been selected, system controls are disabled and a red colored *Data Storage: Not Specified* warning is displayed in the status bar, located at the bottom of the OpenWorkbench window.

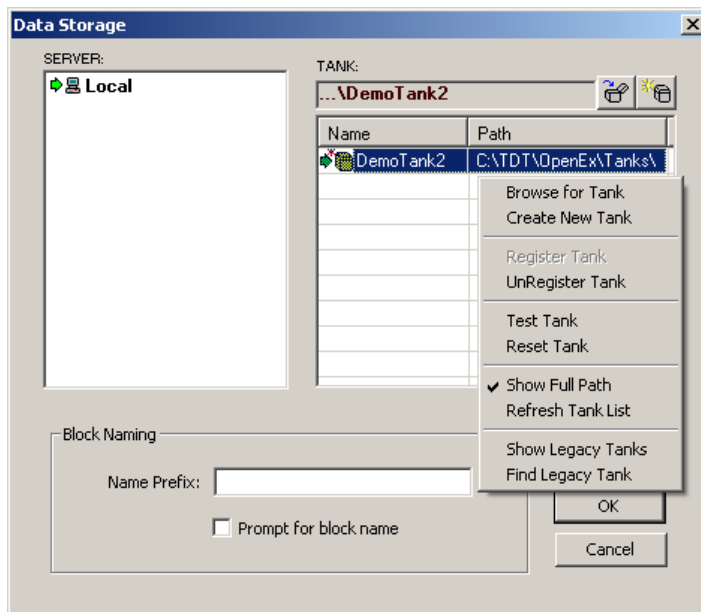
To create a new tank or assign an existing tank:

1. Click the **Data Tank** command on the **File** menu in OpenWorkbench. The Data Storage dialog box is displayed and any tanks that are registered on the selected server will appear in the list.
2. Click a **tank in the list** to select it, click the  **Create New Tank** button to create a new tank, or click the  **Browse for Tank** button to select an unregistered tank.
3. When a tank is selected, click **OK** to close the dialog box and assign the tank to the current configuration. A green arrow appears to the left of the tank name when it has been selected.



-  Registered Tank
-  Unregistered Tank
-  Registered Legacy Tank
-  Unregistered Legacy Tank

Right-clicking in the **TANK** box displays a shortcut menu with commands for creating, testing, or resetting tanks.

- Browse for Tank** Browse for folder
- Create New Tank** Opens the Select Tank file dialog box so that a tank can be added.

Register Tank	Adds the selected tank to the Windows Registry.
UnRegister tank	Removes the selected tank from the Windows Registry. The tank can still be used on the local machine.
Test Tank	Tests the connection to the server and opens and closes the tank file.
Reset Tank	Resets the selected tank file. This option returns the tank file to a state in which data can be read from or written to the tank.
Show Full Path	Toggles detail view on and off. In details view the path to the tank is displayed.
Refresh Tank List	Refreshes the Tank box display.
Show Legacy Tanks	Displays registered legacy format tanks in the tank list.
Find Legacy Tanks	Opens the Select Tank File dialog box and allows users to browse for tanks stored in the legacy format by showing files with a .tbk file extension.

Block Naming

Name Prefix

The user can enter a prefix name that will be used for each block of data stored to the selected tank. Block names consists of the prefix and a block number. For example, Block-1, Block-2...

Prompt for block name

If the user prefers to name the block when the protocol is run the Prompt for block name check box can be selected.

Server

In the **SERVER** box users can select the server where data tanks can be found or created. In many cases the server will be on the same PC that controls the hardware devices (Local).



A green arrow will appear to the left of the server name to indicate that it is selected.

Commands for common tasks such as adding, editing, and removing a server are available from a shortcut menu by right-clicking in the Server box.

Setting Up Timing and Control Protocols

Polling Rate

These settings are available from the OpenWorkbench Setup menu.

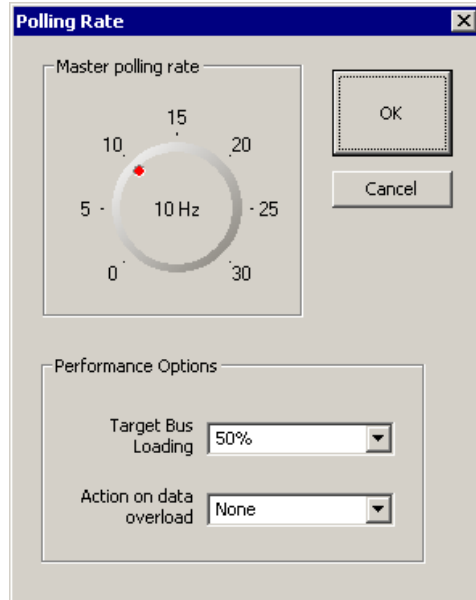

TDT recommends using OpenEx software with the Gigabit interface and setting the polling rate between 3 to 10 Hz. When using the USB interface the polling rate should be set to a low value.

The Master polling rate sets how often OpenWorkbench polls devices for new data. A high polling rate means that data is read more rapidly. However, a high polling rate decreases system efficiency.

System 3 devices circumvent one of the main problems with Windows based control of hardware. Windows does not give users precise control over when an event occurs. The System 3 devices run in real-time and circuits running on each device allow users to precisely control acquisition and presentation parameters.

To change the master polling rate: click the indicator (red dot) and drag around the arc to the desired position. The position value is displayed in the center of the knob.

Target bus loading: Specify the percentage zBus capacity to be used for transferring data from the zBus to the PC for data storage. The remaining capacity is reserved for other tasks, including serving data to OpenController. The default setting is 50% and is recommended for projects that use OpenController. If insufficient resources are available, OpenController may respond slowly or lock up.

For projects that **do not** use OpenController, such as streaming data to disk, this value can be increased to provide more resources for data storage.

Action on data overload: Specify the action taken whenever OpenWorkbench determines that the current data saving rate is overloading the system. The default setting is None.

Suspend Plotting: All storage plots in OpenWorkbench will be suspended for the duration of the overload.

Suspend Saving: suspends data storage to the tank for the duration of the overload.

Flush: flushes the current read and ensures that any data before the overflow is saved correctly to the tank.

Triggers and Mode Switching

These settings are available from the OpenWorkbench Setup menu.

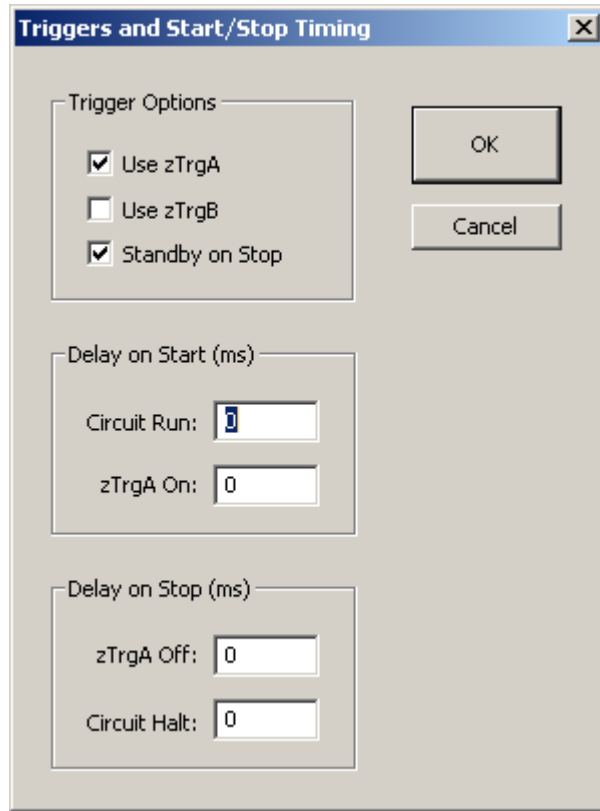

Triggering and timing circuit constructs must be included in the compiled circuit file that will be used for each device that will be enabled in the OpenWorkbench file.

Trigger Options

zBus triggers provide a trigger to racks that contain devices used and enabled in the OpenWorkbench file. There are two possible triggers and users can use one or both for triggering components. At least one trigger is required to start the experiment.

Use zTrgA

Selecting the Use zTrgA check box enables the zBusA trigger. The zBusA trigger must be present in the compiled circuit file.

Use zTrgB

Selecting the Use zTrgB check box enables the zBusB trigger. The Use zTrgB check box must be selected if the zTrgB Action on Done settings Under Sweep Loop will be used. The zBusB trigger must be present in the compiled circuit file.

Standby on Stop

The Standby on Stop check box is used in conjunction with either of the Stop when Done check boxes under Condition Loop and Sweep Loop. When the Standby on Stop check box is selected the protocol will automatically switch to Standby mode when the last condition and/or sweep loop is completed.

The use of the Standby on Stop check box requires that the corresponding sweep, condition, or nested loop control construct includes end checking. The Stop when Done check boxes under Condition Loop and Sweep Loop should never be used together.

Start/Stop Timing

The start/stop timing settings allow users to specify a time delay for starting the circuit, turning on the zBusA trigger, turning off the zBusA trigger, and halting the circuit.

Delay on Start (ms)

These settings control the time delay for starting the circuit and turning on the zBusA trigger.

Circuit Run

Specifies a time (in milliseconds) to delay before running the circuit. For example, if Circuit Run is set to 300 then, after clicking Preview or Record, OpenEx will wait 300 ms before running the circuit.

zTrgA On

Specifies a time (in milliseconds) to delay between starting the circuit and turning on the zBusA trigger. For example, if the Circuit Run delay is 300 ms and the zTrgA On delay is 500 ms, then after clicking Preview or Record, OpenEx will wait 300 ms before running the circuit, and after that another 500 ms will pass before the zBusA trigger is turned on.

Delay on Stop (ms)

These settings control the time delay for turning off the zBusA trigger and halting the circuit.

zTrgA Off

Specifies a time (in milliseconds) to delay, after OpenEx is put into Idle or Standby mode, before the zBusA trigger is turned off. For example, if zTrgA Off is set to 200 then, after clicking Idle or Standby, OpenEx will wait 200 ms before turning off the zBusA trigger.

Circuit Halt

Specifies a time (in milliseconds) to delay between turning off the zBusA trigger and halting the circuit. For example, if the zTrgA Off delay is 200 ms and the Circuit Halt delay is 600 ms, then after clicking Idle or Standby, OpenEx will wait 200 ms before turning off the zBusA trigger, and after that another 600 ms will pass before the circuit is halted.

Sweep Loop

These settings are available from the OpenWorkbench Setup menu.

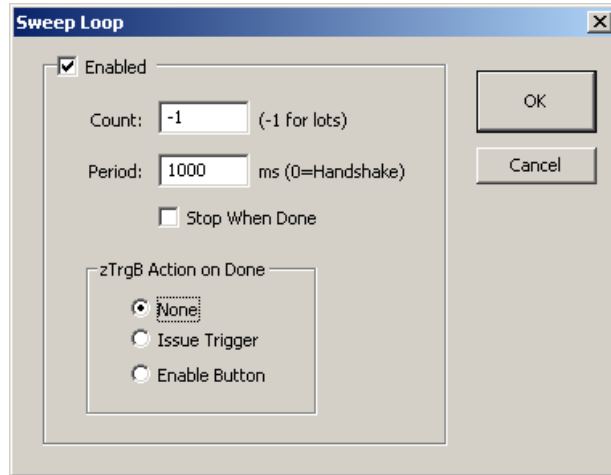

The settings under Sweep Loop can only be used if sweep control circuit constructs are included in the compiled circuit file specified for each device that will use the sweep loop.

A sweep loop controls stimulus presentation and/or acquisition. The Sweep Loop settings allow the user to control aspects of the sweep as part of a protocol. The setting under Sweep Loop can only be used if sweep control circuit constructs are included in the compiled circuit file specified for each device that will use the sweep loop.

An OpenWorkbench file may have several devices and each device might be assigned a different compiled circuit file. For example, an experiment might require stimuli to be presented at regular intervals but acquisition to be continuous. In this case, a Protocol can be set up to generate several sweeps for the stimulus presentation. The stimulus device would contain a stimulus timing protocol.

The following settings are enabled when the Sweep Loop check box is selected.

- | | |
|-----------------------|---|
| Count | Defines the number of sweeps via the zSwCount parameter tag within the compiled circuit file |
| Period | Defines the period of the sweep via the zSwPeriod parameter tag within the compiled circuit file |
| Stop When Done | Halts the experiment when all sweeps are completed (requires end checking construct)

If stop when done is not checked TTank will store data after the count has ended. This box should only be disabled if the condition is nested within a sweep. |

External Control of the Next Sweep

If an asynchronous next sweep control construct is included in the compiled circuit file, the period and count can be controlled using OpenController, an external trigger, or through a custom circuit design. Setting the Period to 0 will allow flexible control of the period. Setting the Count to -1 will allow flexible control of the count.

Control of Sweeps Nested in Conditions

Condition loops and sweep loops can be nested to generate more complex stimulus and acquisition control. When a sweep and a condition are used in the same protocol the condition triggers the sweep. How triggering occurs depends on the sweep nested in condition control construct used.

zTrgB Action on Done

If the nested sweep with end tracking construct is used, the option selected under zTrgB Action on Done will be applied at the end of the sweep cycle (indicated by the zSwDone parameter tag within the compiled circuit file).

- None** OpenWorkbench will not issue a zBusB trigger at the end of the sweep cycle
- Issue Trigger** OpenWorkbench will issue a zBusB trigger at the end of the sweep cycle.
- Enable Button** The zTrgB button in the System Control window will be available so that the user can control triggering of the next condition manually from the PC
- If timing is critical the Enable Button option should not be used. Triggering with an internal trigger line or a digital trigger will yield more precise timing.

Condition Loop

These settings are available from the OpenWorkbench Setup menu.

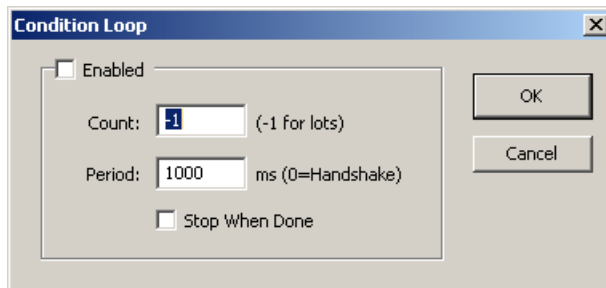

The settings under Condition Loop can be used only if condition control circuit constructs are included in the compiled circuit file to be used for each device that will use the condition loop.

A condition loop controls stimulus presentation and/or acquisition. The Condition Loop settings allow the user to control aspects of the condition as part of a protocol. The settings are enabled when the Condition Loop check box is selected.

- Count** Defines the number of sweeps via the zCdCount parameter tag within the compiled circuit file
- Period** Defines the period of the sweep via the zCdPeriod parameter tag within the compiled circuit file
- Stop When Done** Halts the experiment when all sweeps are completed (requires end checking construct)
- This box should be checked if the count is not set to -1. Otherwise data will still be stored to the tank after the Count is stopped at zero.

External Control of the Next Condition

If an asynchronous next condition control construct is included in the compiled circuit file, the period and count can be controlled using OpenController, an external trigger, or through a custom circuit design. Setting the Period to 0 will allow flexible control of the period. Setting the Count to -1 will allow flexible control of the count.

Stimulation Timing

These settings are available from the OpenWorkbench Setup menu.

Timing controls are used to control the start and duration of acquisition, stimulus presentation, and other actions. Different stimulus and acquisition timing controls provide independent control over the experimental paradigm. Before setting timing controls the sweep and/or condition controls must be enabled.

Stimulation

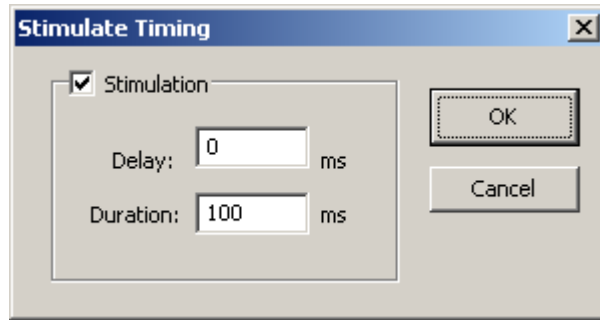

The settings under Stimulation can only be used if stimulus control circuit constructs are included in the compiled circuit file to be used for each device that will be used to present the stimulus.

The settings are enabled when the Stimulation check box is selected. When the settings are disabled the stimulus will start when the sweep fire line (SwFire within the compiled circuit file) is triggered.

- Delay** Defines the length of the delay for the start of the stimulus relative to the beginning of a condition or sweep via the zStimDelay parameter tag within the compiled circuit File
- Duration** Defines the duration of the stimulus via the zStimDur parameter tag within the compiled circuit file

Acquisition Timing

These settings are available from the OpenWorkbench Setup menu.

Timing controls are used to control the start and duration of acquisition, stimulus presentation, and other actions. Different stimulus and acquisition timing controls provide independent control over the experimental paradigm. Before setting timing controls the sweep and/or condition controls must be enabled.

Acquisition

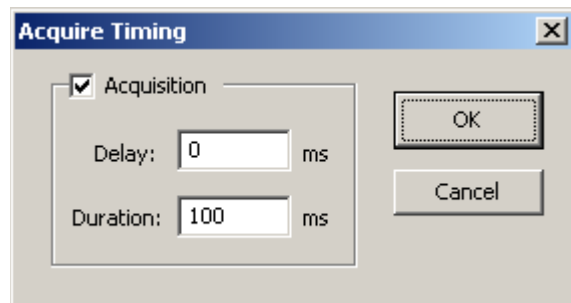

The settings under Acquisition can only be used if acquisition control circuit constructs are included in the compiled circuit file to be used for each device that will be used for acquisition.

The settings are enabled when the Acquisition check box is selected. When the settings are disabled the acquisition will start when the sweep fire line (SwFire within the compiled circuit file) is triggered.

Delay Defines the length of the delay for the start of the acquisition relative to the beginning of a condition or sweep via the zAqDelay parameter tag within the compiled circuit File

Duration Defines the duration of the acquisition via the zAqDur parameter tag within the compiled circuit file

OpenController Reference

In the OpenController Reference you will find:

A reference guide to the OpenController Workspace and the basics of adding and modifying controls.

Control Types

Step-by-step guides to creating the most common control types.

Control Settings Reference

An in-depth reference covering many of the control settings available from the Property Dialog box.

~

About OpenController

OpenController is a visual interface for designing and implementing custom control sets for OpenWorkbench experiments. During an experiment, these control sets allows users to control the status of the OpenWorkbench protocol and access acquired data and parameter variables in real-time. The OpenEx client/server architecture makes it possible for users to develop a series of control sets, each designed to modify or visualize a particular aspect of an experiment. For example, users might develop one control set to be used in an exploratory fashion (to understand the general properties of the experimental system) and a second control set to run tests that are saved for later analysis.

OpenController includes a variety of built-in controls such as gauges, switches, and plots. These controls can be added to a control set and customized by the user. The controls can be roughly grouped according to OpenController's two principal tasks.

OpenController - Two Tasks

OpenController's primary task is to allow users to control experimental parameters in real-time. Parameters, such as filter settings, threshold settings for unit activity, and stimulus presentation variables, can be modified from customizable controls within a control set. These controls, or modifiers, can send values to the system via OpenWorkbench and parameter tags within a compiled circuit file running on a Device.

OpenController's secondary task is to monitor the acquired data and parameters associated with it. Some controls read and display precise parameter values while others read and display data from OpenWorkbench Stores. These controls, or visualization tools, acquire information through OpenWorkbench and display it in OpenController according to the user's design.

How OpenController Works

OpenWorkbench generates a map of all the data in Stores and parameter tags of the devices in memory. As a client of OpenWorkbench, OpenController accesses this map to modify parameter variables and to read data for visualization. Since this map is updated in real-time (several times a second) the data displayed in OpenController is also displayed in real-time.

When OpenController modifies a parameter tag the tag is modified in this map and then updated on the device. OpenController acquires data from this map to access the variable information for data visualization.

Because OpenController is not accessing the Data Tank the 2-3 second delay associated with storing data does not occur. However, OpenController is forever in the "present" and data stored in the "past" cannot be reviewed as it can in OpenScope.

About Visualization Tools

Visualization tools are controls that allow users to visualize information that is available within the circuit running on a hardware device but is not necessarily stored in the data tank. For example, filter settings, RMS level of the signal, and the processing ability of the system can be visualized without being stored. The information from these tools can then be used to modify stimulus parameters, filter settings, and other properties of a hardware device(s).

Visualization controls also allow users to quickly see when other controls have been changed. Visualization controls can receive variable values from other controls such as sliders, switch buttons, and data tables. This allows users to quickly view the parameter changes.

OpenController includes several plots, similar to those available in Open Scope. For example, the scope/pile plot can be used to visualize data such as spike activity and streamed or decimated data. While OpenController plots are limited in functionality and can only be used to visualize the data as it is acquired, the real-time nature of these plots is a distinct advantage for real-time experimental control. OpenScope acquires data from the tank and may have a delay of up to 3 seconds between acquisition and display. In OpenController the Store information is acquired directly from OpenWorkbench so that changes in a modifier can be viewed immediately. This allows a better match between stimulus presentation and data acquisition.

About Modifiers

Modifiers are controls that can be used to control the properties of a circuit or other controls. Most often modifiers are used along with visualization controls and modifications are made in response to data visualized from one of the available plots. Modifiers can change circuit parameters that are not part of an OpenWorkbench Store, such as filter settings, thresholds for spike detection, and stimulus parameters. Modifiers can also change properties of other controls. For example, a modifier can change what data channel is displayed by a visualization control.

Parameters that may be modified using controls might or might not be saved to the tank. Parameters that are not stored in the tank, such as a threshold settings for spike detection, can be modified in real-time. Parameter variables that are stored in the tank, such as stimulus parameters, can be accessed through associated parameter tags. If the tags are also associated with an OpenWorkbench Store, the stimulus parameters are modified through the control and saved through the Store automatically.

Modifiers can also send values to other controls. For example, changing the value of a filter with a modifier such as a slider can also pass the new value to a visualization control such as a numeric display. This allows a user to monitor and modify the display properties of several controls and parameters through a single control.

Understanding Targets

A target points to the location of the data being read or the location to which a value will be written. This location might be an OpenWorkbench Store, a parameter tag within a compiled circuit file running on a device, or another control setting. Targets are defined in the properties dialog box for each control.

Types of Targets	Common Uses	Parameter Setting
Store or data buffer	Visualizing data in a plot	Data Target
Parameter tag	Visualizing data in a visualization control	Source Target
	Writing value from a modifier control	Primary Target
Control settings	Reading a value from another control	Source Target
	Writing a value to another control	Primary Target

In some controls the Alternate Target parameter can be used to write a value to multiple targets (such as parameter tags and visualization controls).

Selecting Targets

The target can be selected using the Select Target dialog box. The properties dialog box can be displayed by double-clicking the control.

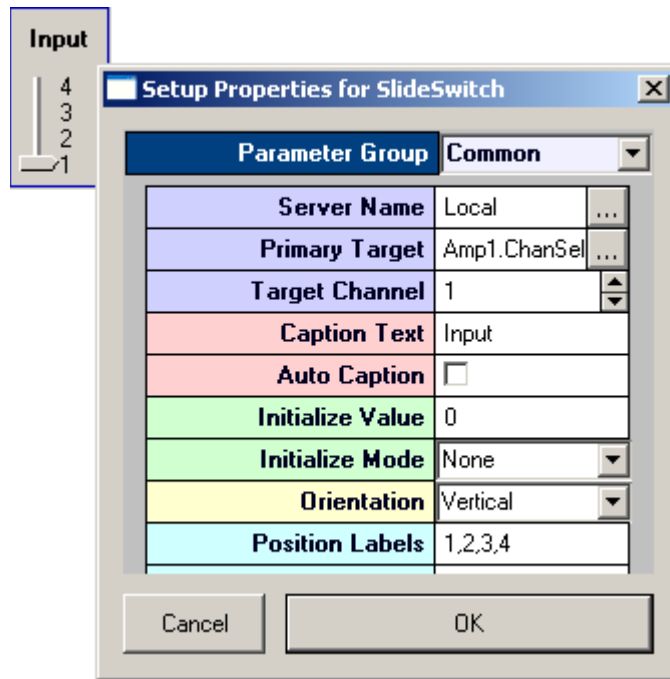

The Select Target dialog box can be opened by clicking the  button in the Source Target, Primary Target, or Alternate Target boxes in the property settings. In the Select Target dialog box, the user can browse through the hierarchy to find the target then click to select it. Finally, the selected target can be entered in the property settings by clicking OK.

Using the Master Channel Parameter

The Primary Target or Alternate Target can also be the Master Channel parameter. This special type of parameter is used to modify the Target channel parameter for a group of controls.

When used this parameter updates all controls in the same OpenController instance where the Target Channel = -1.

Controlling the Experimental Protocol

OpenController allows user to directly access the protocol modes (Record, Preview, Standby and Idle) in the OpenWorkbench System Controls. A special control called the Master Mode control can be configured to change the protocol mode when the control set is run or stopped in OpenController Run! mode.



The Master Mode control allows the user to tie OpenController's run and stop states to protocol mode settings. The run state can be configured to automatically change the protocol mode to Record, Preview, or Standby. The stop state can be configured to automatically change the protocol mode to Standby or Idle.

Using the Master Mode control to control the experimental protocol from an OpenController control set allows the user greater flexibility during an experiment. For example, the Stop state could be linked to Standby mode. In Standby mode the protocol continues to run but no data is stored to the tank. The Run state could be linked to Record mode so that when adjustments to the control settings are complete and the control is run, recording will resume.

If multiple OpenController clients are open the OpenWorkbench protocol status can be updated from any client or OpenWorkbench. This ensures that the most recently applied settings are always in effect.

Master Mode Control Settings

In the Common parameters group there are drop-down menus for Mode on Run and Mode on Stop. These settings allow the user to choose which protocol mode will be selected when the control set is run or stopped.

Mode on Run

None: The Master Mode control does not change the status of the OpenWorkbench protocol on run. Use this if you want another control or OpenWorkbench to determine when to record data.

Standby: The status of the OpenWorkbench protocol is set to Standby on run. In standby mode the circuit will load and run and controls can modify and read data from parameter tags but not from the OpenWorkbench Stores.

Preview: The status of the OpenWorkbench protocol is set to Preview on run. In Preview mode users can visualize data from Stores; however, the Store data is not saved to the tank. Use this mode to look at the data before running through an experimental protocol.

Record: The status of the OpenWorkbench protocol is set to Record on run. In Record mode data is saved to the tank.

Mode on Stop

None: The Master Mode control does not change the status of the OpenWorkbench protocol on stop. Use this if you want another control or OpenWorkbench to control the protocol.

Standby: The status of the OpenWorkbench protocol is set to Standby on stop. This allows the circuit to continue running without storing data. This is useful to make sure that the proper settings are defined before stimulus presentation or data acquisition occurs.

Idle: The status of the OpenWorkbench protocol is set to Idle on stop. This halts the processing chain on the devices.

Note: Use caution when setting Mode on Stop to Idle. In Idle mode many values set from OpenController are cleared from the hardware. Use Standby mode, rather than Idle, to use Stop to pause an experiment.

Using Multiple Control Sets

Because multiple control clients can access and modify the OpenWorkbench map of the hardware devices it is possible that two clients might attempt to access the same device parameter. This can lead to corruption of the memory map or unreliable data. The user must make sure that only one OpenController client at a time accesses each parameter variable. For example, two clients which include a control with the potential to modify the same parameter might be open, but only one would be active. Using the Master Mode Control in conjunction with window property settings for the Run and Stop buttons give the user the ability to accomplish this.

Workspace Basics

About the OpenController Workspace

The OpenController workspace includes a main grid or display area where multiple controls can be added and arranged into a customized control set. The OpenController workspace includes two modes: Design mode and Run! mode. Users can toggle between modes using a Toggle Mode button on the toolbar.



In Design mode users can add, configure, and modify controls.

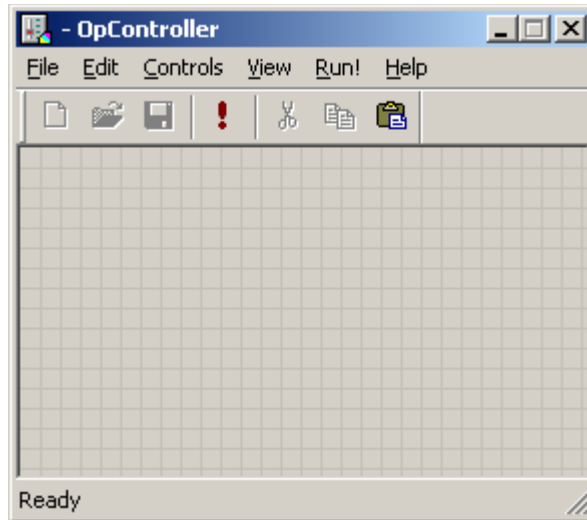

In Run! mode users can use controls for real-time monitoring and control of an ongoing experiment.

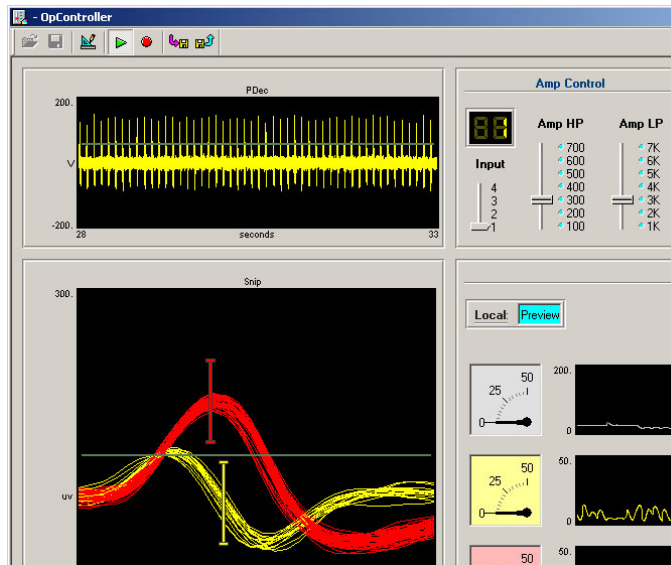

A menu bar is available in Design mode and toolbars are also provided in both modes for easy access to commands.

Using Design Mode

Design mode allows users to add and customize groups of controls that will function together in a single OpenController configuration file. A menu bar, toolbar, and shortcut menus are available for easy access to commands.

In Design mode the main window is a grid area where controls can be added, sized, and organized to create a control set. Controls can be added from the Control menu.

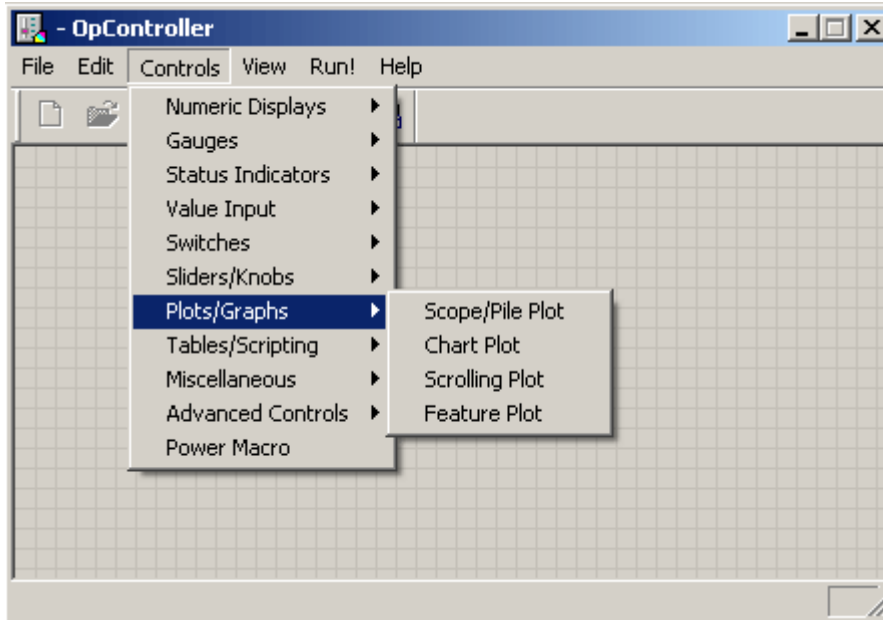

Once added, controls can be manipulated similarly to many Windows objects. Users can drag a control to move it or drag a control's border to resize it.

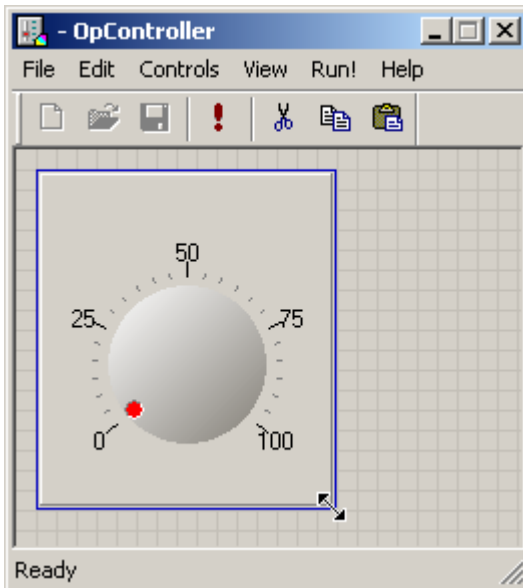

Using Properties Dialog Boxes

The appearance and behavior of each control can be modified using the properties dialog box. The properties dialog box contains all of the customizable settings for a selected control.

To open the properties dialog box for a control, double-click the control in the grid area of OpenController's Design mode.

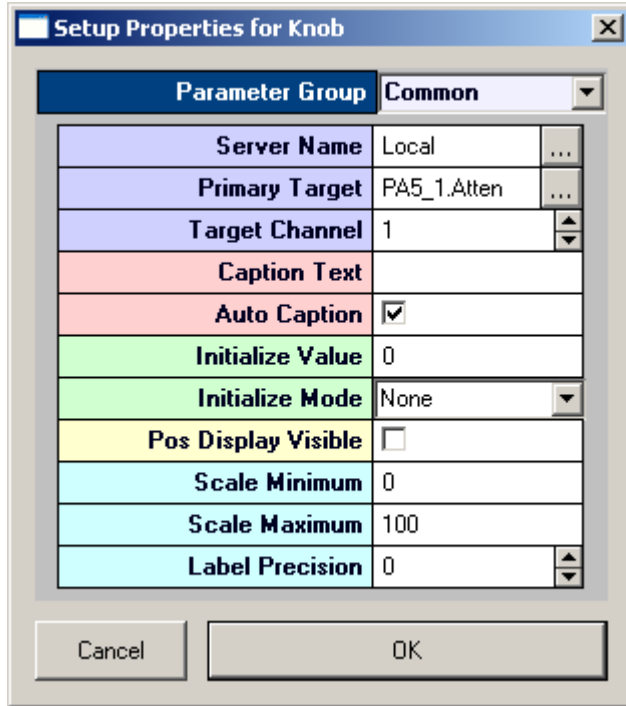

While all properties dialog boxes look and behave in a similar fashion, the settings available depend upon the control being modified.

Control settings are grouped into parameter groups. The properties dialog box opens with the most commonly used settings for the selected control displayed. To display the settings available in another group, click the Parameter Group value box at the top of the dialog box and select the group from the list.

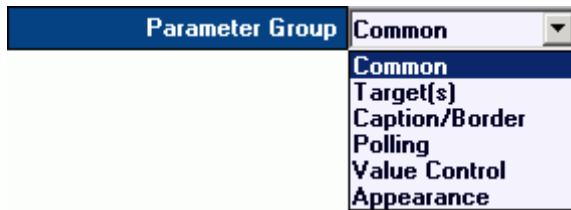

Target Settings

When settings, such as Source Target, must be set using the name of a target a Lookup button  is located to the right of the value box. Clicking the Lookup button opens the Select Target dialog box.

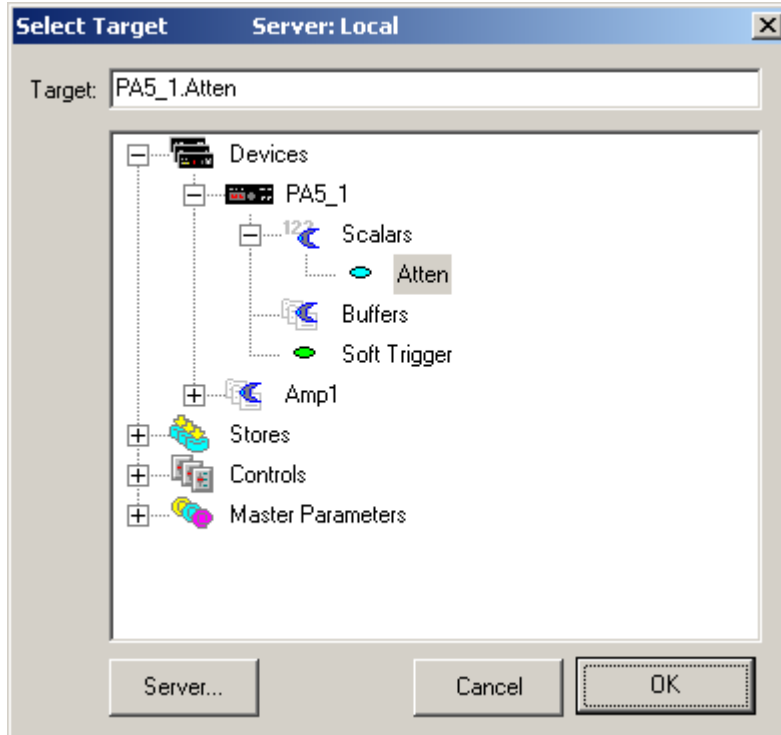

In the Select Target dialog box, a list of available targets in the current OpenWorkbench experiment is displayed.



Using the Select Target Dialog Box

Possible targets are displayed in an expandable hierarchy. Potential targets are grouped into the four types: devices, stores, controls and master parameters. Each level of the hierarchy can be collapsed or expanded by clicking the expand (+) or collapse (-) symbol to the left of the level.

Devices

Under devices, possible targets are grouped by device and are further divided into scalars or buffers. The data type of a target is indicated by the color of the target's icon. **The user must select a target of an appropriate type for the data that will be read.** Target names for targets found under a Device in the hierarchy include the device name (much like a path to the target). If devices are named sequentially (such as: Amp1, Amp2, Amp3) users can select the same target across multiple devices by modifying the target name to replace the number found in the last position of a device name with an asterisk (*) (such as: Amp*.HPfreq).

Scalars

	float	Blue
	integer	Teal
	logic (i.e. 0,1)	Green

 **Buffers**

-  data pink
-  coefficients purple





Chan **Channel Number**

Scalars and buffers that are followed by a tilde (~) include multiple channels. The user can expand them to show and select the channels. Users can select the multi-channel target (such as sEA~) rather than a single channel in some cases (such as using multi-view plots).



Note: coefficients are typically used in spike sorting and filter coefficients.





 **Stores**

The Store type corresponds to the data construct type and is indicated by its icon.

-  Scalar Type 1: Triggered Scalar
-  Buffer Type 2: Data Buffer
-  List Type 3: Data List
-  Snippet Type 4: Signal Snippets
-  Stream Type 5: Continuous Waveform



 **Controls**

Under controls the possible targets are grouped first by control name , then by the setting group . Control names correspond to the value in the My Name setting and the groups correspond to the parameter groups in the property setting dialog box for that control. The value type for a setting is indicated by its icon. **The user must select a target of an appropriate type for the data that will be read.**

-  whole number
-  integer number
-  check box
-  Color
-  drop down list

Master Parameters

Under Master Parameters there are three standard targets: master channel, master sort code, and master device. These targets allow the user to update key groups of parameter tags with a single control.

	master channel	Note: updates all controls in the same OpenController instance where the Target Channel = -1 . Appears as @Channel in the target parameter in the parameters dialog box.
	master sort code	Not Implemented
	master device	Not Implemented

Using Run! Mode

Run! mode initializes the control client application (OpenController) and allows it to access the memory map of the hardware generated in OpenWorkbench. Because several control sets can be open at a time, it is important to ensure that only one or two are accessing the OpenWorkbench memory map. When multiple OpenController windows modify the same parameters, such as stimulus frequencies, the OpenWorkbench memory map can become corrupted. For each parameter tag only one modifier control should be active and running.

Note: this does not apply to visualization controls.

In Run! mode the control set can have several states. Understanding and using these states correctly can help the user avoid memory map corruption.

Running and active:

By default, controls are loaded and active when the user places OpenController in Run! mode. The state of the OpenController configuration can then be controlled using the Run and Stop buttons on the toolbar. When the controls are running and active the frames around each control's borders are gray.

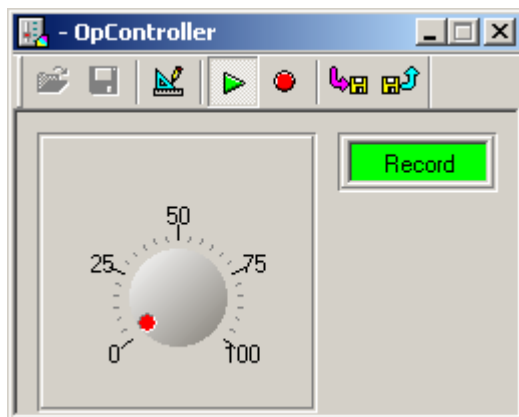

Control set is running and
OpenWorkbench protocol is running.

When the OpenWorkbench protocol is in Standby mode, the controls will appear to be running and active (gray borders) but data is not read and updated. This may result in blank plot screens in the running and active state.

Running with one or more controls inactive:

When the corresponding OpenWorkbench file is not open or its status is idle, the targets will not be found and a yellow border appears around the control. In the following example, the target for the SSPK plot can not be found because the OpenWorkbench protocol is set to Idle.

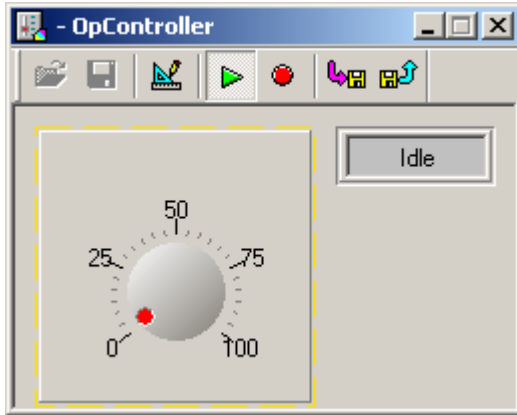

Control set is running and OpenWorkbench protocol is at Idle.

The yellow border might also indicate that the wrong OpenWorkbench file is opened or that a target was identified incorrectly in the control's property settings.

Stopped but active:

An active device can modify the OpenWorkbench memory map but does not acquire data from the memory map. If the controls are modified this will modify whatever parameter tag or control property they are linked to. However, the visualization tools are halted. The example below shows this state.

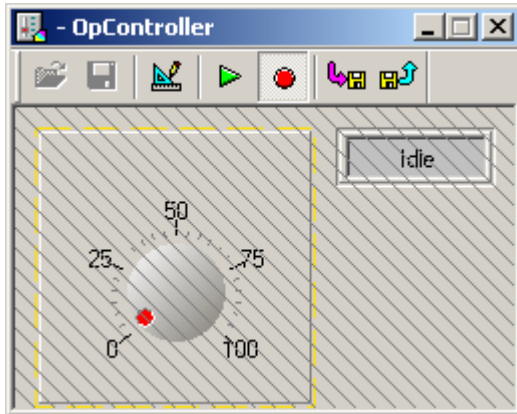

Control set is stopped but active and OpenWorkbench protocol is at Idle.

Stopped and locked:

In the stopped and locked state the controls are inactive. A hatched line is placed through the controls. In this case the controls can not modify any other devices. To set up a control so that it locks when stopped go double-click on the grid and select the Behavior parameter group in the properties dialog box, then select Lock on Stop.

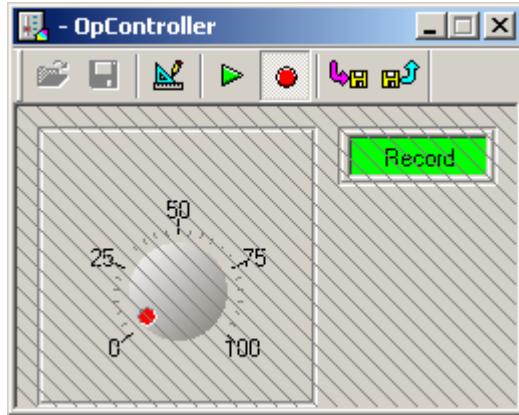

Control set is stopped and locked,
OpenWorkbench protocol is at Record.

Saving and Loading your Settings

OpenController uses a save and load state feature which allows you to retain settings such as slider switch positions, sort parameters, and more. Configuring automatic or manual save/load states can be done using OpenController's Setup Default Properties dialog box.

To open the Setup Default Properties dialog box:

- Double-click the **empty grid area** of OpenController's Design mode.

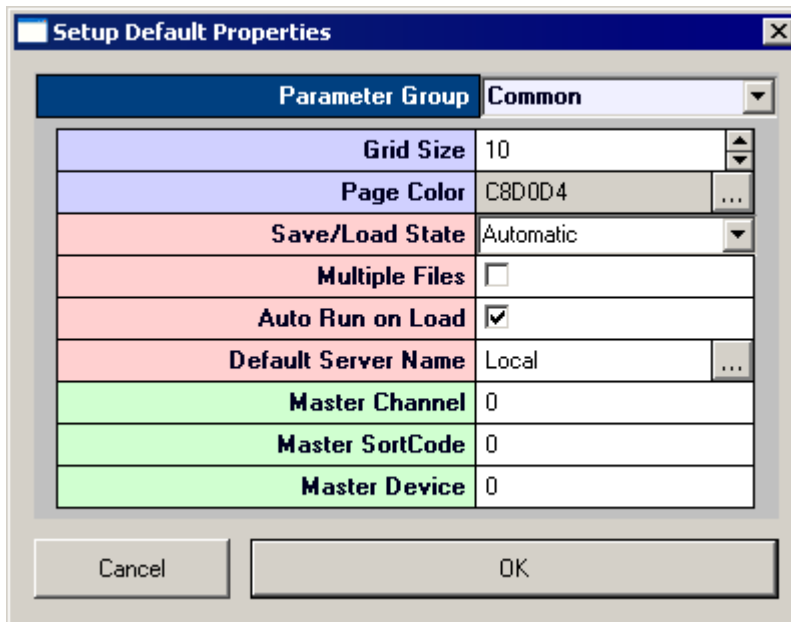

Two settings are available for saving and loading state behavior in the Setup Default Properties dialog box:

Save/Load State
Multiple Files.

Save/Load State

The Save/Load state setting determines whether or not the controller state will be saved automatically or manually. OpenController uses controller state data files (*.csf) to store and load settings.

Automatic

With this setting, automatic saving and loading is performed by OpenController. All the settings in OpenController are automatically saved when a project is halted (Idle mode) or closed. Settings

are also saved if OpenController is put into stop or design mode. When the project is opened and run again, or if OpenController is put into Run! mode, the settings are automatically loaded.

When operating in the automatic setting, OpenController will append the status **Save/Load Auto** to the project's controller title bar when the default save state is saved or loaded.



The **NO FILE LOADED** status is also appended if a save state has not yet been loaded.



While in Run! mode, OpenController will automatically save and load controller settings.

If the Multiple Files setting (below) is enabled, controller will prompt you to save to a specified *.csf file whenever you change from run to design mode and will also prompt you to specify a *.csf file to load whenever you change from design to run mode. With this setting active, the currently loaded save state file name will be appended to the title bar.



Manual

With the Manual setting, saving and loading is performed using the save and load state buttons while in Run! Mode.



Saves the current control parameter settings to the default controller state data file.



Loads the last saved control parameter settings from the default controller state data file.

When operating in the manual setting, OpenController will append the status **Save/Load Manual** to the project's controller title bar when the default save state is saved or loaded.

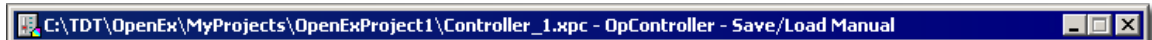

The **NO FILE LOADED** status is also appended if a save state has not yet been loaded.



If the Multiple Files setting (below) is enabled, controller will prompt you to specify a *.csf file whenever you save or load the controller state. With this setting active, the currently loaded save state file name will be appended to the title bar.

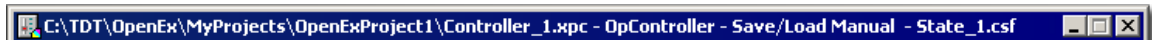

Multiple Files

The Multiple Files setting allows multiple controller states to be saved, each in a separate controller state data file (*.csf). Saving multiple files allow different states to be saved for different experimental subjects or conditions.

By default, all controller state data files are located in the **UserFiles** directory of your project folder. When the Multiple Files setting is disabled, OpenController will automatically create a *.csf file named after the OpenController instance in OpenProject (the default name is Controller_1).

Control Types

Control Types and the Controls Menu

Controls can be added from the Controls menu and are logically grouped on this menu. The controls below are organized using the Controls menu groupings.

Group	Control Type
Numeric Displays	Value Watch 7 Segment Display
Gauges	Linear Gauge Logarithmic Gauge
Status Indicators	Led Indicator Led Caption
Value Input	Input Box
Switches	Switch Button Slide Switch
Sliders/Knobs	Knob Slider
Plots/Graphs	Scope/Pile Plot Chart Plot Scrolling Plot Feature Plot
Tables/Scripting	Data Table VBScript
Miscellaneous	Graphic Frame
Advanced Controls	Master Mode Control SigGen Engine Biquad Coefficient Generator Snippet Sort Control Scrolling Threshold Control

Visualization Tools

About Gauges

A gauge displays real-time changes to a variable. Gauges provide an excellent way to determine if parameter properties are within the experimental bounds. For example, a gauge could show spike activity (spikes per second), RMS (root mean square) noise on a channel, or the calibrated intensity of a stimulus. The advantage of using a gauge rather than a digital display is that the gauge can be color coded to indicate when the parameter is within a reasonable zone. During an experiment the precise value may be less important than whether it is below or above a certain value.

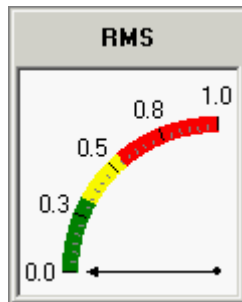

In this example, the control is configured to show the RMS (Root Mean Square) noise of the acquisition channel along with color coding to indicate when the RMS level has become too high. Green indicates good, yellow indicates caution or watch, and red indicates that the noise level is too high.

Linear Gauge

Before using a gauge the user should determine what variable is to be measured. This variable must either be a Store or have a parameter tag associated with it.

OpenController includes both linear and logarithmic gauges. The user should select the appropriate gauge depending on the type of data to be visualized. Both types of gauges are created in a similar way.

Creating a Linear Gauge

To quickly create a linear gauge:

1. Click the **Controls** menu, point to **Gauges**, and click **Linear Gauge**.

The pointer changes to indicate that the control can be added.

2. Click the grid to position the upper-left corner of the control.

The control is added to the grid area.

3. Double-click the control to display the **properties dialog** box.

The dialog box opens with the most commonly changed settings displayed. Related settings are grouped together by color. Other settings are available by clicking the **Parameter Group** box and selecting a **settings group**.

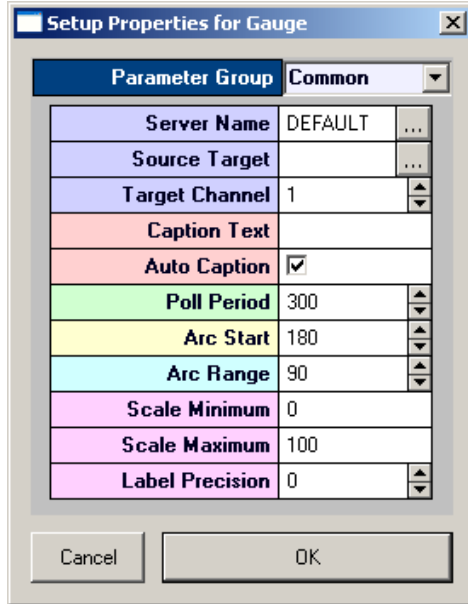

Settings groups include:

Common - pg. 206
 Target(s) - pg. 220
 Caption/Border - pg. 189
 Polling - pg. 216
 Value Control - pg. 220
 Layout - pg. 215
 Scale - pg. 217
 Pointer - pg. 192
 Sections - pg. 193

4. If needed, type the server name and path in the **Server Name** box.
 If the data is being stored on the same computer where OpenController is running, the default setting is fine. The server name can be found in the **Data Tank/Data Storage** dialog box in OpenWorkbench.
5. Click the **...** button in the Source Target box, to display the **Select Target** dialog box.
6. Using the **Select Target** dialog browse for and select a target.
7. If the source target is a Store with multiple channels, enter the channel number in the **Target Channel** box.
8. In the **Scale Minimum** box, enter the minimum value for gauge values that will be displayed.
9. In the **Scale Maximum** box, enter the maximum value for gauge values that will be displayed.
10. Click **OK**.

A basic linear gauge is created. Before running the control the corresponding OpenWorkbench file must be open and a protocol should be running. To run the control, click **Run!** on the menu bar.

Creating a Logarithmic Gauge

To quickly create a logarithmic gauge:

1. Click the **Controls** menu, point to **Gauges**, and click **Logarithmic Gauge**.
 The pointer changes to indicate that the control can be added.
2. Click the grid to position the upper-left corner of the control.
 The control is added to the grid area.
3. Double-click the control to display the **properties dialog** box.
 The dialog box opens with the most commonly changed settings displayed. Related settings are grouped together by color. Other settings are available by clicking the **Parameter Group** box and selecting a **settings group**.

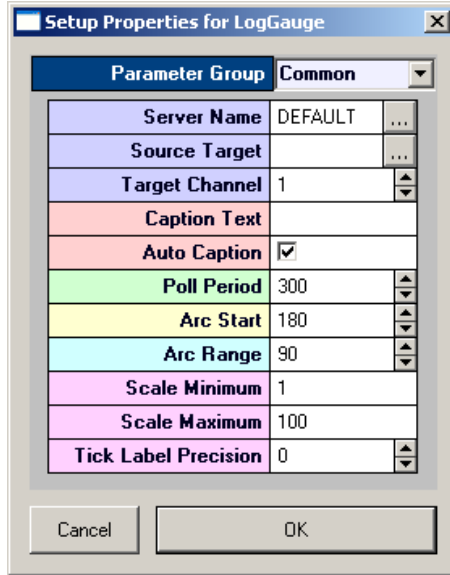

Settings groups include:

- Common - pg. 206
- Target(s) - pg. 220
- Caption/Border - pg. 189
- Polling - pg. 216
- Value Control - pg. 220
- Layout - pg. 215
- Scale - pg. 217
- Pointer - pg. 192
- Sections - pg. 193

4. If needed, type the server name and path in the **Server Name** box.
If the data is being stored on the same computer where OpenController is running, the default setting is fine. The server name can be found in the **Data Tank/Data Storage** dialog box in OpenWorkbench.
5. Click the **...** button in the Source Target box, to display the **Select Target** dialog box.
6. Using the **Select Target** dialog browse for and select a target.
7. If the source target is a Store with multiple channels, enter the channel number in the **Target Channel** box.
8. In the **Scale Minimum** box, enter the minimum value for gauge values that will be displayed.
9. In the **Scale Maximum** box, enter the maximum value for gauge values that will be displayed.
10. Click **OK**.

A basic logarithmic gauge is created. Before running the control the corresponding OpenWorkbench file must be open and a protocol should be running. To run the control, click **Run!** on the menu bar.

About Numeric Displays

Numeric displays show a precise variable value. A common use of a display would be to show the filter settings of the signal input, the exact threshold setting for a discriminator, or the sweep number of the stimulus.

Before using a numeric display the user should determine what variable is to be measured. This variable must either be an OpenWorkbench Store or have a parameter tag associated with it.

There are two types of numeric displays, the Value Watch and the 7 Segment Display.



7 Segment Display

Value Watch

Both displays work similarly and vary mostly in appearance. The 7 Segment Display is styled to appear similar to a typical LCD numeric display. There are also two small but perhaps more significant differences. The Value Watch allows unit text to be added to the display by the user. The 7 segment display allows the display of a positive or negative sign.

Creating a 7 Segment Display

To quickly create a 7 segment display:

1. Click the **Controls** menu, point to **Numeric Displays**, and click **7 Segment Display**.
The pointer changes to indicate that the control can be added.
2. Click the grid to position the upper-left corner of the control.
The control is added to the grid area.
3. Double-click the control to display the **properties dialog** box.

The dialog box opens with the most commonly changed settings displayed. Related settings are grouped together by color. Other settings are available by clicking the **Parameter Group** box and selecting a **settings group**.

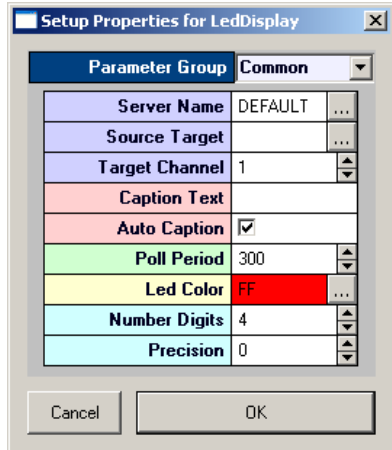

Settings groups include:

- Common - pg. 200
- Target(s) - pg. 220
- Caption/Border - pg. 189
- Polling - pg. 216
- Value Control - pg. 220
- Appearance - pg. 194
- Layout - pg. 214

4. If needed, type the server name and path in the **Server Name** box.
If the data is being stored on the same computer where OpenController is running, the default setting is fine. The server name can be found in the **Data Tank/Data Storage** dialog box in OpenWorkbench.
5. Click the **...** button in the **Source Target** box, to display the **Select Target** dialog box.
6. Using the **Select Target** dialog browse for and select a target.
7. If the source target is a Store with multiple channels, enter the channel number in the **Target Channel** box.
8. Enter the number of digits to be displayed in the **Number Digits** box.

By default, the leading unused digits will be displayed as spaces. The total number of digits should be sufficient to display the desired precision.

9. Enter the number of digits to be displayed after the decimal point in the **Precision** box.
10. Click **OK**.

A basic 7 segment display is created. Before running the control the corresponding OpenWorkbench file must be open and a protocol should be running. To run the control, click **Run!** on the menu bar.

Creating a Value Watch

To quickly create a value watch:

1. Click the **Controls** menu, point to **Numeric Displays**, and click **Value Watch**.
The pointer changes to indicate that the control can be added.
2. Click the grid to position the upper-left corner of the control.
The control is added to the grid area.
3. Double-click the control to display the **properties dialog** box.

The dialog box opens with the most commonly changed settings displayed. Related settings are grouped together by color. Other settings are available by clicking the **Parameter Group** box and selecting a **settings group**.

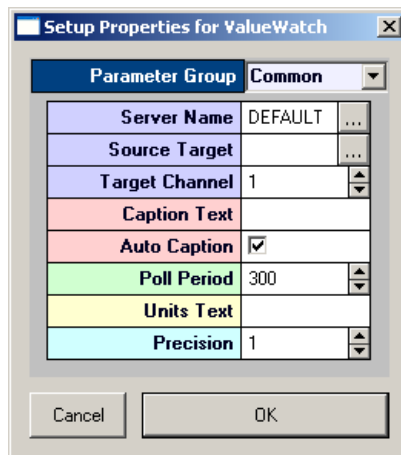

Settings groups include:

- Common - pg. 213
- Target(s) - pg. 220
- Caption/Border - pg. 189
- Polling - pg. 216
- Value Control - pg. 220
- Appearance - pg. 197

4. If needed, type the server name and path in the **Server Name** box.
If the data is being stored on the same computer where OpenController is running, the default setting is fine. The server name can be found in the **Data Tank/Data Storage** dialog box in OpenWorkbench.
5. Click the **...** button in the **Source Target** box, to display the **Select Target** dialog box.
6. Using the **Select Target** dialog browse for and select a target.
7. If the source target is a Store with multiple channels, enter the channel number in the **Target Channel** box.
8. Enter the number of digits to be displayed after the decimal point in the **Precision** box.
9. Click **OK**.

A basic value watch is created. Before running the control the corresponding OpenWorkbench file must be open and a protocol should be running. To run the control, click **Run!** on the menu bar.

About Status Indicators

Status indicators can be used to indicate when the level of a signal is greater than a certain value. These indicators flash when the value change exceeds an On/Off threshold set by the user. Similar to a gauge, the status indicator allows users to identify a potentially important issue. For example, the indicator can be set to flash if the processing power of the system exceeds a certain level.

There are two types of indicators, the Led Indicator and the Led Caption.



Led Indicator

Led Caption

The led indicator resembles a typical round LED light with a text caption to the side. With a led caption, the caption text is part of the flashing display.

Creating a Led Indicator

To quickly create a led indicator:

1. Click the **Controls** menu, point to **Status Indicators**, and click **Led Indicator**.

The pointer changes to indicate that the control can be added.

2. Click the grid to position the upper-left corner of the control.

The control is added to the grid area.

3. Double-click the control to display the **properties dialog** box.

The dialog box opens with the most commonly changed settings displayed. Related settings are grouped together by color. Other settings are available by clicking the **Parameter Group** box and selecting a **settings group**.

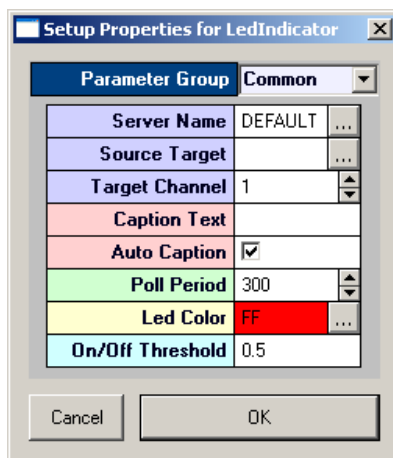

Settings groups include:

Common - pg. 205
 Target(s) - pg. 220
 Caption/Border - pg. 189
 Polling - pg. 216
 Value Control - pg. 220
 Appearance - pg. 195

4. If needed, type the server name and path in the **Server Name** box.

If the data is being stored on the same computer where OpenController is running, the default setting is fine. The server name can be found in the **Data Tank/Data Storage** dialog box in OpenWorkbench.

5. Click the **...** button in the **Source Target** box, to display the **Select Target** dialog box.

6. Using the **Select Target** dialog browse for and select a target.
7. In the **On/Off Threshold** box, type the threshold. If the value change is greater than the threshold, the indicator will be toggled off or on.
8. Click **OK**.

A basic led indicator is created. Before running the control the corresponding OpenWorkbench file must be open and a protocol should be running. To run the control, click **Run!** on the menu bar.

Creating a Led Caption

To quickly create a led caption:

1. Click the **Controls** menu, point to **Status Indicators**, and click **Led Caption**.

The pointer changes to indicate that the control can be added.

2. Click the grid to position the upper-left corner of the control.

The control is added to the grid area.

3. Double-click the control to display the **properties dialog** box.

The dialog box opens with the most commonly changed settings displayed. Related settings are grouped together by color. Other settings are available by clicking the **Parameter Group** box and selecting a **settings group**.

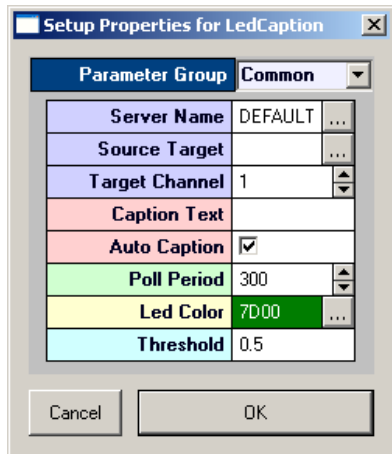

Settings groups include:

- Common - pg. 204
- Target(s) - pg. 220
- Caption/Border - pg. 189
- Polling - pg. 216
- Value Control - pg. 220
- Appearance - pg. 195

4. If needed, type the server name and path in the **Server Name** box.
If the data is being stored on the same computer where OpenController is running, the default setting is fine. The server name can be found in the **Data Tank/Data Storage** dialog box in OpenWorkbench.
5. Click the **...** button in the **Source Target** box, to display the **Select Target** dialog box.
6. Using the **Select Target** dialog browse for and select a target.
7. In the **Threshold** box, type the threshold. If the value change is greater than the threshold, the indicator will be toggled off or on.
8. Click **OK**.

A basic led caption control is created. Before running the control the corresponding OpenWorkbench file must be open and a protocol should be running. To run the control, click **Run!** on the menu bar.

Plots and Graphs

About Plots and Graphs

OpenController plots and graphs are used to visualize data in real-time. Plots and graphs differ from other controls in that the Source Target must be an OpenWorkbench Store. Plots and graphs can be used in conjunction with controls that modify parameters so that changes in the data that might result from modifying a parameter, such as a filter or threshold settings, can be viewed with out delays. There are four standard types of plots and graphs available in OpenController: Scope/Pile, Chart, Scrolling, and Feature.

Scope and Pile Plots

The Scope/Pile plot acts like a triggered oscilloscope. When an event such as a set time trigger or epoch event occurs the waveform data is displayed in the graph. If the waveform is small (<100 points) the values can be plotted on top of each other (pile) so that a quick comparison can be done. The user can set the depth of the pile. For very large waveforms (>100 points) setting the pile depth to one displays a single continuous waveform.

Chart Plot

The Chart plot displays time stamped values. The data streams across the graph either continuously or synced to an external event. The chart plot is excellent for viewing the distribution of time stamped events such as wave snippets, epoch events (Data Lists), or buffered signals. It can be expanded and contracted to show a larger or smaller times.

Scrolling Plot

The Scrolling Plot is similar to a chart recorder. The waveform streams across the plot window from left to right. This is an excellent tool for visualizing continuous signals such as EEG waveforms or the plot decimated signals of an extracellular recording.

Feature Plot

The Feature Plot measures two signal properties of a snippet waveform and displays them as a scatter plot. This tool is excellent for data mining of multiple unit activity. The feature plot can display comparisons of waveform features such as total amplitude, peak amplitudes, the area under the curve, and peak-to-peak time differences.

Creating a Pile Plot

To quickly create a single channel pile plot:

1. Click the **Controls** menu, point to **Plots/Graphs**, and click **Scope/Pile Plot**.
The pointer changes to indicate that the control can be added.
2. Click the grid to position the upper-left corner of the control.
The control is added to the grid area.
3. Double-click the control to display the **properties dialog** box.

The dialog box opens with the most commonly changed settings displayed. Related settings are grouped together by color. Other settings are available by clicking the **Parameter Group** box and selecting a **settings group**.

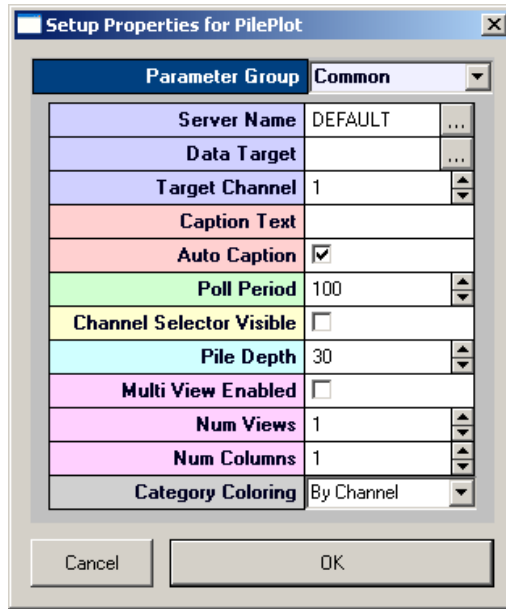

Settings groups include:

- Common - pg. 208
- Target(s) - pg. 219
- Caption/Border - pg. 189
- Polling - pg. 216
- Value Control - pg. 220
- Data/Source Set - pg. 190
- Behavior - pg. 198
- Channel Selector - pg. 190
- Multi View - pg. 191
- Colors - pg. 190
- Refresh Control - pg. 192
- Scaling - pg. 192
- X-Axis Setup - pg. 193
- Y-Axis Setup - pg. 194
- Appearance - pg. 195
- Margins - pg. 191
- Filtering - pg. 191

4. If needed, type the server name and path in the **Server Name** box.
If the data is being stored on the same computer where OpenController is running, the default setting is fine. The server name can be found in the **Data Tank/Data Storage** dialog box in OpenWorkbench.
5. Click the **...** button in the **Data Target** box, to display the **Select Target** dialog box.
6. Using the **Select Target** dialog browse for and select a target.
The source target should be an OpenWorkbench Store. To create a pile plot the source target should be a signal snippet.

 **Tip:** look for this icon to identify snippets in the **Select Target** dialog box.

7. Enter the desired channel in the **Target Channel** box.
8. If the data includes a sort code (uses the Sort Spike component) select the **By SortCode** color-coding method in the **Category Coloring** box.
9. Click **OK**.

A basic pile plot is created. Before running the control the corresponding OpenWorkbench file must be open and a protocol should be running. To run the control, click **Run!** on the menu bar.

At this point a plot of the spikes will appear and the pile plot will look something like this:

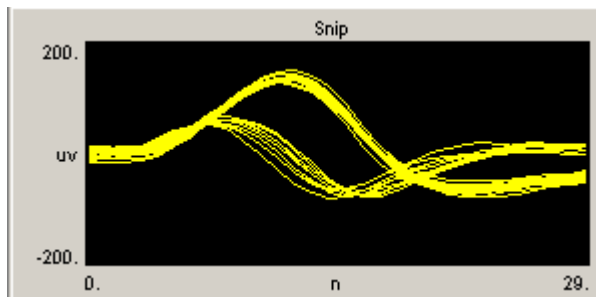

Common Modifications

Multi View

If the Store has multiple channels, select the Multi View Enabled check box then enter the number of channels in the Num Views box. The example below enables the Multi View and selects the number of channels (3) for visualization.

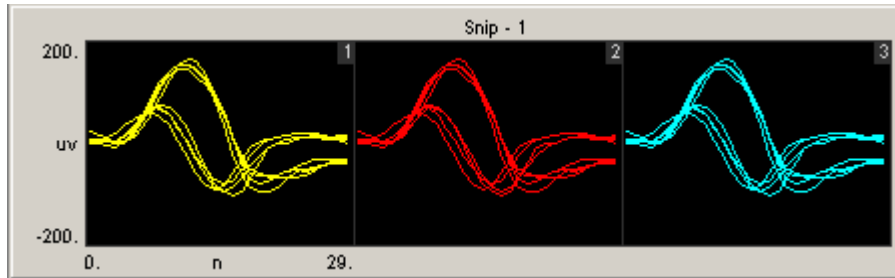

Scope Plot

The Scope/Pile Plot control can also be configured to behave as a Scope plot.

Creating a Scope Plot

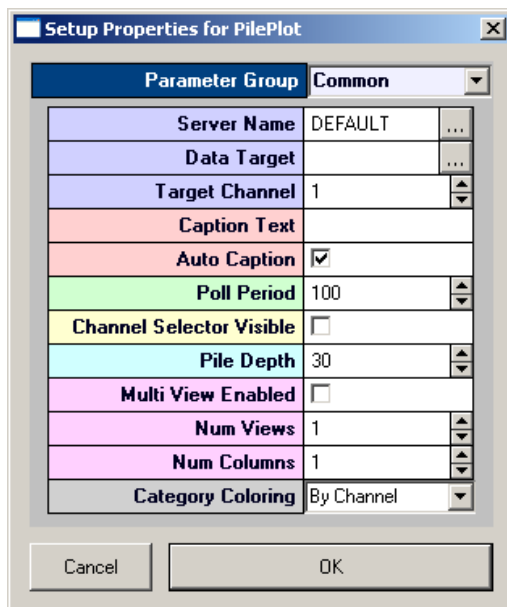

To quickly create a single channel scope plot:

1. Click the **Controls** menu, point to **Plots/Graphs**, and click **Scope/Pile Plot**.
The pointer changes to indicate that the control can be added.
2. Click the grid to position the upper-left corner of the control.
The control is added to the grid area.
3. Double-click the control to display the **properties dialog** box.
The dialog box opens with the most commonly changed settings displayed. Related settings are grouped together by color. Other settings are available by clicking the **Parameter Group** box and selecting a **settings group**.



Settings groups include:

Common - pg. 208
 Target(s) - pg. 219
 Caption/Border - pg. 189
 Polling - pg. 216
 Value Control - pg. 220
 Data/Source Set - pg. 190
 Behavior - pg. 198
 Channel Selector - pg. 190
 Multi View - pg. 191
 Colors - pg. 190
 Refresh Control - pg. 192
 Scaling - pg. 192
 X-Axis Setup - pg. 193
 Y-Axis Setup - pg. 194
 Appearance - pg. 195
 Margins - pg. 191
 Filtering - pg. 191

4. If needed, type the server name and path in the **Server Name** box.
 If the data is being stored on the same computer where OpenController is running, the default setting is fine. The server name can be found in the **Data Tank/Data Storage** dialog box in OpenWorkbench.
5. Click the  button in the **Data Target** box, to display the **Select Target** dialog box.
6. Using the **Select Target** dialog browse for and select a target.
 The source target should be an OpenWorkbench Store. To create a scope plot a continuous data type should be selected.
 **Tip:** look for this icon to identify continuous waveform in the **Select Target** dialog box.
7. Enter the desired channel in the **Target Channel** box.
8. Set the **Pile Depth** to **1**. This will cause the screen to update on each block.
9. Click **OK**.

A basic scope plot is created. Before running the control the corresponding OpenWorkbench file must be open and a protocol should be running. To run the control, click **Run!** on the menu bar.

At this point the plot will look something like this:

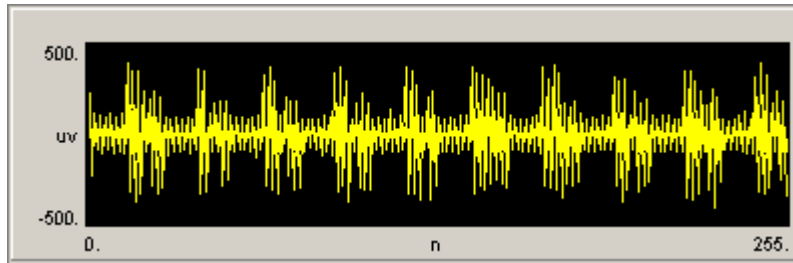

The plot length or number of points is set in the compiled circuit file by the data construct. Changing the amount of data viewed requires changing the block size in the oxStream component.

Creating a Chart Plot

To quickly create a single chart plot:

1. Click the **Controls** menu, point to **Plots/Graphs**, and click **Chart Plot**.

The pointer changes to indicate that the control can be added.

2. Click the grid to position the upper-left corner of the control.

The control is added to the grid area.

3. Double-click the control to display the **properties dialog** box.

The dialog box opens with the most commonly changed settings displayed. Related settings are grouped together by color. Other settings are available by clicking the **Parameter Group** box and selecting a **settings group**.

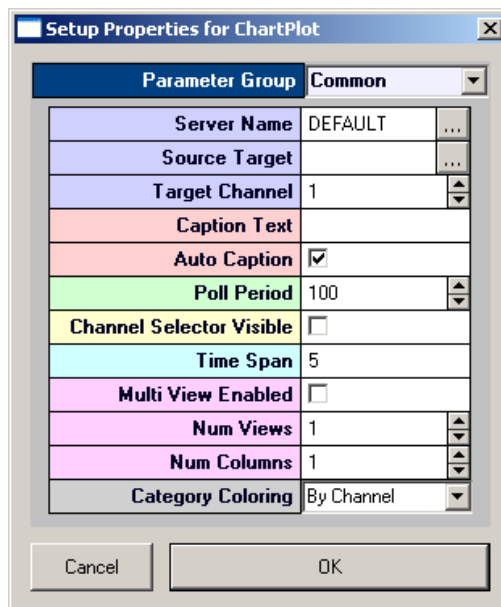

Settings groups include:

Common - pg. 201
 Target(s) - pg. 219
 Caption/Border - pg. 189
 Polling - pg. 216
 Value Control - pg. 220
 Data/Source Set - pg. 190
 Behavior - pg. 197
 Channel Selector - pg. 190
 Multi View - pg. 191
 Colors - pg. 190
 Refresh Control - pg. 192
 Scaling - pg. 192
 X-Axis Setup - pg. 193
 Y-Axis Setup - pg. 194
 Appearance - pg. 195
 Margins - pg. 191

4. If needed, type the server name and path in the **Server Name** box.

If the data is being stored on the same computer where OpenController is running, the default setting is fine. The server name can be found in the **Data Tank/Data Storage** dialog box in OpenWorkbench.

5. Click the  button in the **Source Target** box, to display the **Select Target** dialog box.
6. Using the **Select Target** dialog browse for and select a target.

The source target should be an OpenWorkbench Store. Chart plots are often used to view snippets.



Tip: look for this icon to identify snippets in the **Select Target** dialog box.

7. If the source target is a Store with multiple channels, enter the channel number in the **Target Channel** box.
8. Click **OK**.

A basic chart plot is created. Before running the control, the corresponding OpenWorkbench file must be open and a protocol should be running. To run the control, click **Run!** on the menu bar.

Creating a Scrolling Plot

To quickly create a scrolling channel plot:

1. Click the **Controls** menu, point to **Plots/Graphs**, and click **Scrolling Plot**.

The pointer changes to indicate that the control can be added.

2. Click the grid to position the upper-left corner of the control.

The control is added to the grid area.

3. Double-click the control to display the **properties dialog** box.

The dialog box opens with the most commonly changed settings displayed. Related settings are grouped together by color. Other settings are available by clicking the **Parameter Group** box and selecting a **settings group**.

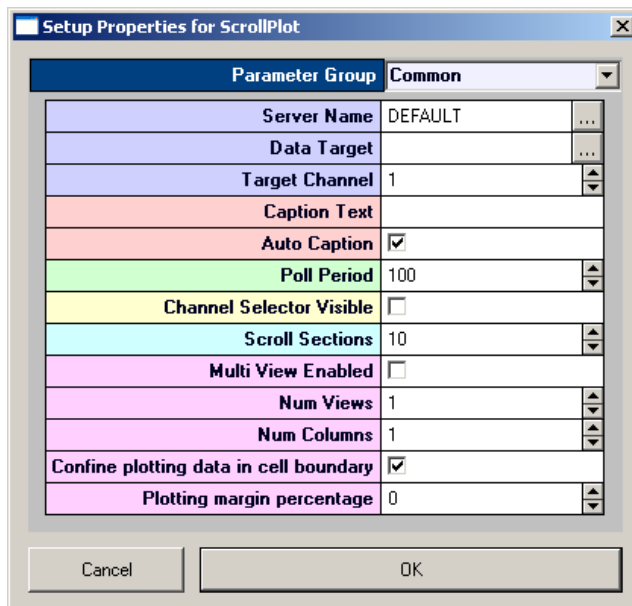

Settings groups include:

- Common - pg. 209
- Target(s) - pg. 219
- Caption/Border - pg. 189
- Polling - pg. 216
- Value Control - pg. 220
- Data/Source Set - pg. 190
- Behavior - pg. 198
- Channel Selector - pg. 190
- Multi View - pg. 191
- Refresh Control - pg. 192
- Scaling - pg. 192
- X-Axis Setup - pg. 193
- Y-Axis Setup - pg. 194
- Appearance - pg. 195
- Margins - pg. 191

4. If needed, type the server name and path in the **Server Name** box.

If the data is being stored on the same computer where OpenController is running, the default setting is fine. The server name can be found in the **Data Tank/Data Storage** dialog box in OpenWorkbench.

5. Click the  button in the **Data Target** box, to display the **Select Target** dialog box.
6. Using the **Select Target** dialog browse for and select a target.

The source target should be an OpenWorkbench Store. Scrolling plots are most commonly used with continuous waveforms.

 **Tip:** look for this icon to identify continuous waveform in the **Select Target** dialog box.

7. Enter the desired channel in the **Target Channel** box.
8. Click **OK**.

A scrolling plot is created. Before running the control, the corresponding OpenWorkbench file must be open and a protocol should be running. To run the control, click **Run!** on the menu bar.

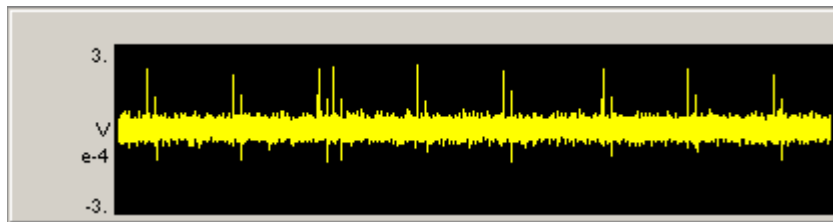

Creating a Feature Plot

A feature plot is used to display two waveform properties and is an excellent tool for separating waveforms. Waveforms that are different will be in separate parts of the feature space. Feature space plots use snippet Stores (Type 4, Signal Snippet) or possibly buffer Stores (Type 2, Data Buffer) to display differences.

The data Store should contain less than 100 samples per waveform. Waveforms that are too large will increase the processing time and slow down the system.

1. Click the **Controls** menu, point to **Plots/Graphs**, and click **Feature Plot**.
The pointer changes to indicate that the control can be added.
2. Click the grid to position the upper-left corner of the control.
The control is added to the grid area.
3. Double-click the control to display the **properties dialog** box.
The dialog box opens with the most commonly changed settings displayed. Related settings are grouped together by color. Other settings are available by clicking the **Parameter Group** box and selecting a **settings group**.

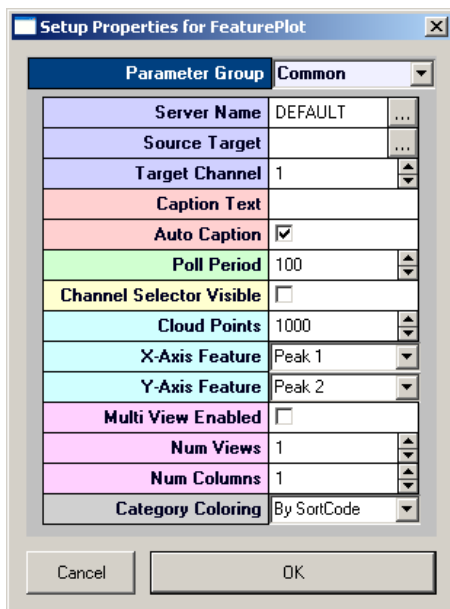

Settings groups include:

Common - pg. 202
 Target(s) - pg. 219
 Caption/Border - pg. 189
 Polling - pg. 216
 Value Control - pg. 220
 Data/Source Set - pg. 190
 Behavior - pg. 197
 Channel Selector - pg. 190
 Multi View - pg. 191
 Colors - pg. 190
 Refresh Control - pg. 192
 Scaling - pg. 192
 X-Axis Setup - pg. 193
 Y-Axis Setup - pg. 194
 Appearance - pg. 195
 Margins - pg. 191
 Filtering - pg. 191

4. If needed, type the server name and path in the **Server Name** box.
 If the data is being stored on the same computer where OpenController is running, the default setting is fine. The server name can be found in the **Data Tank/Data Storage** dialog box in OpenWorkbench.
5. Click the **...** button in the **Source Target** box, to display the **Select Target** dialog box.
6. Using the **Select Target** dialog browse for and select a target.
 The source target should be an OpenWorkbench Store.
7. Enter the desired channel in the **Target Channel** box.
8. Set the **Cloud Points** to **100**. This will cause the screen to display the 100 most recent points.
9. Set the **X-axis feature** (**Total Amplitude, Peak 1, Peak 2, Peak to Peak Time, or Area**)
10. Set the **Y-axis feature** (**Total Amplitude, Peak 1, Peak 2, Peak to Peak Time, or Area**)
11. Select the **Category Coloring**, either **by SortCode** or **by Channel**.
12. Click **OK**.

A feature plot is created. Before running the control, the corresponding OpenWorkbench file must be open and a protocol should be running. To run the control, click **Run!** on the menu bar.

In the example below a sort spike plot generates sort codes based on a time-amplitude windows. The feature space of the two plots based on peak 1 and peak 2 is displayed on the feature plot on the right.

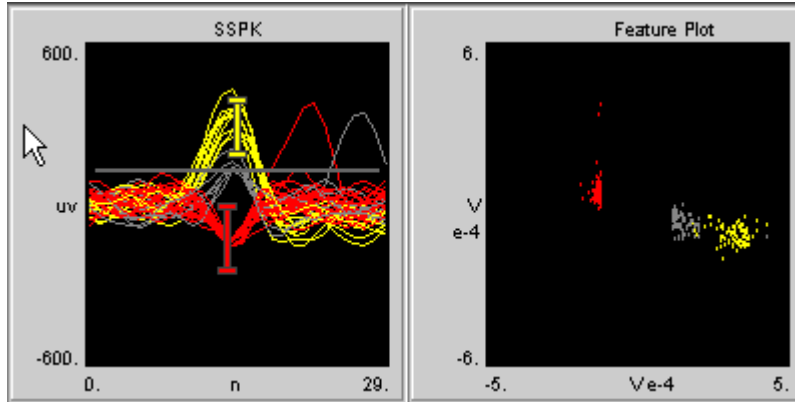

Modifiers

About Value Inputs

Value inputs are used to modify a variable. In the input box, users input the variable and press the send arrow to change the value of a parameter tag. Value inputs can be used to set filter values, a single frequency or intensity value that will change, or a number such as the number of sweeps between stimuli.



Input Box

Creating an Input Box

To quickly create an input box:

1. Click the **Controls** menu, point to **Value Input**, and click **Input Box**.
The pointer changes to indicate that the control can be added.
2. Click the grid to position the upper-left corner of the control.
The control is added to the grid area.
3. Double-click the control to display the **properties dialog** box.
The dialog box opens with the most commonly changed settings displayed. Related settings are grouped together by color. Other settings are available by clicking the **Parameter Group** box and selecting a **settings group**.

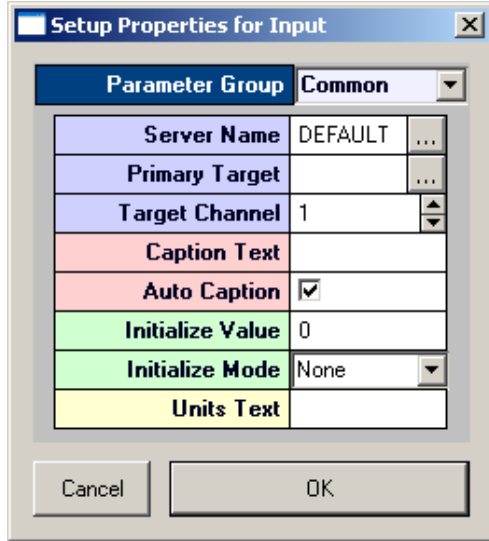

Settings groups include:

- Common - pg. 203
- Target(s) - pg. 219
- Caption/Border - pg. 189
- Polling - pg. 216
- Value Control - pg. 220
- Appearance - pg. 194
- Behavior - pg. 198

4. If needed, type the server name and path in the **Server Name** box.
If the data is being stored on the same computer where OpenController is running, the default setting is fine. The server name can be found in the **Data Tank/Data Storage** dialog box in OpenWorkbench.
5. Click the **...** button in the **Primary Target** box, to display the **Select Target** dialog box.
6. Using the **Select Target** dialog browse for and select a target.
7. Click **OK**.

A basic value input is created. Before running the control the corresponding OpenWorkbench file must be open and a protocol should be running. To run the control, click **Run!** on the menu bar.

About Switches

Switches are used to toggle a variable between user specified values. There are three types of switches, the Switch Slider, the Switch Button and the Momentary Button. Users click a button or drag a slider to toggle the value sent to a parameter tag.

The Switch button and Momentary button have two values while the slider button can have multiple values. Clicking a Switch button toggles between the two values. Clicking a Momentary button turns the control on for a user specified length of time.

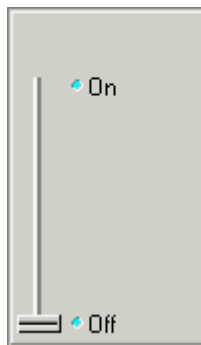

Slide Switch



Switch/Momentary Button

Creating a Switch Button

To quickly create a switch button:

1. Click the **Controls** menu, point to **Switches**, and click **Switch Button**.

The pointer changes to indicate that the control can be added.

2. Click the grid to position the upper-left corner of the control.

The control is added to the grid area.

3. Double-click the control to display the **properties dialog** box.

The dialog box opens with the most commonly changed settings displayed. Related settings are grouped together by color. Other settings are available by clicking the **Parameter Group** box and selecting a **settings group**.

Parameter Group		Common
Server Name	DEFAULT	...
Primary Target		...
Target Channel	1	▲▼
Caption Text		
Auto Caption	<input checked="" type="checkbox"/>	
Initialize Value	0	
Initialize Mode	None	▼
Button Text	Push Me!	
Value when On	1	
Value when Off	0	

Settings groups include:

Common - pg. 212

Target(s) - pg. 219

Caption/Border - pg. 189

Polling - pg. 216

Value Control - pg. 220

Appearance - pg. 196

Behavior - pg. 200

4. If needed, type the server name and path in the **Server Name** box.
If the data is being stored on the same computer where OpenController is running, the default setting is fine. The server name can be found in the **Data Tank/Data Storage** dialog box in OpenWorkbench.
5. Click the **...** button in the **Primary Target** box, to display the **Select Target** dialog box.
6. Using the **Select Target** dialog browse for and select a target.
7. In the **Button Text** box, type text to be displayed on the button.
8. In the **Value when On** box, specify a value for when the switch is on.
9. In the **Value when Off** box, specify a value for when the switch is off.
10. Click **OK**.

A basic switch button is created. Before running the control the corresponding OpenWorkbench file must be open and a protocol should be running. To run the control, click **Run!** on the menu bar.

Creating a Momentary Button

To quickly create a momentary button:

1. Click the **Controls** menu, point to **Switches**, and click **Momentary Button**.
The pointer changes to indicate that the control can be added.
2. Click the grid to position the upper-left corner of the control.
The control is added to the grid area.
3. Double-click the control to display the **properties dialog** box.

The dialog box opens with the most commonly changed settings displayed. Related settings are grouped together by color. Other settings are available by clicking the **Parameter Group** box and selecting a **settings group**.

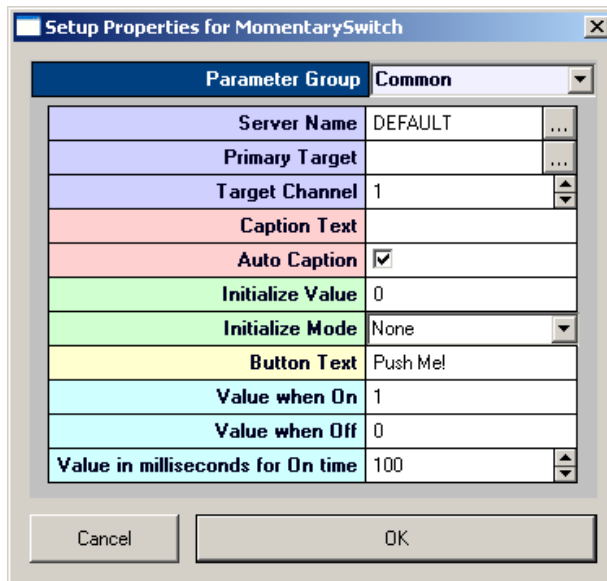

Settings groups include:

Common - pg. 207
 Target(s) - pg. 219
 Caption/Border - pg. 189
 Polling - pg. 216
 Value Control - pg. 220
 Appearance - pg. 196
 Behavior - pg. 198

4. If needed, type the server name and path in the **Server Name** box.
If the data is being stored on the same computer where OpenController is running, the default setting is fine. The server name can be found in the **Data Tank/Data Storage** dialog box in OpenWorkbench.
5. Click the **...** button in the **Primary Target** box, to display the **Select Target** dialog box.
6. Using the **Select Target** dialog browse for and select a target.
7. In the **Button Text** box, type text to be displayed on the button.
8. In the **Value when On** box, specify a value for when the button is on.
9. In the **Value when Off** box, specify a value for when the button is off.
10. Click **OK**.

A momentary switch button is created. Before running the control the corresponding OpenWorkbench file must be open and a protocol should be running. To run the control, click **Run!** on the menu bar.

Creating a Slide Switch

To quickly create a Slide Switch:

1. Click the **Controls** menu, point to **Switches**, and click **Slide Switch**.
The pointer changes to indicate that the control can be added.
2. Click the grid to position the upper-left corner of the control.
The control is added to the grid area.
3. Double-click the control to display the **properties dialog** box.

The dialog box opens with the most commonly changed settings displayed. Related settings are grouped together by color. Other settings are available by clicking the **Parameter Group** box and selecting a **settings group**.

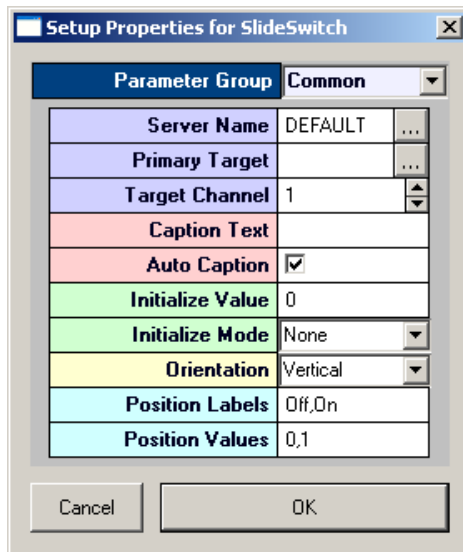

Settings groups include:

- Common - pg. 211
- Target(s) - pg. 219
- Caption/Border - pg. 189
- Polling - pg. 216
- Value Control - pg. 220
- Appearance - pg. 196
- Layout - pg. 215
- Switch Position - pg. 193

4. If needed, type the server name and path in the **Server Name** box.

If the data is being stored on the same computer where OpenController is running, the default setting is fine. The server name can be found in the **Data Tank/Data Storage** dialog box in OpenWorkbench.

5. Click the **Primary Target** box, to display the **Select Target** dialog box.
6. Using the **Select Target** dialog browse for and select a target.
7. Enter the desired values in the **Position Labels** box.
Labels are separated by a comma and are used as points for selecting labels.
8. Enter the desired values in the **Position Values** box.
Values are separated by a comma and are used as points for selecting values.
9. Click **OK**.

A basic slide switch is created. Before running the control the corresponding OpenWorkbench file must be open and a protocol should be running. To run the control, click **Run!** on the menu bar.

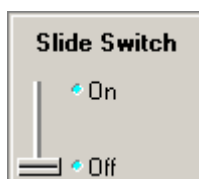

About Sliders and Knobs

Sliders and knobs are used to modify a variable. Users input the variable value by dragging a slider or turning a knob. This allows the user to select a value from a range of values and to determine the desired value by making small adjustments. Sliders and knobs can be used to set values such as frequencies or intensities. Sliders and knobs vary primarily in appearance.

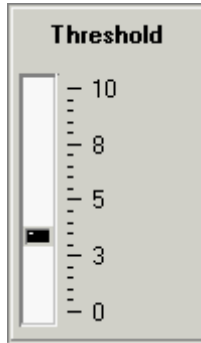

Slider

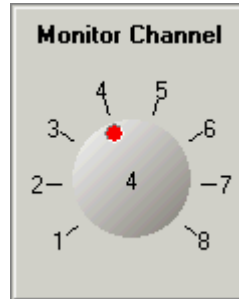

Knob

Creating a Slider

To quickly create a slider:

1. Click the **Controls** menu, point to **Sliders/Knobs**, and click **Slider**.
The pointer changes to indicate that the control can be added.
2. Click the grid to position the upper-left corner of the control.
The control is added to the grid area.
3. Double-click the control to display the **properties dialog** box.

The dialog box opens with the most commonly changed settings displayed. Related settings are grouped together by color. Other settings are available by clicking the **Parameter Group** box and selecting a **settings group**.

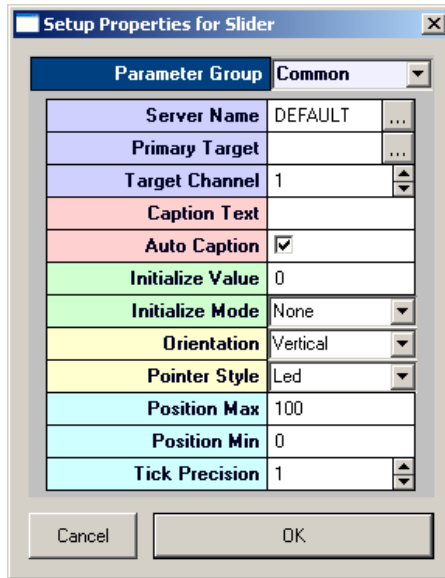

Settings groups include:

Common - pg. 210
 Target(s) - pg. 219
 Caption/Border - pg. 189
 Polling - pg. 216
 Value Control - pg. 220
 Appearance - pg. 195
 Scale - pg. 217
 Behavior - pg. 199

4. If needed, type the server name and path in the **Server Name** box.
 If the data is being stored on the same computer where OpenController is running, the default setting is fine. The server name can be found in the **Data Tank/Data Storage** dialog box in OpenWorkbench.
5. Click the **...** button in the **Primary Target** box, to display the **Select Target** dialog box.
6. Using the **Select Target** dialog browse for and select a target.
7. In the **Position Max** box, enter the maximum value to be displayed for the slider.
8. In the **Position Min** box, enter the minimum value to be displayed for the slider.
9. Specify the desired step in the **Tick Precision** box
10. Click **OK**.

A basic slider is created. Before running the control the corresponding OpenWorkbench file must be open and a protocol should be running. To run the control, click **Run!** on the menu bar.

Creating a Knob

To quickly create a knob:

1. Click the **Controls** menu, point to **Sliders/Knobs**, and click **Knob**.
 The pointer changes to indicate that the control can be added.
2. Click the grid to position the upper-left corner of the control.
 The control is added to the grid area.
3. Double-click the control to display the **properties dialog** box.
 The dialog box opens with the most commonly changed settings displayed. Related settings are grouped together by color. Other settings are available by clicking the **Parameter Group** box and selecting a **settings group**.

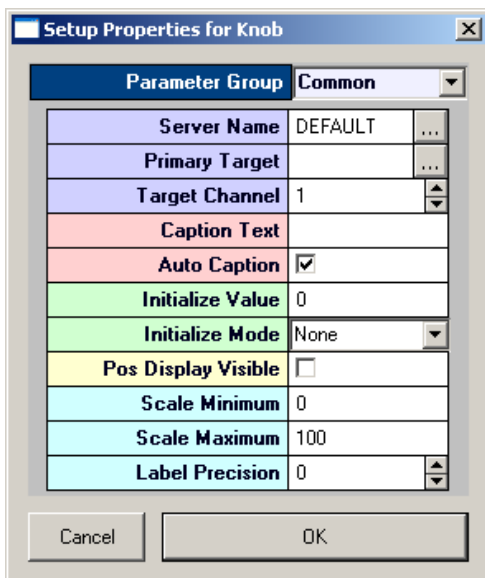

Settings groups include:

Common - pg. 204
 Target(s) - pg. 219
 Caption/Border - pg. 189
 Polling - pg. 216
 Value Control - pg. 220
 Appearance - pg. 195
 Layout - pg. 214
 Scale - pg. 192

4. If needed, type the server name and path in the **Server Name** box.
 If the data is being stored on the same computer where OpenController is running, the default setting is fine. The server name can be found in the **Data Tank/Data Storage** dialog box in OpenWorkbench.
5. Click the **...** button in the **Primary Target** box, to display the **Select Target** dialog box.
6. Using the **Select Target** dialog browse for and select a target.
7. In the **Scale Minimum** box, enter the minimum value for the knob.
8. In the **Scale Maximum** box, enter the maximum value for the knob.
9. Specify the desired precision in the **Label Precision** box.
10. Click **OK**.

A basic knob is created. Before running the control the corresponding OpenWorkbench file must be open and a protocol should be running. To run the control, click **Run!** on the menu bar.

Spike Discrimination and Sorting

About Spike Discrimination and Sorting

With OpenController, users can automatically set spike discrimination thresholds and sort spikes in real-time. The automated features of the Snippet Sort controls allow users to quickly assess unit activity across multiple channels without resorting to a tedious process of manually setting the threshold and then sorting spikes for each channel on a high channel count system. Once the system has set the threshold and done spike sorting, users can assess the quality of the process and manually modify the threshold and sort windows.

The Scrolling Threshold control implements control of the threshold level for discriminations and Snippet Sort implements time-voltage window sorting.

Creating a Scrolling Threshold Control

To quickly create a scrolling threshold control:

Note: Before creating the control, start OpenWorkbench and open a configuration file which includes a Store for spike sorting. The Scrolling Threshold control can only be used if a component such as SortSpike2 is included in the data generating construct. (See Type4: Signal Snippets, page 337 or Signal Snippets with Spike Sorting, page 339 for more information.) If SortSpike or FindSpike are used, only the low threshold is controlled using the Scrolling Threshold Control. The high threshold for SortSpike can be controlled in the Snippet Sort Control. For more information see Implementing Artifact Rejection through OpenController, page 163.

1. Click the **Controls** menu, point to **Advance Controls**, and click **Scrolling Threshold Control**.

The pointer changes to indicate that the control can be added.

2. Click the grid to position the upper-left corner of the control.

The control is added to the grid area.

3. Double-click the control to display the **properties dialog** box.

The dialog box opens with the most commonly changed settings displayed. Related settings are grouped together by color. Other settings are available by clicking the **Parameter Group** box and selecting a **settings group**.

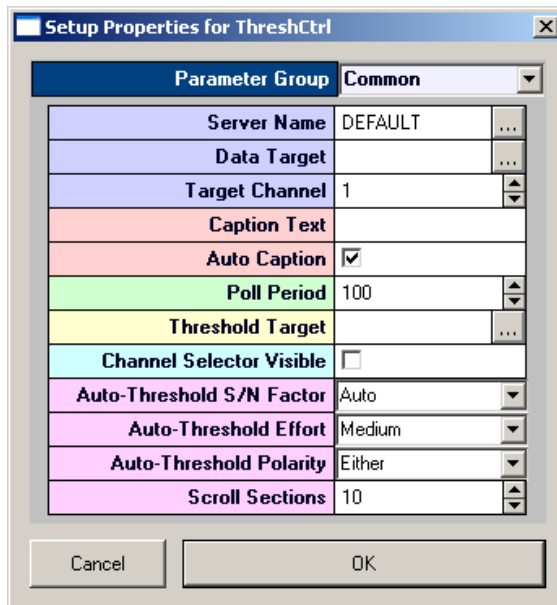

Settings groups include:

Common - pg. 209
 Target(s) - pg. 219
 Caption/Border - pg. 189
 Polling - pg. 216
 Value Control - pg. 220
 Data/Source Select - pg. 190
 Behavior - pg. 198
 Channel Selector - pg. 190
 Refresh Control - pg. 190
 Scaling - pg. 192
 X-Axis Setup - pg. 193
 Y-Axis Setup - pg. 194
 Appearance - pg. 195
 Margins - pg. 191
 Colors - pg. 190

4. Select a valid target for the control and make any other property setting changes as needed.

To select the target:

1. Click the look-up button  in the **Data Target** box. The **Select Target** dialog box opens.
2. In the target hierarchy, expand the **Stores** tree and select the correct Store name (such as a snippet Store or a plot decimated Store).

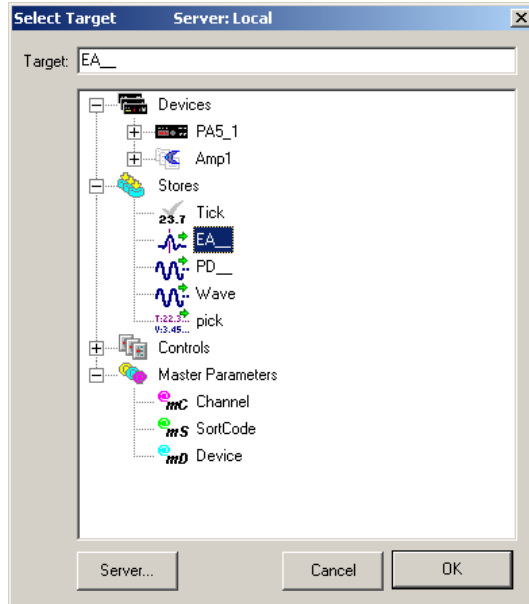

To select the Threshold Target:

1. Click the look-up button  in the **Threshold Target** box. The **Select Target** dialog box opens.
2. In the target hierarchy, expand the **Devices** tree and select the correct Device name (that is, the Device running a circuit which includes the signal snippet with spike sorting data construct).
3. Expand the **Scalars** tree and select the parameter tag that will serve as the target for the threshold. To set the target for all channels select the tag without the channel number (for example: aEa~). To set the tag for only one channel, expand the hierarchy to display the available channels and select the tag for the desired channel (for example: aEA~1).

Note: To set the parameter for multiple devices running the same circuit, modify the target name by removing the device component (for example: aEa~ NOT Amp1.aEa~)

5. Click **OK**.

Note: If the stream is stored with a different resolution than 32-bit, it will usually be scaled. Be sure to set the Threshold Scaling Factor (located in Setup Properties, Parameter Group Behavior) to the inverse of the scale factor used by the component performing the data compression.

For example, if the scale factor (SF) of a PlotDec16 component is set to 1e+006, be sure to set the Threshold Scaling Factor to 1e-006.

A scrolling threshold control is created. Before running the control the corresponding OpenWorkbench file must be open and a protocol should be running. To run the control, click **Run!** on the menu bar.

Creating a Snippet Sort Control

To quickly create a snippet sort control:

Note: Before creating the control, start OpenWorkbench and open a configuration file which includes a Store for spike sorting.

The Snippet Sort control can only be used if a SortSpike, SortSpike2, or SortSpike3 component is included in the data generating construct. (See Signal Snippets with Spike Sorting, page 339 for more information.) In the signal snippet construct the Sort_Code flag must be set to **YES**.

1. Click the **Controls** menu, point to **Advance Controls**, and click **Snippet Sort Control**.
The pointer changes to indicate that the control can be added.
2. Click the grid to position the upper-left corner of the control.
The control is added to the grid area.
3. Double-click the control to display the **properties dialog** box.

The dialog box opens with the most commonly changed settings displayed. Related settings are grouped together by color. Other settings are available by clicking the **Parameter Group** box and selecting a **settings group**.

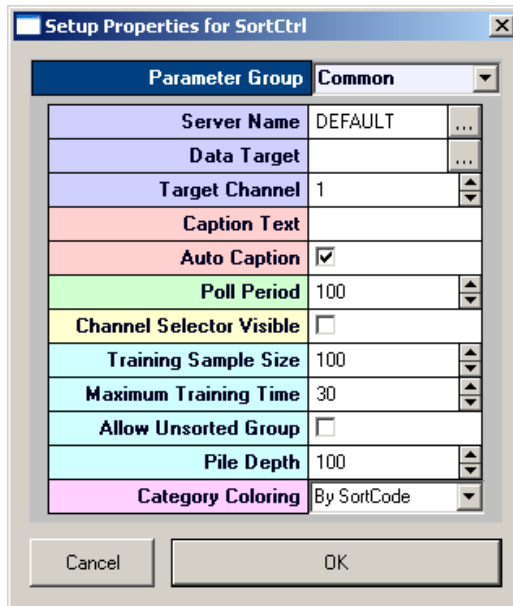

Settings groups include:

Common - pg. 212
 Target(s) - pg. 219
 Caption/Border - pg. 189
 Polling - pg. 216
 Value Control - pg. 220
 Data/Source Select - pg. 190
 Behavior - pg. 199
 Channel Selector - pg. 190
 Refresh Control - pg. 190
 Scaling - pg. 192
 X-Axis Setup - pg. 193
 Y-Axis Setup - pg. 194
 Appearance - pg. 195
 Margins - pg. 191
 Colors - pg. 190
 Filtering - pg. 191

4. Select a valid target for the control and make any other property setting changes as needed.

To select the target:

1. Click the look-up button  in the **Data Target** box. The **Select Target** dialog box opens.
2. In the target hierarchy, expand the **Stores** tree and select the correct Store name (that is, the Store which includes the signal snippet with spike sorting data construct).

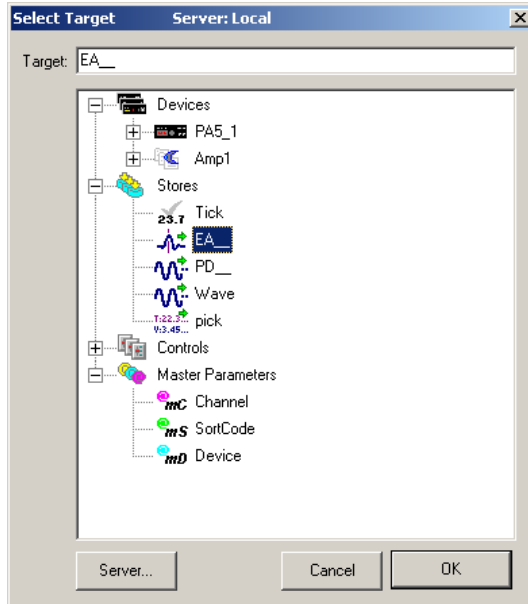

5. Click **OK**.



A snippet sort control is created. Before running the control the corresponding OpenWorkbench file must be open and a protocol should be running. To run the control, click **Run!** on the menu bar.

Using the Scrolling Threshold and Snippet Sort Controls

When a protocol is running, spike discrimination and sorting can be accomplished from OpenController using the Scrolling Threshold control and the Snippet Sort control. Typically, these controls are used together allowing the user to set the spike threshold while viewing a pattern of spike activity in one plot and sort spikes while viewing candidate waveforms in another.

Note: These controls rely on standard OpenEx data constructs. Typically a SortSpike2 component should be included in the data generating construct (See Signal Snippets with Spike Sorting, page 339 for more information). In the signal snippet construct the Sort_Code flag must be set to **YES**.

To use the scrolling threshold and snippet sort control:

1. Start the OpenWorkbench protocol and Run the Controller.
2. Click the  **Toggle Mode** button or the  **Run** button on the toolbar to run the control

The Scrolling Threshold control is animated with scrolling waveform data and a threshold marker (green line) is displayed for spike discrimination.

To set the threshold automatically:

- Right-click the plot and click Auto Threshold or Auto Threshold All on the shortcut menu.

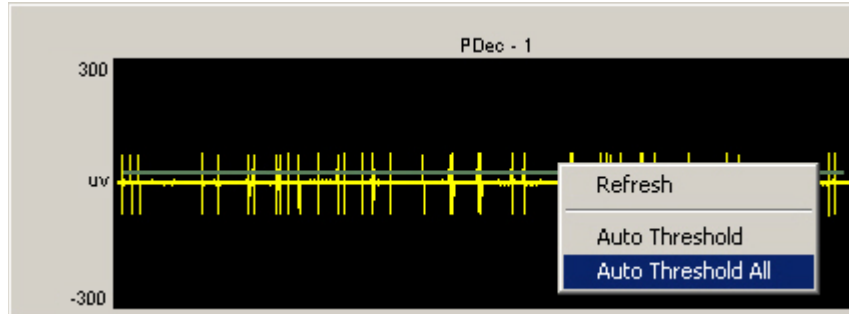

Auto Threshold - sets a threshold for the current channel.

Auto Threshold All - sets a threshold for all channels with the target defined in the control's properties.

The auto-thresholding feature acquires information about the signal to noise ratio of the signal and, based on the size of the signal, determines an optimal threshold that will detect any signal activity above the noise floor. If the spike size is large then the threshold will be set higher than if the spike size is small. A fixed signal to noise level can be set by modifying the control's Behavior parameters.

The direction of the threshold discriminator depends on the specified Threshold Target. Typically the target is the Threshold parameter of a SortSpike2 component and, by default, the threshold is unidirectional and will be adjusted based on +/- values. A bidirectional threshold can be specified by modifying the Use Sign parameter of the SortSpike2 component.

When needed, the threshold can also be set or adjusted manually. See Using the Scrolling Threshold and Snippet Sort Controls Manually, page 158 for more information.

The Snippet Sort control is animated with snippet waveforms and a threshold marker (green line) is displayed for the window discriminator. Because threshold is controlled from the Scrolling Threshold control, the user need not adjust this marker. If SortSpike is used, an upper threshold (pink line) might appear. This marker is controlled manually.

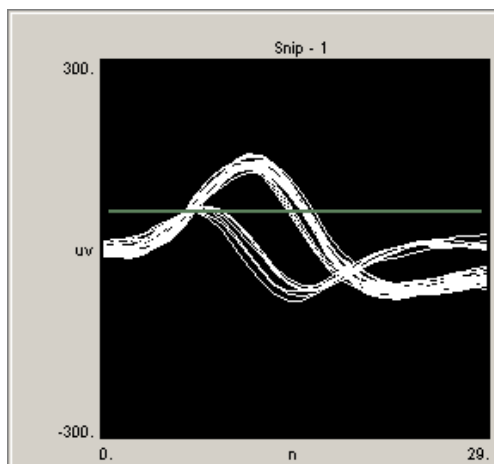

To sort spikes automatically:

- Right-click the plot and click Auto Sort or Auto Sort All on the shortcut menu.

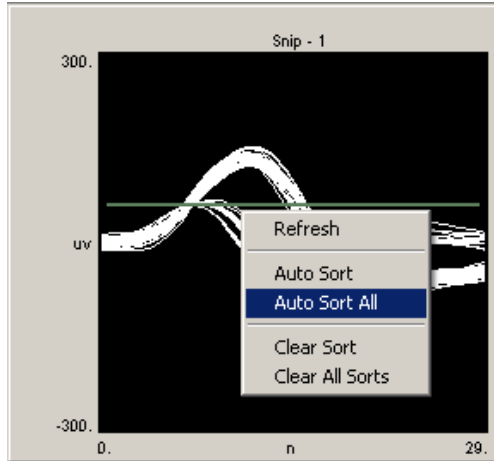

Auto Sort - sorts spikes for the current channel.

Auto Threshold All - sorts spikes for all channels in the data target (Store) defined in the control's properties.

The auto-sort feature uses a basic system for determining the number of potential units acquired on a channel. A simple algorithm is used to separate out candidate spikes. A series of cumulative frequency plots of the voltage distribution at each time interval is generated. Distributions that have inflection points (i.e. that are bimodal or multimodal) will be used to determine the time voltage window.

While sorting is ongoing a progress bar is displayed. When sorting is complete, time-voltage bars are added and positioned automatically.

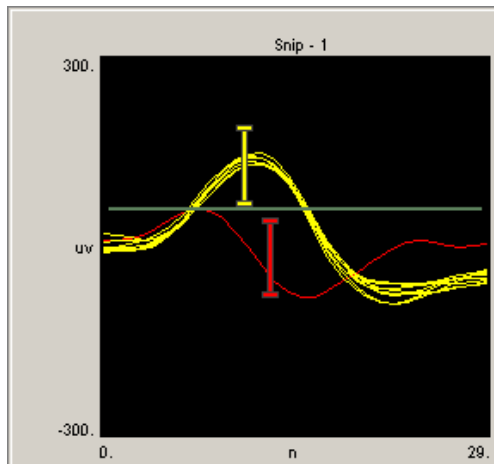

Note: Gray traces are snippets that will be recorded as unassigned. The sort code value for these snippets is set to 0.

When needed, the spikes can also be sorted manually.

Using the Scrolling Threshold and Snippet Sort Controls Manually

When a protocol is running, manual spike discrimination and sorting can be accomplished from OpenController using the Scrolling Threshold control and Snippet Sort control. While these two controls are designed to be used together they can also be used independently. This section provides information about using these controls for manual discrimination and spike sorting. Manual operation is most often used to make adjustments to the automated threshold and sorting results.

Scrolling Threshold Control

When this control is run a threshold marker is displayed. If the threshold marker is not shown, it can be displayed using auto threshold or by pressing and holding down the Shift key and dragging the mouse up or down to adjust the plot scale. Ctrl + double-click can sometimes be used to display the threshold marker. Dragging a marker across the edge of the plot will remove the marker. A confirmation message will be displayed before the marker is removed.

To set the threshold manually:

- Drag the threshold marker into position. This defines the desired magnitude range of the waveforms. The direction of the threshold marker (green bar) depends on the specified Threshold Target. Typically the target is the Threshold parameter of a SortSpike2 component and, by default, the marker is unidirectional and will be adjusted based on +/- values. A bidirectional marker can be specified by modifying the Use Sign parameter of the SortSpike2 component. If a SortSpike component is used the threshold bar typically implements the low threshold.

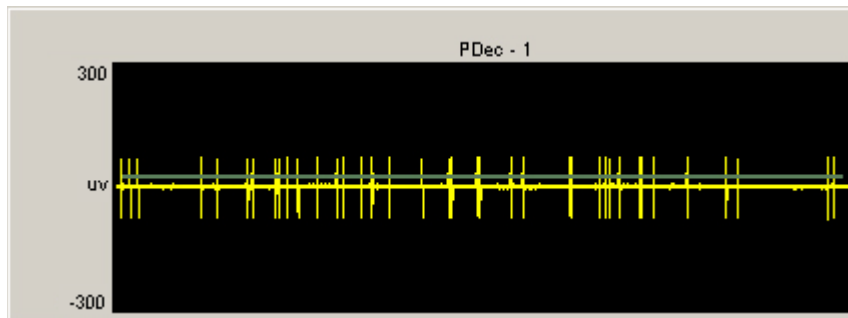

Note: A pink threshold marker might sometimes be seen. This marker should not be used.

Snippet Sort Control

When this control is run one or more threshold markers are displayed for the window discriminator. As in the Scrolling Threshold control, the direction of the primary threshold marker (bar slightly above the signal waveform in the previous diagram) depends on the specified Threshold Target (see Using the Scrolling Threshold and Snippet Sort Controls, page 156 for more information).

Note: the primary threshold marker in the Snippet Sort and scrolling threshold controls should be used to control the same target. Moving the marker in one control should move the marker in the other control.

When a SortSpike2 or SortSpike3 component is used only one threshold maker is needed. If a SortSpike component is used both low (green bar) and high (pink bar) thresholds can be implemented. If two threshold markers are needed and only one marker is displayed, press and hold down the Shift key and drag the mouse up or down to adjust the plot scale until the second marker is in view. If no threshold markers appear, Ctrl + double-click can be used to add the markers. For an alternate method of displaying the upper threshold marker, see Implementing Artifact Rejection, page 162.

To set the window discriminator:

- Drag the threshold markers into position to define the desired magnitude range of the waveforms. In the following example, the green marker (lower bar) is the lower threshold and the pink marker (topmost bar) is the upper threshold. To acquire only events within a range, the pink and green markers are positioned so that a voltage window is created.

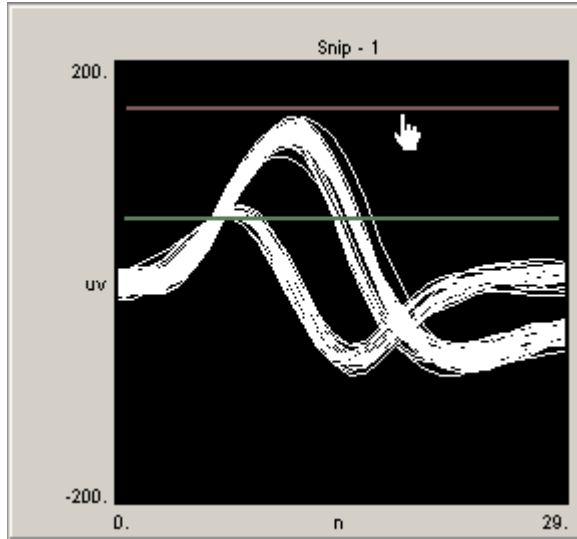

To add a time-voltage window:

- Hold down the control key and double-click in the center of the sort spike control.

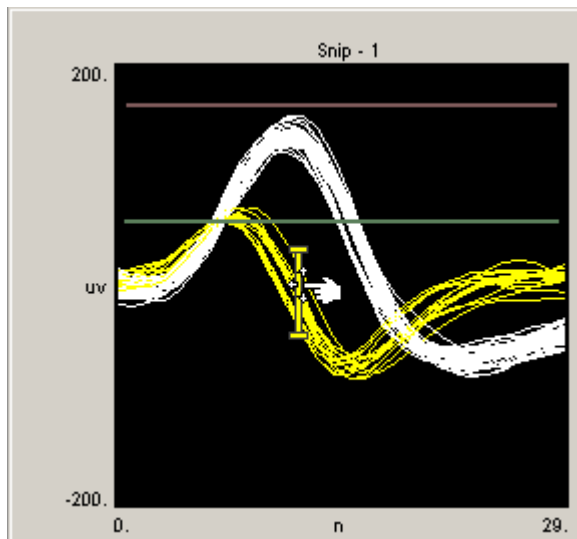

Note: Grey traces are snippets that will be recorded as unassigned. The sort code value for these snippets is set to 0.

To assign sort codes to visually identified spikes:

- Drag the time-voltage window sorter into position and resize the length of the bar as needed.

When the sorter is positioned the color of the snippets that pass through the sorter changes to match the color of the bar. Additional time-voltage windows can be added in the same way.

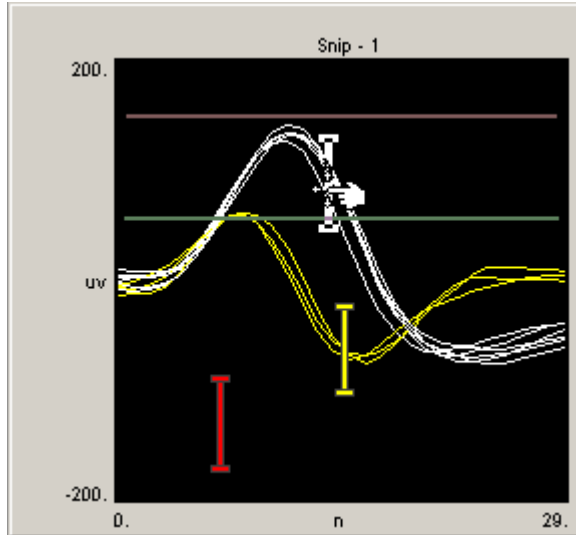

To remove a time-voltage window:

- Drag it off the edge of the control until the pointer changes to a small trash can. A message will be displayed to request confirmation of the deletion.

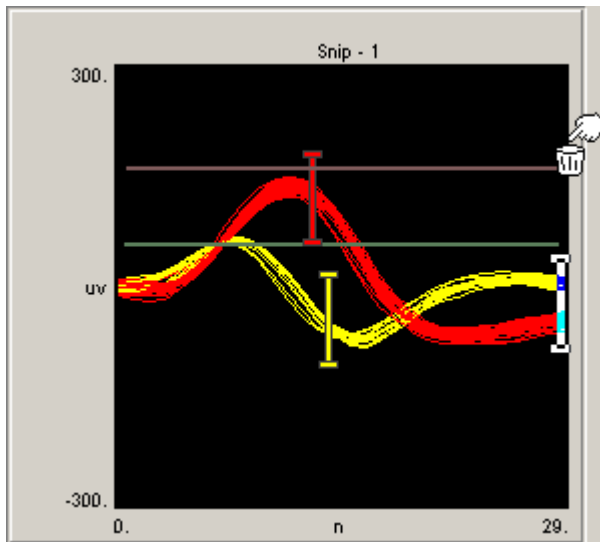

Note: The Snippet Sort control can only be used if a SortSpike, SortSpike2, or SortSpike3 component is included in the data generating construct. In the signal snippet construct the Sort_Code flag must be set to YES. The Scrolling Threshold control can be used with all spike components.

(See Type4: Signal Snippets, page 337 or Signal Snippets with Spike Sorting, page 339 for more information.) If SortSpike or FindSpike are used, only the low threshold is controlled using the Scrolling Threshold Control. The high threshold for SortSpike can be controlled in the Snippet Sort Control.

Determining Sort Codes

The spike sorting components sort spikes using time/voltage window discriminators.

SortSpike and SortSpike2

For the SortSpike and SortSpike2 components, a distance algorithm (distance from the center of the window) is calculated for waveforms that pass through two or more windows to determine which sort code value should be assigned.

For example, in the OpenEx Snippet Sort Control figure below, there are two time/voltage window discriminators. All but one spike passes through both of the windows. Since these spikes pass closer to the center of window 2, they are all given sort code 2 (coded in red). If any of these spikes had passed closer to the center of the yellow window, they would have been given sort code 1 (yellow). The spike that did not pass through either of the windows is given sort code 0 (white). Spikes passing through only Window 1 would be given sort code 1 and spikes passing through only window 2 would be given sort code 2.

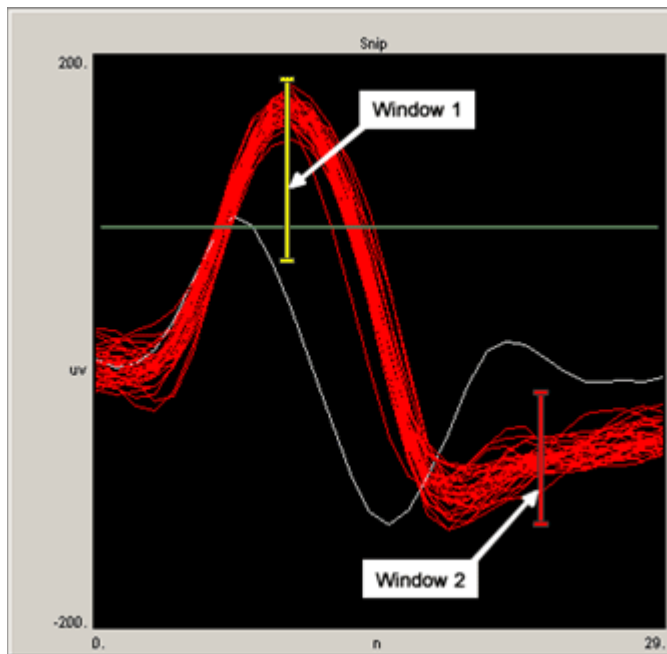

SortSpike3

SortSpike3 uses a different method to determine the sort code value. This component generates a sort code from ORing together a series of bits based on all of the windows the waveform passes through. The bit set for a particular window is determined by the following relationship:

$$2^{(\text{WindowNum} - 1)}$$

where WindowNum is determined by the order in which the windows are added in OpenEx. The distance measure discussed earlier is not used in this scheme.

For example, again in the following figure we have two time/voltage window discriminators. Spikes that only pass through Window 1 are given sort code 1 (yellow). Spikes that only pass through Window 2 are given sort code 2 (red). Spikes that pass through both Window 1 and Window 2 are given sort code 3 (light blue).

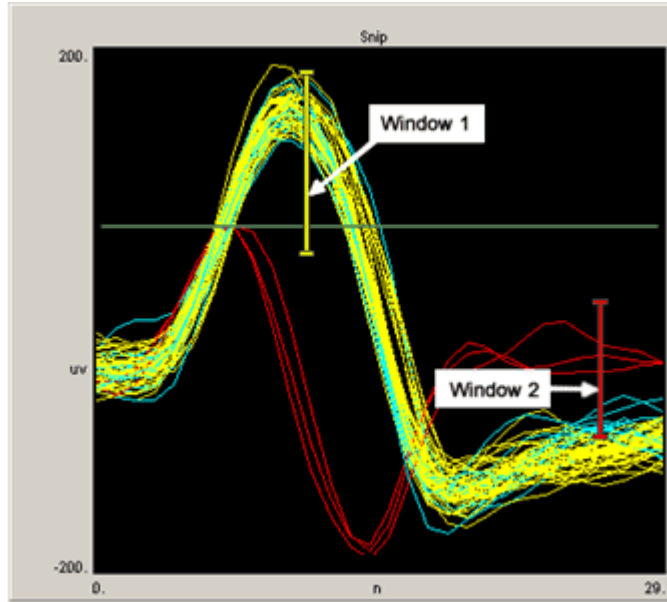

Since OpenEx will display 16 unique colors for the sort code values, no more than four time/voltage window discriminators should be used when using this component with OpenEx.

Implementing Artifact Rejection through OpenController

When OpenController's spike detection feature is implemented using the SortSpike component (see Signal Snippets with Spike Sorting, page 339), auto thresholding can be used to set the minimum threshold for spike detection (green threshold bar). Artifact rejection, however, is implemented by setting a maximum threshold value. The auto threshold feature does not set this value and does not display the maximum threshold or artifact rejection marker (pink threshold bar). To control the artifact rejection threshold and display the marker in the plot, you can set the value of the tag going into the second threshold line of the SortSpike component. One way to do this is to control the value using a slider.

Use the following steps to set the high threshold and display the threshold marker:

1. In Controller, click the **Controls** menu, click **sliders/knobs**, and click **slider**.
2. Click the workspace to add a slider, then double-click the new control to open the **properties dialog** box.
3. Click the **browse (...)** button next to **Primary Target**.
4. Select **Devices>Amp1>Scalars>bEA~** and click **OK**.
5. Enter a **Position Max** of **0.005** and a **Position Min** of **0**.
6. Enter a **Tick Precision** of **4**.
7. Save the changes and run the project.
8. Right-click the **Scrolling Threshold** plot (not the Snippet Sort Plot) and select **Auto Threshold**.
9. The green threshold marker will appear in both the scrolling threshold and snippet sort plots
10. Use the **slider** to set an **upper threshold**. This also brings the second threshold (pink) marker into view in the Snippet Sort plot. Note that you cannot set the artifact rejection in the Scrolling Threshold plot. A pink marker might be seen but is not implemented.
11. After the threshold marker is in view you can continue to set the value using the slider or adjust the value in the Snippet Sort control.

Master Mode

About the Master Mode Control

The master mode control can be used to access the OpenWorkbench protocol controls from OpenController. The Run! mode toolbar in OpenController includes Run and Stop buttons. Each of these buttons can be linked to OpenWorkbench protocol control modes. The Run button can be linked to the Record, Preview, or Standby protocol mode. The Stop button can be linked to the Standby or Idle protocol mode.

For example, the Stop button could be linked to the Standby mode. In Standby mode the protocol continues to run but no data is stored to the tank. The Run button could be linked to the Record mode so that when adjustments to the control settings are complete and the control is run, recording will resume.

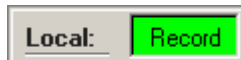

Master Mode Control

Creating a Master Mode Control

To quickly create a Master Mode control:

1. Click the **Controls** menu, point to **Advanced Controls**, and click **Master Mode Control**.

The pointer changes to indicate that the control can be added.

2. Click the grid to position the upper-left corner of the control.

The control is added to the grid area.

3. Double-click the control to display the **properties dialog** box.

The dialog box opens with the most commonly changed settings displayed. Related settings are grouped together by color. Other settings are available by clicking the **Parameter Group** box and selecting a **settings group**.

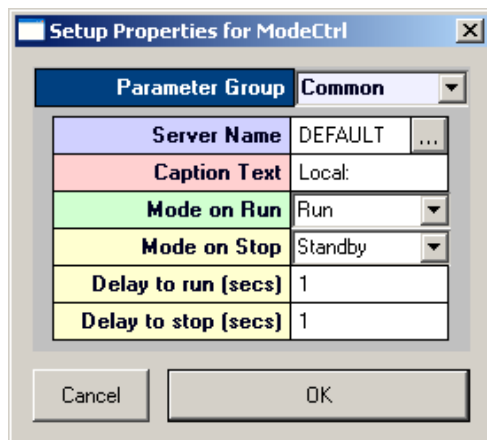

Settings groups include:

Common - pg. 207

Target(s) - pg. 218

Caption/Border - pg. 189

Behavior - pg. 198

4. If needed, type the server name and path in the **Server Name** box.

If the data is being stored on the same computer where OpenController is running, the default setting is fine. The server name can be found in the **Data Tank/Data Storage** dialog box in OpenWorkbench.

5. Click the **Mode on Run** box and select the protocol mode to be used when the OpenController Run button is clicked.
6. Click the **Mode on Stop** box and select the protocol mode to be used when the OpenController Stop button is clicked.
7. Click **OK**.

The Master Mode Control is created. Before the control can be used an OpenWorkbench file must be open and a protocol should be selected.

Data Tables

Creating a Data Table

To quickly create a data table control:

1. Click the **Controls** menu, point to **Tables/Scripting**, and click **Data Table**.
The pointer changes to indicate that the control can be added.
2. Click the grid to position the upper-left corner of the control.
The control is added to the grid area.

	A	B	C	D	
1					
2					
3					
4					
5	Rep	Rem
6					
7					
8					
9					
10					

3. Right-click **cell C5** to open the **Select Target** dialog box.
4. Using the **Select Target** dialog, browse for and select a target for the data values that will be entered in column C.

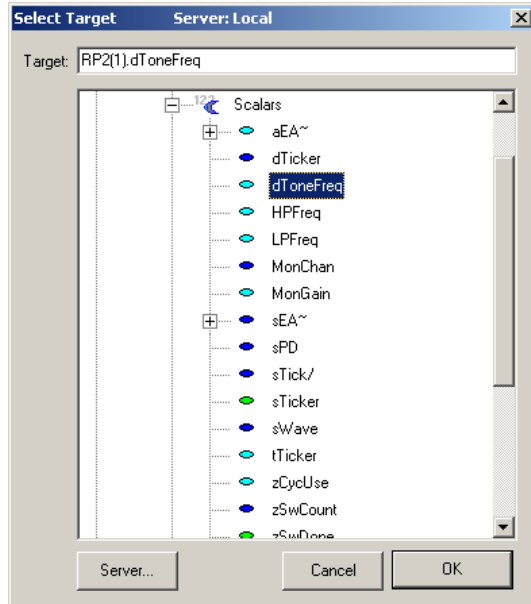

5. Click **OK**.
6. Click **cell C6** and enter the desired data value for the target selected in cell C5.

Note: values in the Data Table are displayed with a precision of 1. However, the actual value is retained. For example: a value of 0.0001 is displayed as 0.0, but 1.0001 will be passed to the target.

7. To move to cell C7 press the **DOWN ARROW** key.
8. Enter the remaining data values in the subsequent cells in **column C**.
9. Enter the desired number of repetitions for each value in the corresponding cell in **column A**.

	A	B	C
1			
2			
3			
4			
5	Rep	Rem	RP2(1).dToneFreq
6	3		100.0
7	3		200.0
8	3		400.0
9	3		800.0
10	3		1600.0
11			

A basic data table control is created. The user can add additional targets in subsequent columns. By default, the Ordering Scheme is manual, and the user controls the order in which table entries are utilized by clicking a row header while the control is running.

Synchronizing the Data Table

The data table may be used to send any type of data to parameter tags within the compiled circuit file. Typically, the data table will be used to control some aspect of a stimulus presentation. To ensure that the data values are sent at an appropriate time the data table should be synchronized with some target, such as the sweep number. The table can be synchronized by modifying the control property settings.

1. To display the **properties dialog** box, double-click the control.

The dialog box opens with the most commonly changed settings displayed. Related settings are grouped together by color. Other settings are available by clicking the **Parameter Group** box and selecting a **settings group**.

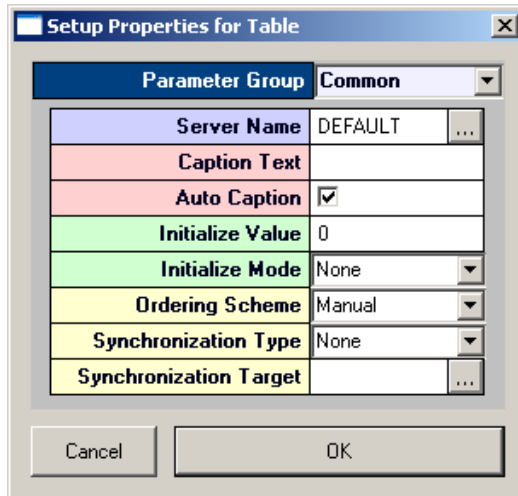

Settings groups include:

- Common - pg. 202
- Target(s) - pg. 218
- Caption/Border - pg. 189
- Polling - pg. 216
- Behavior - pg. 197

2. Click the **Ordering Scheme** arrow and choose a scheme from the list.
3. Select **Sequential** to send row values sequentially, **Random** to send row values randomly, **Manual** to select rows manually, or **Sync Tag** to use a tag to select the row.
4. Click the **Synchronization Type** arrow and choose a type from the list.
5. Select **On Tag Change** to send data values when ever the synchronization target changes or **On Tag True** to send data when ever the synchronization target value equals true.
6. Click the lookup button **...** in the **Synchronization Target** box and browse for a synchronization target in the **Select Target** dialog box.
7. Click **OK** to return to the **properties dialog** box.
8. Click **OK** to update the control with the modified settings.

The data table is now synchronized with a target and all rows will be used according to the selected ordering scheme. To use only selected rows click the row headers (use **SHIFT** + click to select adjacent rows or **CTRL** + click to select non adjacent rows) before running the control.

Using Formulas

The data table control supports the use of formulas and functions similarly to a Microsoft Excel spreadsheet. Formulas can be entered in any cell and may include cell references, such as =B2. Each formula must start with an equals sign and may include standard math operators such as * (multiply) and / (divide) or functions such as SUM and AVG (average).

The first four rows of the table are reserved for comments or reference values. The user can use a formula and cell references to multiply table values by some constant.

For example, a value in cell B1 could be referenced in a formula for the repetition values in column A as in the table below. All repetition values can then be changed by changing the constant in cell B1.

Note: the table displays formula results not formulas as in the example below.

	A	B	C	D
1	Repeat Constant	20		
2				
3				
4				
5	Repeats	Rem	RP2(1).Freq	...
6	=B1		500	
7	=2*B1		900	
8	=B1		1500	
9	=2*B1		1800	

VBScriptEx

About VBScriptEx

The VBScriptEx control provides a powerful way to add real-time logic to control stimulus parameters based on input from multi-channel digital inputs. It comes with a light IDE (Integrated Development Environment) for source code editing and debugging. It supports the standard VBScript language as well as extended functions providing screen output, flow control and access to OpenEx data target or other controls. Only one script control can be added to a single OpenController file.

The script control provides an editor for source code editing, line numbering, and syntax highlighting. The tool buttons on top of the editor provide two groups of functions: standard file operations and debugging operations. Standard file operations include creating new scripts, opening and saving a script files. Debugging operations include running, stopping, debugging and stepping through a script, adding and removing breakpoints, and opening the variable watch dialog.

Using the legacy VBScript control

The legacy VBScript control requires the VB script dll's and the VB script debugger. Microsoft does not allow TDT to distribute the Microsoft Script Debugger (VB script debugger). It is currently available for download from the Microsoft Website at:

<http://microsoft.com/downloads/details.aspx?FamilyId=2F465BE0-94FD-4569-B3C4-DFFDF19CCD99&displaylang=en>

Note: The Legacy VBScript control is still supported by TDT. The VBScriptEx control functions may not be supported by the Legacy VBScript control.

Creating a VBScriptEx Control

To quickly create a VBScriptEx control:

1. Click the **Controls** menu, point to **Tables/Scripting**, and click **VBScriptEx**.
The pointer changes to indicate that the control can be added.
2. Click the grid to position the upper-left corner of the control.
The control is added to the grid area.

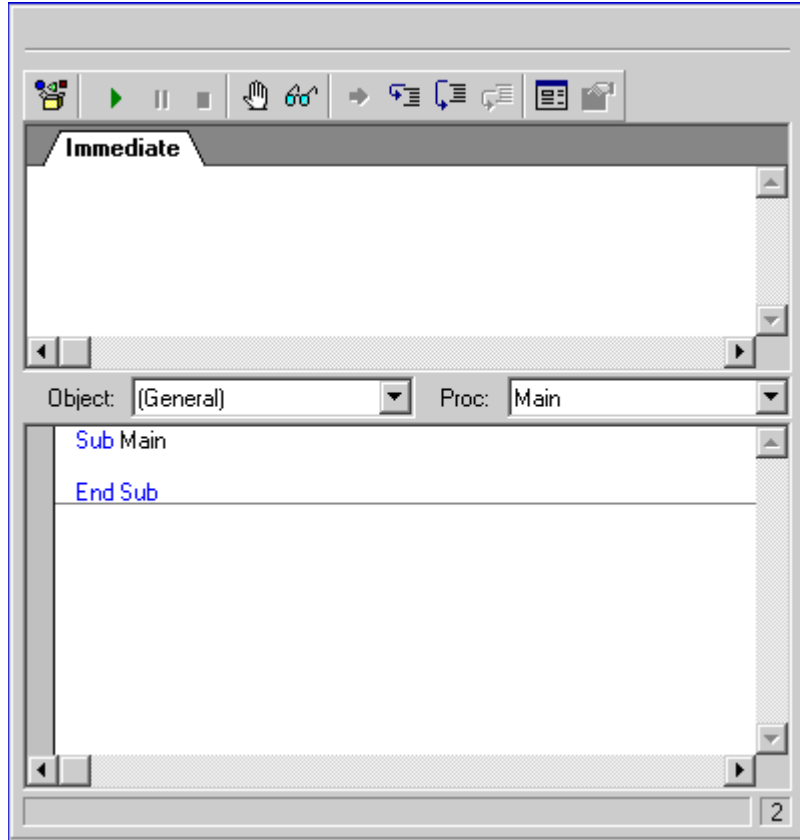

3. Double-click the grey area at the top of the control to display the **properties dialog** box. The dialog box opens with the most commonly changed settings displayed. Related settings are grouped together by color. Other settings are available by clicking the **Parameter Group** box and selecting a **settings group**.

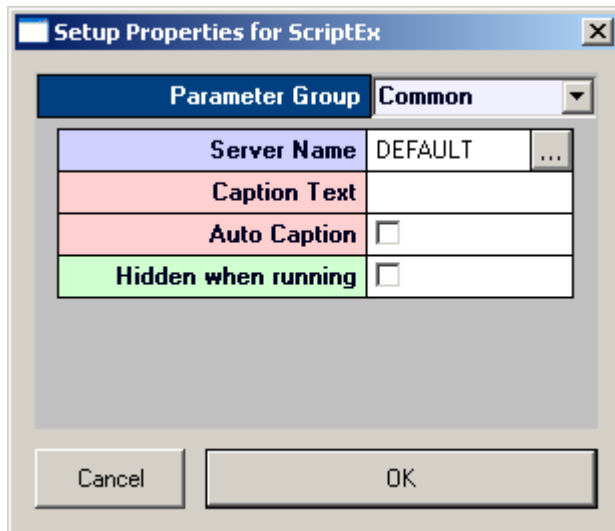

Settings groups include:

Common - pg. 214

Target(s) - pg. 220

Caption/Border - pg. 189

Behavior - pg. 200

4. If needed, type the server name and path in the **Server Name** box.
5. If needed, type the desired Caption Text. This will appear in the upper left corner of the control component.
6. If needed, select from these checkbox options for additional setting configurations.

Auto Caption: when the Auto Caption check box is selected, a caption will be automatically generated and applied to the control. The auto caption is based on the target value. Clear the Auto Caption check box to use a caption defined in the Caption Text box.

Hidden when running: when the controls are run the editor will be hidden from view.

7. Click **OK**.
8. Click in the editing area of the control and begin typing to write the script.

Writing VBScriptEx control scripts

The script control supports the standard VB Script language and TDT's extended functions. Extended functions add screen output and system flow controls to the VB Script language, and provide access to data targets by the simple read and write commands.

There are three types of data targets:

Device Targets

The script control can communicate with devices running on the OpenWorkbench server. The OpenWorkbench server loads multiple devices (RPco circuits saved in compiled circuit files) generated by RPvdsEx. Each RPco device contains tags for data input and output. The script performs stimulus control by communicating with these tags. To specify a device target, use the format DeviceName.TagName. For example, to access the "Frequency" tag in the device RP(2), use RP(2).Frequency.

Control Targets

The script control can also communicate with other controls within the same OpenController file. A script can write a value to other controls, such as a value watch control to display it, or change the caption text of the control. To specify a control target, use the control name and the property name in the format >ControlName.PropertyName.

For example, to write to the Value property of a value watch named Watch, use:

```
>Watch.Value
```

Default Control Target

When the script control is used to communicate with other controls within the same OpenController file it can also use the default control target. This is a subset of the control target using the default target value. Some controls have default target values such as the value watch's Value property. The default value comes into play if no value is specified.

For example,

```
>Watch
```

is equivalent to:

```
>Watch.Value
```

The following table lists a description of extended functions:

Prototype (case insensitive)	Returns	Description
Clear()	Void	Clears the text from the Immediate tab.
Print_(String text) Note: If using the Legacy version of VBScript this method is: Print(String text)	Void	Outputs the value of an expression to the Immediate tab. Example: Dim nVal, sVal nVal = 1 sVal = "Hello " Print_(nVal+1) Print_(sVal & "World") Output: 2Hello World
Println(String text)	Void	Outputs the value of an expression followed by a new line to the Immediate tab. Example: Dim nVal, sVal nVal = 1 sVal = "Hello " Println(nVal+1) Println(sVal & "World") Output: 2 Hello World
Quit()	Void	Halts execution of the VB Script.
Sleep(int msec)	Void	Suspends the execution for a specified amount of time in milliseconds. Example: Sleep(1000) 'sleep for 1 second
Read(String target)	Variant: value	Read a value from a target. Example: Dim target_dev, target_ctrl, val target_dev = "MyDevice.frequency" val = Read(target_dev) Print_(val) target_ctrl = ">knob.Value" Print_(Read(target_ctrl))

<p>Write_(String target, variant or constant)</p> <p>Note: If using the Legacy version of VBScript this method is:</p> <p>Write(String target, variant or constant)</p>	<p>True: successful False: failed</p>	<p>Write a value to a target.</p> <p>Example:</p> <pre>Dim target_dev, target_ctrl, val target_dev = "MyDevice.frequency" Write_(target_dev, val) target_ctrl = ">knob.Value" Write_(target_ctrl, val)</pre>
<p>GetSystemMode()</p>	<p>Long</p>	<p>Returns a long that specifies the devices current mode:</p> <p>0 = Idle 1 = Standby 2 = Preview 3 = Run</p>
<p>SetSystemMode(int newMode)</p>	<p>True: successful False: failed</p>	<p>Sets the devices current mode where newMode is:</p> <p>0 = Idle 1 = Standby 2 = Preview 3 = Run</p>
<p>IssueTrg(long TrgID, long TrgMode)</p> <p>Note: TrgID corresponds to Software trigger 1 – 10.</p>	<p>Long</p> <p>At this time, IssueTrg always returns a -1</p>	<p>Issues Software trigger 1 –10 on all active devices connected to the zBUS. The parameter TrgMode is reserved at this time and should be set to 0.</p> <p>Example:</p> <pre>IssueTrg(1,0)</pre>

Using the CRS VSG2/5 system with OpenEx

With the latest release of the OpenEx Interface TDT provides the ability to write VB Script that can control the CRS VSG2/5 stimulator using the underlying Stimulus Description Language (SDL). The CRS system gives experimenters the ability to precisely match stimulus presentation with acquired signals from evoked potentials or single unit neurophysiology.

The ability of one application to control both stimulus and acquisition simplifies the integration process.

How It Works

TDT's OpenController runs a modified version of Visual Basic Script. Method calls to the System Description Language have been incorporated into the VB Scripting procedure.

All methods that run under the SDL also run under VB Script. Since the method calls are all done in VB script, all values are sent as variants and are returned as variants. There are two sets of methods.

System Status Calls

Most of these System Status Calls are not required for communication with the VSG2/5. They are included to insure compatibility with the CRS VSG2/5 hardware and software.

The following table lists a description of the VSG System Status functions:

Prototype (case insensitive)	Returns	Description
VSG_GetDeviceCommsType(long nDev, String PortID)	Long	Returns the Communication type (Single Computer, Dual Computer). nDev is the device handle for the VSG2/5.
VSG_GetDeviceIDstring(long nDev)	String	Returns the ID value associated with the handle. nDev is the device handle for the VSG2/5.
VSG_ErrorMessage(long errorCode)	String	Returns the string error message associated with the error code. errorCode is the device handle for the VSG2/5.
VSG_GetLogonState(long nDev)	Long	Returns the status of the communication between the computer and the VSG2/5 card (Returns TCP address and communication status or error). nDev is the device handle for the VSG2/5.
VSG_GetString(long nDev)	String	Returns the last String value associated with a function call. nDev is the device handle of the VSG2/5.
VSG_GetDeviceType(long nDev)	Long	Returns the device type (this will almost always be a VSG2/5). nDev is the device handle for the VSG2/5.

System Communication Calls

System Communication methods are used to control the VSG2/5 hardware and to start and stop the VB Scripts communication with the hardware.

The following is the description of the VSG System Communication functions:

Prototype (case insensitive)	Returns	Description
VSG_Init(String devName, Boolean forcelogon)	Long	<p>Required to initialize communication between the OpenEx application and the VSG2/5 hardware.</p> <p>Example: Returns the handle for the VSG2/5 hardware. This identifies the hardware device and is used by all other function calls to the hardware.</p> <p>Form <code>nDev=VSG_Init("",false)</code></p>
VSG_Close(long nDev)	Long	<p>Required to Close the communication link between the software and the VSG hardware.</p> <p>Example: nDev is the device handle for the VSG2/5. Closes communication with the VSG device.</p> <p>Form <code>VSG_Close(nDev)</code></p>
VSG_SetMode(long nDev, long mode, long value)	Long	<p>Sets the Stimulus Parameters for accessing the image. Use SetMode at the start of the VB script.</p> <p>Example: nDev is the device handle for the VSG2/5. Var1 is the Stimulus number, which is used for all other connections. Var2 indicates the sync signal out parameters used.</p> <p>Form <code>VSG_SetMode(nDev,Var1, Var2)</code></p>
VSG_WriteDirect(long devHandle, String command)	Long	<p>Sends SDL commands to the VSG2/5 hardware. Write direct is used to send all SDL commands to the hardware system.</p> <p>Example: nDev is the device handle for the VSG2/5. "command();" is any SDL command. All commands must start with a quote and end with a semicolon and end quotes. To include variable names ampersands should be used</p> <p><code>VSG_WriteDirect(nDev,"size(1,"& width &"",8);")</code></p> <p>This will change the size of target 1 to the set width. Note the need for the quotes and the ampersands.</p>

Running VBScriptEx control scripts

The VBScriptEx control can run only one script at a time. However, multiple OpenController applications can be running at the same time with each containing a script control. The script control can be run in either hidden or non-hidden mode.

Hidden when running: the editor will be hidden from view. This mode is normally used when the script directs the output to other controls. To run a script, click the **Run** button on the title tool bar. To stop, click the **Stop** button on the title tool bar.

Both the compilation and runtime errors are reported. The location of the error is highlighted during runtime. Error free VBScript will run automatically whenever the OpenController file is set to run.

Debugging VBScriptEx control scripts

The Interactive mode triggers the script debugger and provides some useful debugging tools.

Debugging can be performed using the debugging tool buttons, the associated accelerate keys, or by right-clicking anywhere on the IDE and selecting the corresponding command from the dialog pop-up menu:



Browse Object: Allows you to browse the library's object list including methods, and their parameters/return types.



Start/Resume (F5): runs the script to completion or resumes a paused script.



Pause (Esc): pauses the execution of the script.



End: stops the execution of the script.



Toggle Break (F9): inserts or removes a breakpoint on the line where the cursor is positioned. If a breakpoint is inserted on a non-executable statement, the debugger will step to the first available executable statement after the breakpoint.



Evaluate Expression (Shift + F9): Shows the value of the cursors currently selected expression in the Immediate messages dialog window.



Show Current Statement: Returns the cursor to the currently highlighted line while the execution is paused.



Step Into (F8): Execute the current line. If the current line is a subroutine or function call, stop on the first line of that subroutine or function. (If the script is not active, start it)



Step Over (Shift + F8): Execute to the next line. If the current line is a subroutine or function call, execute that subroutine or function completely.



Step Out (Ctrl + F8): steps out of the current subroutine or function.

The focus must be on the script control to make the accelerate keys (F5, F8, and F9) function. The focus will be lost from the script control when the window area outside the script control is clicked. Click the control to set focus on the script control.

Biquad Coefficient Generators

About Biquad Coefficient Generators

The System 3 platform relies primarily on digital filtering, with filters implemented through RPvdsEx components within the compiled circuit file. Biquad filters, inherently more stable than other IIR filters, are the filter of choice for many OpenEx applications. Their superior stability allows users to change filter coefficients on the fly, making them ideal for the OpenEx environment. The Biquad Coefficient Generator control is one of two ways OpenEx users can modify the coefficients of the Biquad filter.

Note: Filtering macros are available and offer cascaded highpass and lowpass filter sections with selectable order and dynamic filter coefficient updating for single and multichannel signals. TDT recommends using macros whenever possible. See Tutorial 1: Getting Started with OpenEx, page 11 for more information on how to add a real-time filter control using filtering macros.

- Within RPvdsEx there are several components that can be used to generate filter coefficients: ButCoeF1 (generates Butterworth coefficients for a first order Biquad), ButCoeF (generates Butterworth coefficients for an n^{th} -order Biquad), and ParCoeF (generates a parametric coefficient (equalizer filter) for a first order Biquad). The parameters of these components may be controlled from within the circuit or from an OpenEx control.
- Within OpenController, Biquad Coefficient Generators generate n^{th} order Biquad coefficients and allow users to set the filter properties of the Biquad (Lowpass, Highpass, Bandpass, or Notch). The order of the Biquad filter, or number of Biquads, is automatically detected and the correct number of coefficients is generated.

There are advantages and disadvantages to both methods. Using RPvdsEx components to generate the coefficients allows users to control the filtering properties independent of the Microsoft Windows operating environment. If precise timing of the filter changes is required then this would be the best choice.

The advantage of generating them through OpenController is two fold. First, you decrease the number of components used in the circuit. If the number of components is a limiting factor, this can generate a substantial savings in components. Second, removing the coefficient generators decreases the cycle usage of the system. In general, TDT recommends using OpenController's Biquad Coefficient Generators to change filter settings. However, if you require precise timing for these filter changes we recommend using the ButCoeF, ButCoeF1, or ParCoeF RPvdsEx components.

The examples below show the circuit constructs required to implement Biquad filtering either through OpenController or directly in the compiled circuit file. A Biquad filtering circuit construct is required for each biquad filter that will be implemented through OpenController.

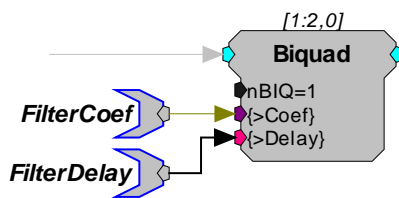

Biquad Filtering Using OpenController
Filter Settings Changed from OpenController

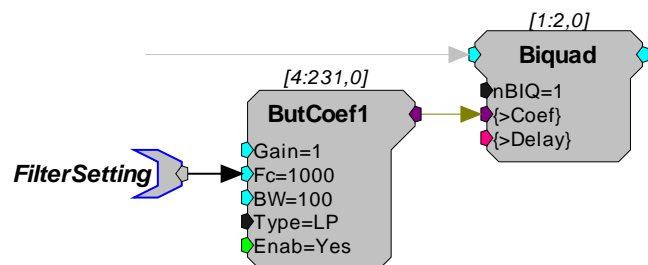

Biquad Filtering Using ButCoeF1 In RPvdsEx
Filter Settings Changed with RPvdsEx Coefficient Generator

In this example:

The **FilterCoef** parameter tag is used by OpenController to load the coefficient values for that filter setting to the Biquad. The **FilterDelay** parameter tag is used to reset the Biquad delay lines.

If the delay lines are not zeroed it is possible for the filters to crash.

These parameter tag names are suggested names. The parameter tags must be defined as the Coef Target and Delay Line Target in the control's property settings.

Using the Biquad Coefficient Generator Control

The control set below includes a filter coefficient generator (on the right) and a slider (on the left) to provide dynamic control of filter settings during the experiment. The filter type, Lowpass, Highpass, or Bandpass is set along with the default filter settings when the controls are created in OpenController. During an experiment the corner frequency (Fc) or bandwidth (BW) can be changed by typing a value in the appropriate box then pressing Enter or from a linked controller, such as the slider pictured in the following diagram.

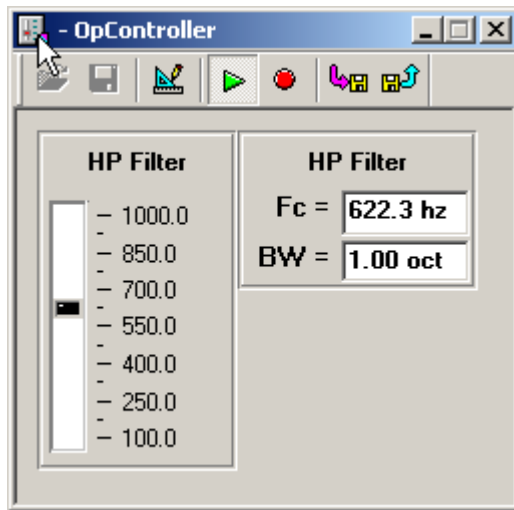

Control Set with a Biquad Coefficient Generator

Creating a Biquad Coefficient Generator

Two text boxes on the biquad coefficient generator control can be used to change filter settings during an experiment. The first is used to select the center, or corner frequency, of the filter and the second selects the bandwidth in octaves (The bandwidth setting only works with the Notch and Bandpass filter types). The steps provided below create a biquad coefficient generator control and a slider to control the filter settings. This is probably the most common use of the biquad coefficient generator.

1. Click the **Controls** menu, point to **Advanced Controls**, and click **Biquad Coefficient Generator**.

The pointer changes to indicate that the control can be added.

2. Click the grid to position the upper-left corner of the control.

The control is added to the grid area.

3. Double-click the control to display the **properties dialog** box.

The dialog box opens with the most commonly changed settings displayed. Related settings are grouped together by color. Other settings are available by clicking the **Parameter Group** box and selecting a **settings group**.

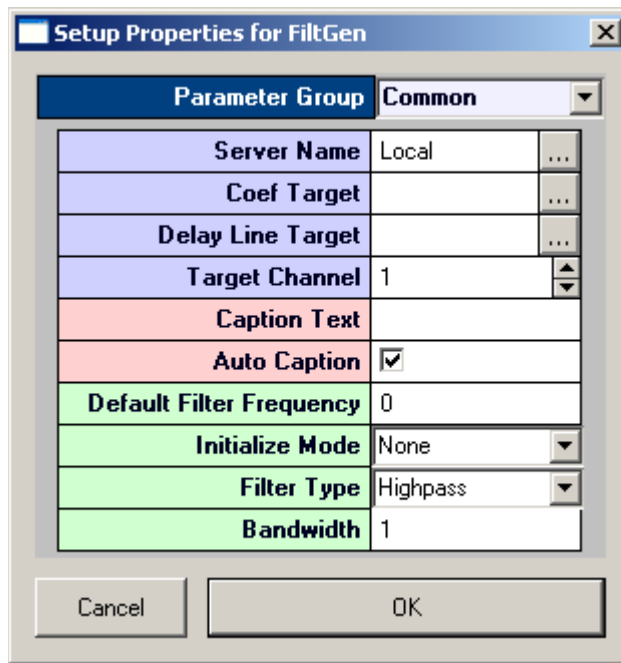

Settings groups include:

Common - pg. 201
 Target(s) - pg. 218
 Caption/Border - pg. 189
 Polling - pg. 216
 Filter Specification - pg. 191

4. If needed, type the server name and path in the **Server Name** box.
 If the data is being stored on the same computer where OpenController is running, the default setting is fine. The server name can be found in the **Data Tank/Data Storage** dialog box in OpenWorkbench.
5. In the **Coef Target** box select the parameter tag associated with the >Coef line in the Biquad component. The parameter tag will be in the following location in the **Select Target Tree**: Devices|Name|Buffers|.
6. In the **Delay Line Target** box select the parameter tag associated with the >Delay line. The parameter tag will be in the following location in the **Select Target Tree**: Devices|Name|Buffers|.
7. In the **Filter Type** box, select **Highpass, Lowpass, Bandpass, or Notch**.
8. If Bandpass is selected, specify the **bandwidth** of the filter in octaves in the **BW** box.
9. Click **OK**.

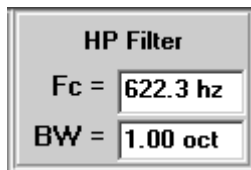

10. Add a slider to the control workspace.
11. In the slider **property settings** dialog box, select the proper position parameters and primary target. The target is located in the following location in the **Select Target Tree**: Control|cFilterGen-x|Filter Specification|Filter Frequency.
12. Click **OK**.

At this point you should be able to control the filter settings of the Biquad from the slider. To test the control set, toggle to run! mode and move the slider. The filter settings should change in the Fc = box.

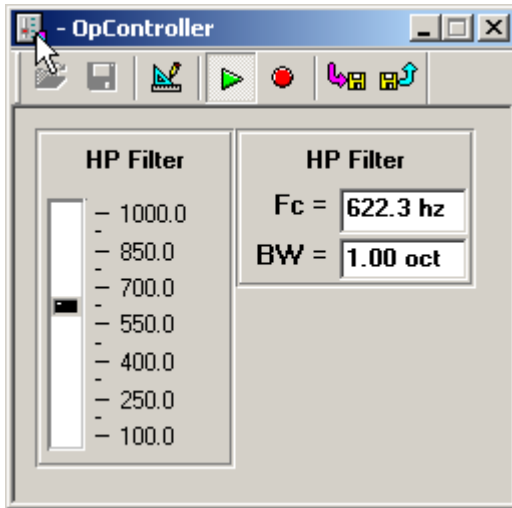

Other Control Types

About Graphic Frames

A frame can be used to create a caption and border for a group of controls. After the frame has been added, other controls can be dragged to it.

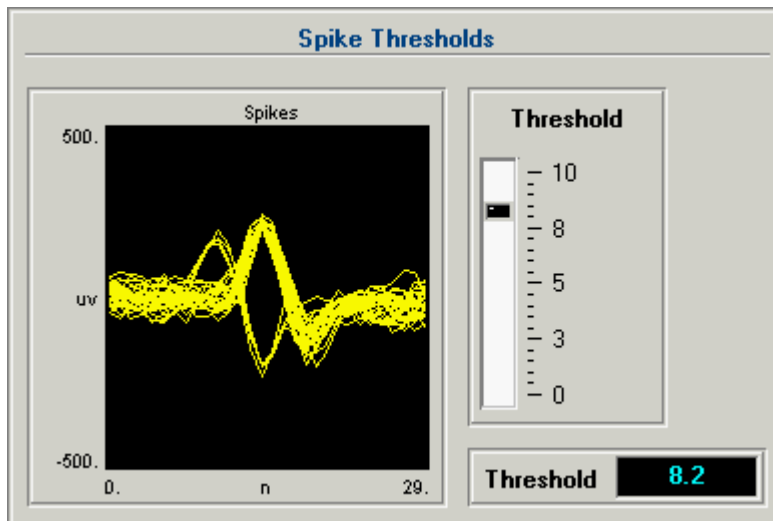

Frame Grouped with Controls

In this example a frame has been used to group a pile plot with a slider controlling the spike threshold and a value watch displaying the current threshold value.

Creating a Frame

To quickly create a frame:

Click the **Controls** menu, point to **Misc.**, and click **Graphic Frame**.

The pointer changes to indicate that the frame can be added.

1. Click the grid to position the upper-left corner of the frame.
The frame is added to the grid area.
2. Double-click the frame to display the **properties dialog** box.
3. Type the desired caption in the **Caption Text** box.
4. Resize the frame and drag controls to be added to the frame.
5. Select the frame and related controls.
6. Click the **Edit** menu, and click **Group**.

A basic frame is created. Before running controls the corresponding OpenWorkbench file must be open and a protocol should be running. To run the controls, click **Run!** on the menu bar.

About SigGen Control

The SigGen control gives users access to TDT's SigGenRP signal generation application. SigGenRP is a program for generating simple and complex waveforms. The SigGenRP application allows users to control all properties of the signal. Users familiar with SigGenRP can use their existing SigGenRP files with little modification or change. This control provides users with the ability to use and control a stimulus file designed with SigGenRP as part of an OpenEx experiment.



SigGen Control

The SigGen control is a partial implementation of the SigGen stimulus system. It allows users to move about the SGI (SigGen Index) to determine the signal properties. The toggle switch to the right allows the user to select the next or previous SGI.

If users want to save information about the SigGen parameter controls, the best way would be to generate a spreadsheet with the SigGen variables and SGI index and save that so that it can be read by the DataTable format (see Data Tables in the OpenController Reference, page 165).

The outputs from the data table can be set up to store the parameter variables in an asynchronous scalar format and used as epoch events.

Only one SigGen Engine control can be added to a single OpenController file. If multiple SigGen Engine controls are required, the user must create individual OpenController files for each control.

For a detailed description of how to use SigGenRP please refer to the SigGenRP manual. To learn more about SigGenRP call TDT at 386-462-9622.

SigGen Signals are generated on the PC and then loaded to and played from the SerSource component (see the RpvdsEx Help). The following circuit construct must be added to the RpvdsEx circuit. In most cases the SigGen file will be used with a sweep based stimulus protocol.

The information below assumes that the circuit construct is part of a circuit that includes a sweep or condition construct and that the construct is controlled by an OpenWorkbench protocol that uses sweep settings. It is possible to use SigGen circuits in other circuits and OpenWorkbench protocols, however, the circuit control must be designed by the end user.

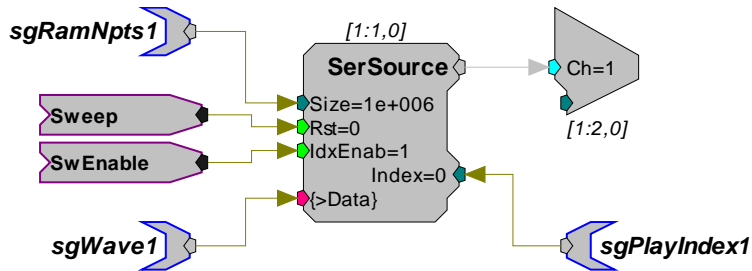

sgRamNpts1 parameter tag determines the size of the buffer.

sgWave1 parameter tag loads the SigGen file to the SerSource component.

Sweep resets the buffer before the start of the next stimulus. (This should be changed to condition if condition control settings are used rather than sweep control settings in the OpenWorkbench protocol.)

SwEnable plays out the signal from a sweep based protocol. (This should be changed to CoEnable if condition control settings are used rather than sweep control settings in the OpenWorkbench protocol.)

Creating a SigGen Engine Control

The description below creates a SigGen control and a Slider Switch that selects the proper SGI index.

1. Click the **Controls** menu, point to **Advanced Controls**, and click **SigGen Control**.
The pointer changes to indicate that the control can be added.
2. Click the grid to position the upper-left corner of the control.
The control is added to the grid area.
3. Double-click the control to display the **properties dialog** box.

The dialog box opens with the most commonly changed settings displayed. Related settings are grouped together by color. Other settings are available by clicking the **Parameter Group** box and selecting a **settings group**.

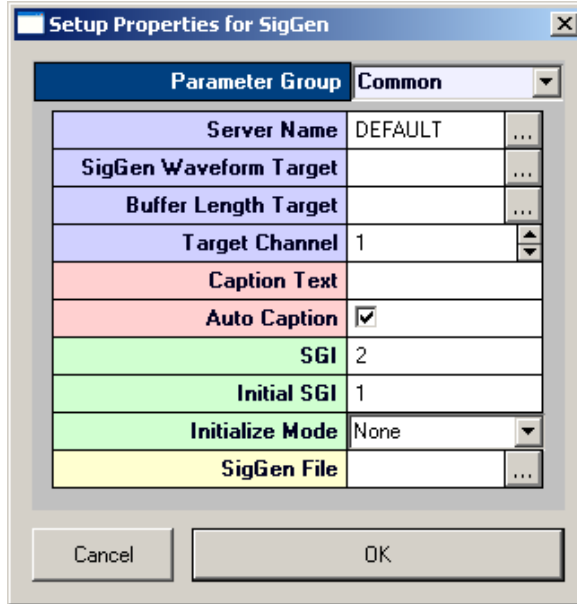

Settings groups include:

Common - pg. 211
 Target(s) - pg. 219
 Caption/Border - pg. 189
 Polling - pg. 216
 Value Control - pg. 220
 SigGen Specs - pg. 192

4. If needed, type the server name and path in the **Server Name** box.
 If the data is being stored on the same computer where OpenController is running, the default setting is fine. The server name can be found in the **Data Tank/Data Storage** dialog box in OpenWorkbench.
5. In the **SigGen Waveform Target** box select the parameter tag associated with the SigGen waveform buffer. The parameter tag will be in the following location in the **Select Target** tree: Devices|Name|Buffers|. (The color of buffer icon will be pink to indicate a memory buffer as opposed to a coefficient or delay line.)
6. In the **Buffer Length Target** box select the parameter tag associated with the length of the buffer. The parameter tag will be in the following location in the **Select Target** tree: Devices|Name|Scalars|. (The color of the scalar will be light blue to indicate an integer value.)
7. Select the starting SGI in the **Initial SGI** box.
8. Click the **Parameter Group** box, and click **SigGen Specs** in the drop down list.
9. In the **SigGen File** box, select the SigGen file to use with the SigGen control.
10. If necessary, select the **maximum** and **minimum SGI index**.
11. Click **OK**.
12. Add a slide switch to the control workspace and select the proper position and target parameters. The Primary Target is located in the following location in the **Select Target** tree: Control|cSigGen-x|Value Control|SGI.
13. Click **OK**.

At this point you should be able to control the SigGen index control from the slider switch. To test this run the controller and move the slider. The SGI value box should change.

Linking Controls

About Linking Controls

Linking Controls allows controls to send data to and receive data from other controls. Data from modifier controls can be sent to visualization tool controls, such as status indicators or gauges. For example, the value sent from a Slider could be sent both to a parameter tag running on a Device and to a setting for a visualization tool, such as an Led Indicator.

The Advantages of Linking

Links provide a logical structure to groups of controls and allows users to modify the parameter settings of one control based on the source information of another control. For example, a user may want to monitor the signal output from a data channel. A modifier control such as a slider determines the monitor channel. This output can be sent to a Visualization control so that the graph shows the correct monitor channel.

How It Works

Controls communicate to each other through Targets. Targets are defined as primary, secondary (alternate), source, or data targets.

Primary Targets: change a parameter tag on the circuit or a parameter of another control and occur in modifier controls. A primary target sends a new value each time the system is polled.

Alternate Targets: are similar to primary targets. They allow users to modify multiple parameter tags or control parameter settings with a single control. Alternate targets are associated with modifier controls. An alternate target may be a parameter tag on a different device or a visualization control parameter setting.

Source Targets: acquire values from parameter tags, and other controls. When a value is acquired from a control the Value setting in the Value Control parameter group settings is the source. Source targets are associated with visualization controls.

Data Targets: acquire values from parameter tags and other controllers. Data targets are associated with visualization controls.

Each control has a unique name. When linking controls the control name is used as a part of the target path for another control. The control name can be found in the control's property setting dialog box, in the My Name box of the Target(s) parameter group. A name will be generated automatically or the user can enter a name of their choice.

Nomenclature for Controls

- >
 The greater than sign is used with primary or alternate targets and sends a value to another control parameter setting.
- <
 The less than sign is used with source targets or control parameter settings and acquires a value from another controller parameter.
- device.Target**
control.Target
 A period separates the device or control from the variable it modifies. For example deviceX.Filter would modify the Filter parameter tag on deviceX. controlX.Target Channel would modify the Target Channel parameter setting in the Target parameter group for controlX.
- *
 The asterisk is a wild card designator that can be added to device names or parameters. For example, if a compiled circuit file is mirrored (that is, the same compiled circuit file is loaded onto multiple devices and the devices are named in standard form such as acq1, acq2, ...) then the designation acq*.Filter would modify the Filter parameter tag on all Devices whose names begin with acq.

Linking Controls

To link controls simply open the OpenWorkbench configuration file, then Open OpenController and create each control in the control set as needed. In the target box for the linked control, enter a path or use the Select Target Dialog to browse to the desired setting for another control in the same control set.

Example: Linking a Slider and a 7 Segment Display

Typically a modifier and a visualization control are linked. In this example, a 7 segment display will be linked to a slider.

1. Open the OpenWorkbench configuration file.
 - Note:** the devices should already be established and compiled circuit files should be assigned.
2. Open OpenController. A blank new OpenController file is created and displayed in Design mode.
3. To create the slider, click the **Control** menu, point to **Sliders/Knobs**, and click **Slider**.

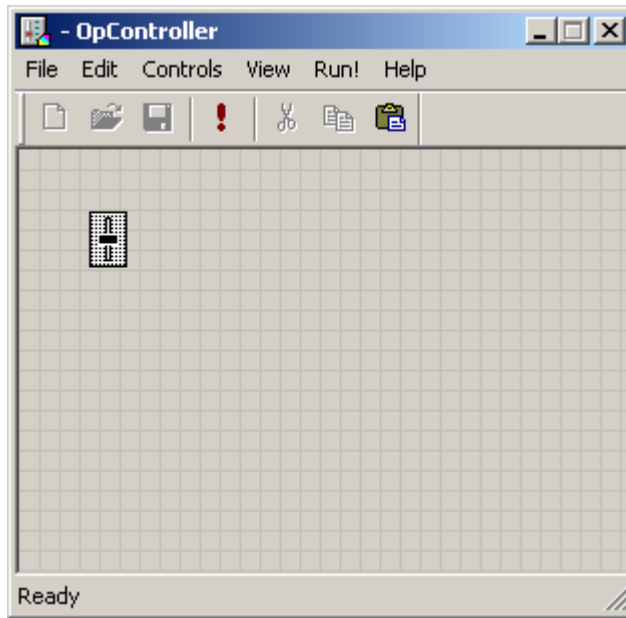

4. Click the grid to position the control.

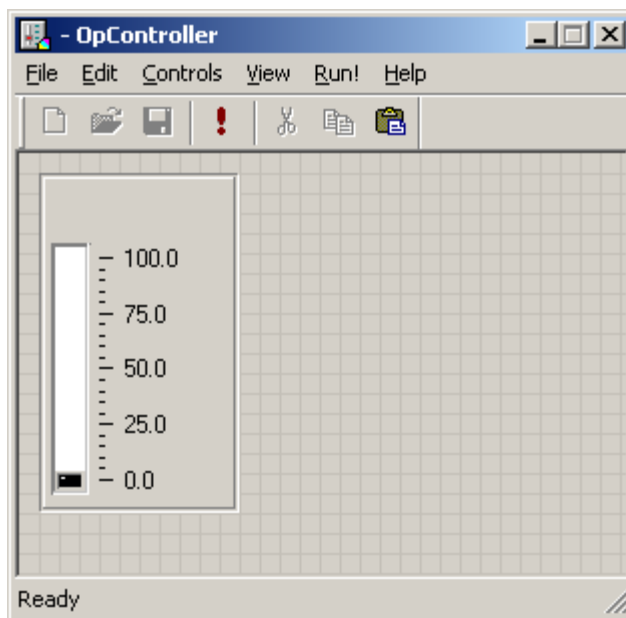

5. Double click the Slider Control to display the **properties dialog** box.
6. In the **Primary Target** box select the parameter tag to which the slider value will be sent. In the example below a parameter tag associated with a filter setting on the acq device was selected. The target can be typed or selected using the **Select Target** dialog box.

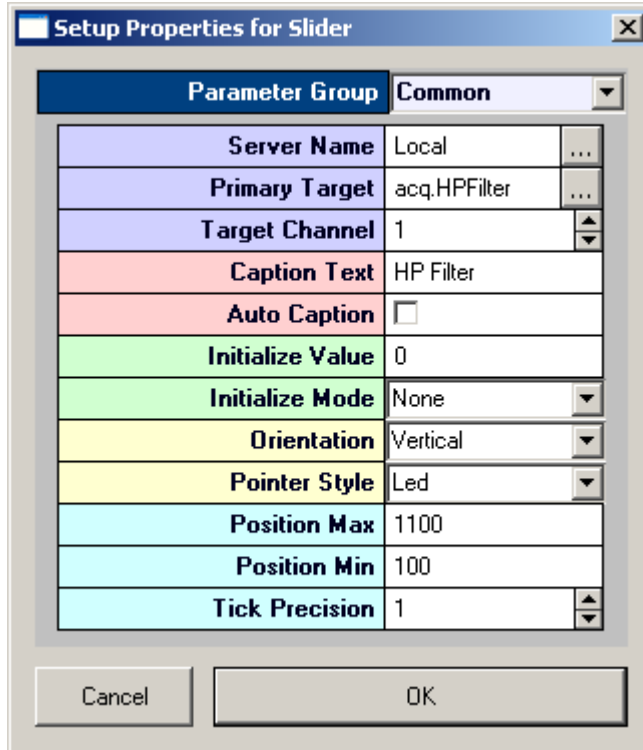

7. Modify any other settings as needed. In this example a caption HP Filter has also been added and the **Auto Caption** check box has been cleared so that the used defined caption will be used. The Position Max and Min were modified to match the correct range for the high pass filter.
8. Click **OK**.

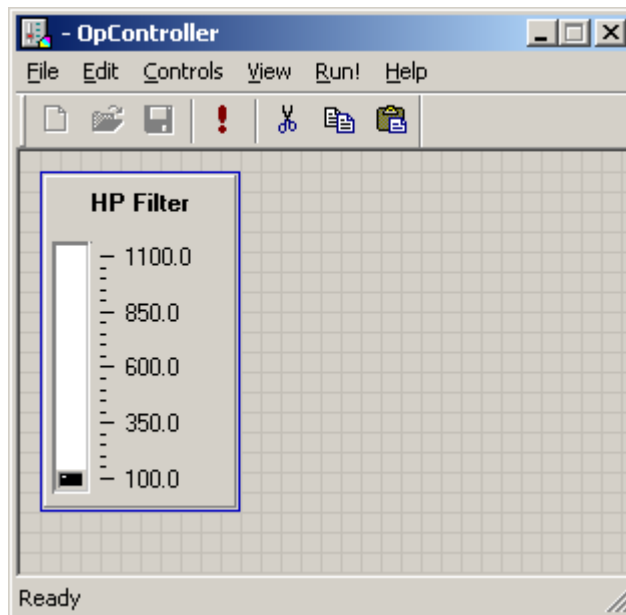

9. To add a 7 segment display, click the **Controls** menu, point to **Numeric Displays**, and click **7 Segment Display**.
10. Click the grid to position the control.

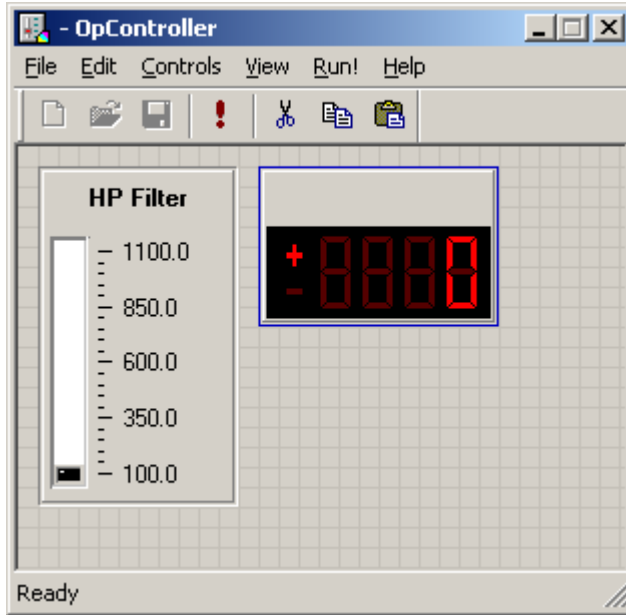

11. Double-click the control to display the **properties dialog** box.
12. In the **Source Target** box enter the source path. In this case the Source Target is the Value setting found in the Value Control parameter group settings for the control named **cSlider-3**. The source target can be entered using the **Select Target** dialog box or by typing a greater than sign (>) followed by the source path. If the Select Target dialog box is used the greater than sign is added automatically.

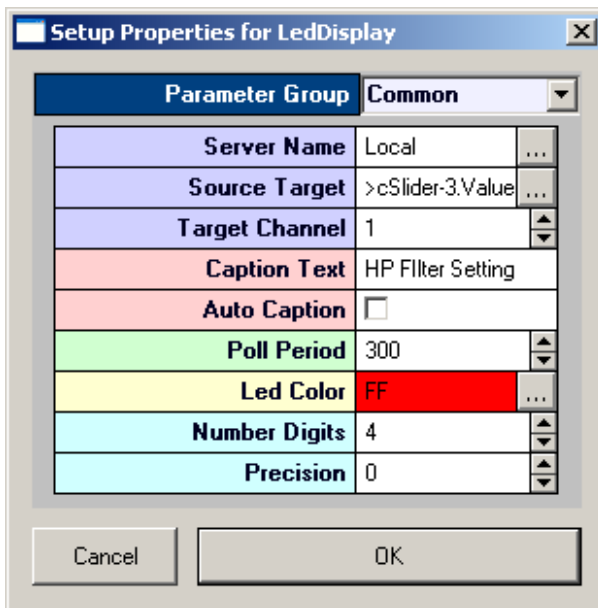

13. Modify any other settings as needed. In this example, the **Caption Text** setting has been changed to **HP Filter Setting** and the **Auto Caption** check box has been cleared.
14. Click **OK**.
15. Click **Record** or **Preview** in the OpenWorkbench System Controls.
16. Click the  **Toggle Mode** button on the OpenController toolbar. The control set is run and active. Moving the slider will now change both the filter setting on the Device and the value in the 7 segment display.

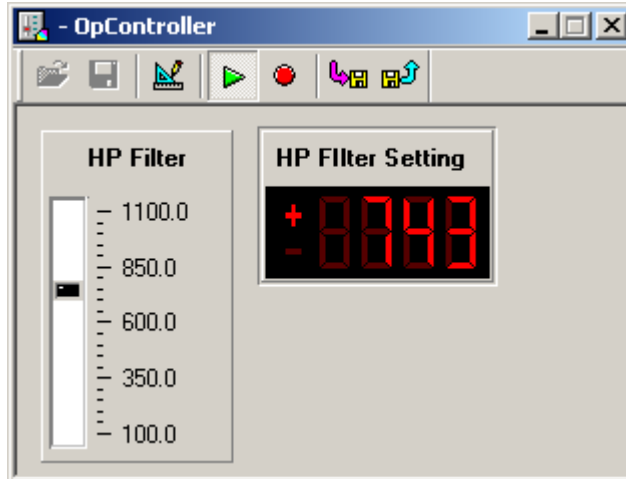

Control Settings Reference

About the Control Settings Reference

In the Control Settings Reference, each topic corresponds to a parameter group in the properties dialog box.

How Topics Are Arranged

Some settings, such as the settings in the Captions/Borders parameter group, are the same for each control that includes these settings. Other settings vary by control. When settings in a parameter group vary by control, the topics for each control type have been arranged in a folder for that parameter group. Within each folder topics are arranged alphabetically.

How To Find These Settings

Settings in this reference are available in the properties dialog boxes.

To open the properties dialog box for a control, double-click the control in the grid area of OpenController's Design mode.

Caption/Border Parameter Group

Caption Text: Type text for a caption if desired. The Auto Caption check box must be cleared for the caption text to be used. The Caption Visible check box must also be selected.

Caption Align: Select an alignment for the control title.

Caption Color: Select a color for the caption from a color palette.

Caption Visible: Select the check box to set the control title area to be visible. Clear the check box to hide the control title area.

Caption Bevel Visible: Select the check box to give the control title area a beveled appearance.

Auto Caption: When the Auto Caption check box is selected, a caption will be automatically generated and applied to the control. The auto caption is based on the target value. Clear the Auto Caption check box to use a caption defined in the Caption Text box.

Border Style: Select an appearance style for the border.

Border Color: Select a color for the border from a color palette.

Channel Selector Parameter Group

Channel Selector Visible: Select the check box to display a channel selector as part of the control. The channel selector is a slider that can be used to control which channel of data is used to animate a single view plot.

Channel Selector Positions: Enter the number of positions to appear on the channel selector.

Channel Selector Offset: Enter the number to offset the position values. For example, enter 2 to begin position values with channel 3.

Colors Parameter Group

Category Coloring: Set how the trace colors will be applied.

None: The color set in the Trace Color value box will be applied to all traces.

By Channel: The color of traces will be automatically assigned by channel.

By Sortcode: The color of traces will be automatically assigned by sortcode.

Trace (or Dot) Color: Select the trace (or dot) color from a color palette. This selected color is only used if Category Coloring is set to None.

Plot Border Color: Select the plot border color from a color palette.

Foreground Color: Select the foreground color from a color palette.

Background Color: Select the trace color from a color palette.

Font Color: Select the font color from a color palette.

MultiChannel Grid Color: Select the multi-channel grid color from a color palette.

Data/Source Setup Parameter Group

The settings in this parameter group are automatically set when the Data target is a Store. The settings should only be modified when the Data Target is a buffer read directly from a hardware device (not a Store).

Shared Sync: Enabled when a Store acquires data from multiple channels/sources. A sync indicates the position of data in a buffer or when a change in data has occurred (these usually generate a logical high).

Plotting Mode: Choices include Tracked and Static. The Plotting Mode affects how plot data is updated. When Tracked is selected new data is displayed only when changes occur in OpenWorkbench. Static displays data based on the polling rate of the control without regard to whether new data has been acquired.

Filter Specification Parameter Group

Filter Frequency: This setting always reflects the current filter value and can be used as the target of another control, allowing the filter frequency to be modified by another control, such as a slider.

Default Filter Frequency: Enter the default filter frequency to be used if the initialize mode is Init On Run or Init On Load.

Initialize Mode: Select a mode from the drop down list. The available choices are: None, Init On Run or Init On Load.

Filter Type: Select the filter type from a drop down list. Choices are: Lowpass, Highpass, Bandpass, and Notch.

Bandwidth: Select the bandwidth of the filter in octaves. This setting is used only if the Filter Type is set to Bandpass.

Filtering Parameter Group

Filter On: Select the check box to enable a filter algorithm using FIR parameters provided in CoefB0-B4. Clear the check box to disable the filter.

CoefB0: Type a coefficient.

CoefB1: Type a coefficient.

CoefB2: Type a coefficient.

CoefB3: Type a coefficient.

CoefB4: Type a coefficient.

Margins Parameter Group

Left Margin: Type a value for the left margin of the plot.

Right Margin: Type a value for the right margin of the plot.

Top Margin: Type a value for the top margin of the plot.

Bottom Margin: Type a value for the bottom margin of the plot.

Multi View Parameter Group

Multi View Enabled: Select the check box to view each channel, or sort code, of data in an individual plot.

Num Views: Set the number of channels or sorts to view in a multi-view plot. If data contains more than 16 channels or sorts the value must be increased to show all data.

Num Columns: Set the number of columns in which multi-view plots are arranged.

View By: Channel or Sort Code. Sort Codes are generated in the RPvdsEx circuit.

View Index Offset: Starting channel or sort is the View Index Offset value +1.

For example: To begin viewing data with channel 3, set the View Index Offset value at 2.

Show View Index: Index is Channel or Sort Code and is determined by the View By value.

Pointer Parameter Group

Pointer Style: Select the pointer style from a drop down list. Choices are: Arrow-Line, Arrow, Line, and Triangle.

Pointer Color: Select the pointer color from a color palette.

Pointer Size: Enter the desired size of the pointer in pixels.

Pointer Margin: Enter the desired size of the margin between the tip of the pointer and the arc (that is, the tick marks along the arc).

Hub Visible: Select the check box to display a hub, or pinion point marker, at the base of the pointer. If the Hub Visible check box is selected, the hub Size can be specified.

Hub Size: Enter the desired size of the hub in pixels.

Hub Color: Select the desired color for the hub from a color palette.

Refresh Control Parameter Group

Refresh Period: Set a time value for the refresh period in seconds.

Scaling Parameter Group

X-Axis Range: The range of the x-axis.

Y-Axis Symmetry: Select the check box to ensure that a symmetrical Y-axis range will be displayed. This is ideal for signals that are expected to be symmetrical.

Auto Scale: The plot can be set to automatically scale during animation to ensure that the data can always be viewed in a convenient scale.

None: Auto Scale is turned off.

Active: The scale of the plot is automatically adjusted to ensure all values can be shown on the plot.

Smart: The scale of the plot is automatically adjusted to ensure values can be shown on the plot only during the first 3 seconds.

Up-Scale Hist.: When Auto Scale is used, this value sets the number of points above the Y-axis range that the signal must reach before scaling will occur.

Down-Scale Hist.: When Auto Scale is used, this value sets the number of points below half of the Y-axis range a signal must fall before scaling will occur.

SigGen Specs Parameter Group

SigGen File: Select the SigGen file to use with the SigGen control.

Maximum SGI: Enter the desired maximum SGI.

Minimum SGI: Enter the desired minimum SGI.

Switch Positions Parameter Group

Position Labels: Enter the labels to appear for each switch position, separated by a comma.

Position Values: Enter the value for each switch position, separated by a comma.

Key Arrow Step Size: Enter the number of positions to move when pressing the UP ARROW or DOWN ARROW keys on the keyboard.

Key Page Step Size: Enter the number of positions to move when pressing the PAGE UP or PAGE DOWN keys on the keyboard.

Sections Parameter Group

Section Count: Enter the desired number of section for the arc. Up to five sections can be defined and distinguished by color.

Section Color 1: Select a color for the first section. If the Section Count equals 1, then the Section Color 1 will be applied to the entire arc. If the Section Count is greater than 1 then Section End 1 must be defined before the color can be applied.

Section Color 2: Select a color for the second section. The Section Count must be greater than or equal to 2 and the section ends should be defined.

Section Color 3: Select a color for the third section. The Section Count must be greater than or equal to 3 and the section ends should be defined.

Section Color 4: Select a color for the fourth section. The Section Count must be greater than or equal to 2 and the section ends should be defined.

Section Color 5: Select a color for the fifth section. The Section Count must be greater than or equal to 2 and the section ends should be defined.

Section End 1: Enter the value in degrees for the first section's end point along the arc. The Section Count must be greater than or equal to 1.

Section End 2: Enter the value in degrees for the second section's end point along the arc. The Section Count must be greater than or equal to 2.

Section End 3: Enter the value in degrees for the third section's end point along the arc. The Section Count must be greater than or equal to 3.

Section End 4: Enter the value in degrees for the fourth section's end point along the arc. The Section Count must be greater than or equal to 4.

Setup Default Properties Parameter Group

Grid Size: Select the number of pixels for each square in the design grid.

Page Color: Select the design page color.

Save/Load State: Specify the behavior for saving and loading controller states.

Multiple Files: Check to enable multiple controller state file saving and loading.

Auto Run on Load: Check to force controller into Run! Mode on load.

Default Server Name: Specify the default server name for the current controller file.

Master Channel: Specify the master channel.

Master SortCode: Not yet implemented.

Master Device: Not yet implemented.

X-Axis Setup Parameter Group

Show X Labels: Select the check box to display a unit label for the x-axis. Clear the check box to hide the x-axis label.

X-Axis Unit: Set name for units that will appear as part of the plot label.

X-Axis Units Factor: Define a multiplication factor to convert x-axis units to valid value for units label.

X-Axis Offset: Define the starting value for the x-axis.

Y-Axis Setup Parameter Group

Show Y Labels: Select the check box to display a unit label for the y-axis. Clear the check box to hide the y-axis label.

Y-Axis Units: Set name for units that will appear as part of the plot label.

Y-Axis Units Factor: Define a multiplication factor to convert y-axis units to valid value for units label.

Appearance Parameter Group

7 Segment Display Appearance Parameters

LED Color: Select a color for the segments of the numeric display from a color palette.

Background Color: Select a color for the background of the numeric display from a color palette.

Show Off Segments: Select the check box to display shadow images of segments that are not in use.



Show Off Segments check box selected.

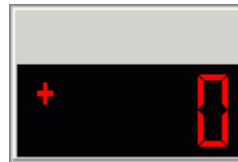

Show Off Segments check box cleared.

Input Box Appearance Parameters

Alignment: Select an alignment type for value and units text to determine the position of text within the control's display window. Choices are Center, Left, and Right.

Font Color: Select a color value and units text from a color palette.

Background Color: Select a background color from a color palette.

Max Length: Type a value to set the maximum number of characters that can be input.

Units Text: Enter the unit's text to be added to the display.

Undo On Error: When the check box is selected the control will automatically clear input errors.

Knob Appearance Parameters

Knob Style: Select a knob style. Choices are Raised Edge, Raised, Sunken, and Sunken Edge.

Edge Width: Select a value to adjust the edge width.

Indicator Style: Select an indicator style. Choices are Dot Lowered, Dot Raised, Dot, Line Center, Line Custom, and Triangle.

Indicator Size: Select a value to adjust the Indicator size.

Indicator Margin: Select a value to adjust the Indicator margin.

Led Caption/Indicator Appearance Parameters

Led Color: Select a color for the led from a color palette.

Led Bevel Style: Select a bevel style to control the three dimensional appearance of the control. Choices are None, Raised, and Lowered.

Threshold: Type the threshold. If the value change is greater than the threshold, the indicator will be toggled off or on.

Plots/Graphs Appearance Parameters

Plot Title: Type a title for the plot.

Plot Auto Title: When the check box is selected the plot will have an auto generated plot title.

Plot Title Position: Select a position for the plot title.

Plot Line Width: Select a numerical value for the plot line width.

Plot Font Size: Select a numerical value for the plot font size.

Show MultiChannel Grid: When the check box is selected the plot will display lines separating channels when the multi channel view option is enabled.

Highlight Top Trace: When the check box is selected the plot will highlight the most recent event displayed.

Plot Type: Select between line and dotted plot types.

Setup Appearance Parameters

Grid Size: Select the number of pixels for each square in the design grid.

Page Color: Select the design page color.

Grid Color: Select the grid color.

Highlight Color: Select the color used for highlighting.

Slider Appearance Parameters

Orientation: Select the orientation of the slider movement. Choices are Vertical and Horizontal.

Ends Margin: Select a value to adjust the margins from the top and bottom ends of the control.

Pointer Style: Select the display style of the slider pointer. Choices are Led, Pointer, Bar, and Light Bar.

Pointer Height: Select a value to adjust the pointer height.

Pointer Width: Select a value to adjust the pointer width.

Pointer Color: Select a color value from a color palette for the pointer.

Track Style: Select display styles for the slide switch track. Choices are Box, Line, Bevel Raised, and Bevel Lowered.

Major Tick Style: Select a style for the major tick. Choices are None, Raised, and Lowered.

Minor Tick Style: Select a style for the minor tick. Choices are None, Raised, and Lowered.

Major Tick Length: Select a value for the major tick length.

Minor Tick Length: Select a value for the minor tick length.

Tick Margin: Type a value to adjust the tick margin left or right.

Slide Switch Appearance Parameters

Pointer Style: Select display types for the slide switch pointer. Choices are Led, Pointer, Bar, Light Bar.

Pointer Led Color: Select a color value from a color palette for the pointer led.

Pointer Height: Select a value to adjust the pointer height.

Pointer Width: Select a value to adjust the pointer width.

Track Style: Select display styles for the slide switch track. Choices are Box, Line, Bevel Raised, Bevel Lowered.

Indicators Visible: When the check box is selected indicators on the slide switch are visible.

Indicator Size: Select a value to adjust the Indicator size.

Indicator Color: Select a color value from a color palette for the Indicator color.

Switch/Momentary Button Appearance Parameters

Button Text Font Color: Select a color value for the button text from a color palette.

Auto Led Size: When the check box is selected the button's LED graphic will adjust to the size of the button.

Button Text: Type text for the button display name.

Button Text Alignment: Select an alignment type for text to determine the position of the button text. Choices are Top and Bottom.

Button Text Margin: Select a value to adjust the button text margin.

Indicator Alignment: Select an alignment type for the LED indicator to determine its position. Choices are Top and Bottom, Left, Top, and Right

Indicator Height: Select a value to adjust the LED indicator height.

Indicator Margin: Select a value to adjust the LED indicator margin.

Indicator Width: Select a value to adjust the LED indicator width.

Value Watch Appearance Parameters

Font Color: Select a color value for the font from a color palette.

Background Color: Select a background color from a color palette.

Units Text: Enter the unit's text to be added to the display.

Text Alignment: Select an alignment type for value and units text to determine the position of text within the control's display window. Choices are Center, Left, and Right.

Inner Border Style: Select a bevel style to control the three dimensional appearance of interior borders of the control. Choices are None, Raised, and Lowered.

Precision: Enter the number of digits to be displayed after the decimal point. The precision value should be less than the Number Digits value to display the desired precision.

Behavior Parameter Group

Chart Plot Behavior Parameters

Time Span: Set the time range, in seconds and according to the time stamp, to be displayed on the X-axis.

Data Table Behavior Parameters

Ordering Scheme: Select an ordering scheme. Choices are Manual, Sequential, Random, and Sync Tag.

Manual: ordering controlled by clicking row numbers.

Sequential: if no rows are selected then all rows will be sent sequentially. If rows are selected then, selected rows will be sent sequentially.

Random: if no rows are selected then all rows will be sent randomly. If rows are selected then, selected rows will be sent randomly until all selected rows and repeats are done.

Sync Tag: the value of the synchronization target controls which row is sent. For example, if the sync tag equals one then the first data row (row six) will be sent.

Synchronization Type: Select a synchronization type. Choices are None, On Tag Change, and On Tag True.

None: no synchronization, rows are sent one after another till done

On Tag Change: the table will be synchronized with the synchronization target and values are sent whenever the synchronization target changes.

On Tag True: the table will be synchronized with the synchronization target and values will be sent whenever the synchronization target value equals true.

Synchronization Target: Select a target to which the data table will be synchronized. Click the lookup button  to open the Select Target dialog box.

Stop Controller: When the check box is selected the control set will be stopped when all table entries have been sent.

Feature Plot Behavior Parameters

Cloud Points: Set the minimum number of points to display. The maximum number of cloud points will be twice the value set. The plot will refresh when the maximum number is reached.

X-Axis Feature: Select from a drop down list. Choices are Total Amplitude, Peak 1, Peak 2, Peak to Peak Time, and Area.

Y-Axis Feature: Select from a drop down list. Choices are Total Amplitude, Peak 1, Peak 2, Peak to Peak Time, and Area.

Input Box Behavior Parameters

Precision: Enter the number of digits displayed after the decimal point in the numeric display.

Value Max: Enter the desired maximum value. If the actual input value is greater than the defined maximum, the maximum value will be used.

Value Min: Enter the desired minimum value. If the actual input value is less than the defined minimum, the minimum value will be used.

Master Mode Behavior Parameters

Mode on Run: Select the OpenWorkbench System Control Mode to enable when the OpenController settings in window containing this control are Run. Choices are None, Standby, Preview, and Run.

Mode on Stop: Select the OpenWorkbench System Control Mode to enable when the OpenController settings in window containing this control are set to Stop. Choices are None, Idle, and Standby.

Delay to run (secs): Enter a value in seconds to delay implementation of Mode on Run setting.

Delay to stop (secs): Enter a value in seconds to delay implementation of Mode on Stop setting.

Momentary Button Behavior Parameters

Value when On: Type value when on.

Value when Off: Type value when off.

Value in milliseconds for On time: Type the length of time for the control to stay on when clicked.

Scope/Pile Plot Behavior Parameters

Pile Depth: Set the number of traces that will be displayed. Set the Pile Depth to 1 to create a scope plot.

Scrolling Plot Behavior Parameters

Scroll Sections: Set the number of sections to display before scrolling.

Scrolling Threshold Behavior Parameters

Threshold Target: The threshold target is used to set the lower threshold for the ae~1parameter tag attached to a spike sorting component.

Threshold Scaling Factor: Enter a voltage value to scale the threshold target to match the voltage range of the signal being sent to the spike sorting component. This is usually the inverse of the "scale factor" parameter in a PlotDec16, CompTo16, or CompTo8 RPvdsEx component that was used to compress the data before display. For example: If the scale factor of a PlotDec16 is set to

10^6 to convert it to microvolts, then the Threshold Scaling Factor should be set to 10^6 . If the scale factor of a CompTo16 is set to 32767, then the Threshold Scaling Factor should be set to 3.052×10^{-5} .

Sort/Thresh Mark Persistence: Select Dynamic or Saved to determine if the threshold is saved when the control is stopped. Select dynamic to update the threshold each time the control is run. Select Saved to use the fixed threshold until Auto-Threshold is run or the scaling is changed manually.

Auto-Threshold S/N Factor: Select a choice from the drop down menu to determine the signal to noise factor that will be used to set the threshold when the auto-threshold feature is used. Auto sets the threshold based on any spike activity that is above the noise floor. Even if no spikes occur the control will calculate a threshold that will acquire some signals above the threshold. 2-1 through 5-1 selects a fixed ratio that generates a threshold that is x times greater than the noise floor.

Auto-Threshold Effort: Select low, medium, or high to determine how large a data block will be acquired before the threshold is calculated. High uses the largest block (taking the longest time) and small uses the smallest block (to calculate the threshold the quickest).

Auto-Threshold Polarity: Select Either, Positive Only, or Negative Only to determine if the threshold will look for positive going signals, negative signals, or signals in either direction. A fixed polarity can be used to separate different waveforms.

Scroll Sections: Selects the number of scroll sections to display.

Setup Behavior Parameters

Save/Load State: Specify the behavior for saving and loading controller states.

Multiple Files: Check to enable multiple controller state file saving and loading.

Auto Run on Load: Check to force controller into Run! Mode on load.

Disable Run Button: Check to disable the Run button.

Disable Stop Button: Check to disable the Stop button.

Default Server Name: Specify the default server name for the current controller file.

Lock on Stop: Check to lock controller when the stop button is pressed.

Slider Behavior Parameters

Key Arrow Step Size: Enter a step size for slider movements when using the arrow keys on the keyboard to control the slider.

Key Page Step Size: Enter a step size for slider movements when using the Page Up and Page Down keys on the keyboard to control the slider.

Snippet Sort Behavior Parameters

Sort/Thresh Mark Persistence: Select Dynamic or Saved to determine if the threshold and sort values are saved when the control is stopped. Select dynamic to reset the threshold and sort values each time the control is run. Select Saved to retain the settings until the settings are changed manually or using the auto-sort feature.

Training Sample Size: Enter a value to determine the maximum number of samples used to sort spikes. Using more spikes (an increased sample size) allows individual units to be separated more effectively and rare units are more likely to be detected. However, if unit activity is low using a large sample size can take an inordinately long time.

Maximum Training Time: Enter a value in seconds to set an upper limit on the auto-sort process. If the training sample size is not reached in the maximum training time, the sort is based on the existing sample size.

Allow Unsorted Group: Select the check box to allow unsorted spikes.

Pile Depth: Set the number of traces that will be displayed.

Switch Button Behavior Parameters

Value when On: Type value when on.

Value when Off: Type value when off.

Shared Behavior Parameters

Hidden When Running: When the controls are run, the editor will be hidden from view.

Common Parameter Group

7 Segment Display Common Parameters

Server Name: Select the server name. The default value **Local** selects the local server.

Source Target: Select or type the name of the source target. When an OpenWorkbench configuration is open, available targets can be selected using the Select Target dialog box. Click the look-up button  to open the Select Target dialog box. Using the Select Target dialog boxes ensures valid formatting of target name.

The source target should be either the Store name (from the OpenWorkbench file) or the device name (from the OpenWorkbench file) followed by the parameter tag (from the RPsVsEx circuit). This should follow the form "ssss" for Store name or "dddd.partag" for device name and parameter tag.

When linking controls together, the target will be a greater than symbol followed by the source control's My Name value followed by the setting name. This should follow the form "myname.settingname" e.g. ">FreqSlider.Value Shift"

Target Channel: Enter the channel number.

Caption Text: Type text for a caption if desired. The Auto Caption check box must be cleared for the caption text to be used. The Caption Visible check box, in the Caption/Borders parameter group must also be selected. The Caption Visible check box is selected by default for the 7 segment display.

Auto Caption: When the Auto Caption check box is selected, a caption will be automatically generated and applied to the control. The auto caption is based on the source target value. Clear the Auto Caption check box to use a caption defined in the Caption Text box.

Poll Period: Enter a value in milliseconds to set the poll period. The poll period is a defined interval at which OpenController accesses control targets.

Led Color: Select a color for the segments of the numeric display from a color palette.

Number Digits: Enter the number of digits to be displayed. By default, the leading unused digits will be displayed as spaces. The total number of digits should be sufficient to display the desired precision.

Precision: Enter the number of digits to be displayed after the decimal point. The precision value should be less than the Number Digits value to display the desired precision.

Biquad Coefficient Generator Common Parameters

Server Name: Select the server name. The default value of **Local** selects the local server.

Coef Target: Select the parameter tag associated with the >Coef line in the Biquad component.

Delay Line Target: Select the parameter tag associated with the >Delay line.

Target Channel: Enter the channel number.

Caption Text: Type text for a caption if desired. The Auto Caption check box must be cleared for the caption text to be used. The Caption Visible check box, in the Caption/Borders parameter group must also be selected.

Auto Caption: When the Auto Caption check box is selected, a caption will be automatically generated and applied to the control. The auto caption is based on the coef target value. Clear the Auto Caption check box to use a caption defined in the Caption Text box.

Default Filter Frequency: Enter the default filter frequency to be used if the initialize mode is Init On Run or Init On Load.

Initialize Mode: Select a mode from the drop down list. The available choices are: None, Init On Run or Init On Load.

Filter Type: Select the filter type from a drop down list. Choices are: Lowpass, Highpass, Bandpass, and Notch.

Bandwidth: Select the bandwidth of the filter in octaves. This setting is used only if the Filter Type is set to Bandpass.

Chart Plot Common Parameters

Server Name: Select the server name. The default value of **Local** selects the local server.

Source Target: Select the data event (Store name) to be plotted.

Target Channel: Selects the channel for viewing. To view a single channel of data enter the desired channel number.

Caption Text: Type caption text to display on the plot. The Auto Caption check box must be cleared before caption text will be used.

Auto Caption: Select the check box to display an automatically generated caption for the plot. The auto caption is generated using the Store name. Clear the check box to hide the auto caption. The auto caption should be hidden if no caption is desired or if a user-defined caption should be used.

Poll Period: Enter a value in milliseconds to set the poll period. The poll period is a defined interval at which OpenController accesses control targets.

Channel Selector Visible: Select the check box to display a channel selector as part of the control. The channel selector is a slider that can be used to control which channel of data is used to animate a single view plot. By default the channel selector options include channels one through eight. The user can modify the number of channels or offset value in the Channel Selector parameter group.

Time Span: Set the time range, in seconds and according to the time stamp, to be displayed on the X-axis.

Multi View Enabled: Select the check box to view each channel, or sort code, of data in an individual plot.

Num Views: Select the number of channels or sort codes to view. By default, channels will be displayed beginning with channel 1.

Num Columns: Select the number of columns to display.

Category Coloring: Selects the trace coloring method. Traces can be seen in a single color (None), one color per channel (By Channel), or one color per sort code (By SortCode).

Data Table Common Parameters

Server Name: Select the server name. The default value of **Local** selects the local server.

Caption Text: Type caption text to display on the control. The Auto Caption check box must be cleared before caption text will be used.

Auto Caption: Clear the check box to use a user-defined caption.

Ordering Scheme: Select an ordering scheme. Choices are Manual, Sequential, Random, and Sync Tag.

Manual: ordering controlled by clicking row numbers.

Sequential: if no rows are selected then all rows will be sent sequentially. If rows are selected then, selected rows will be sent sequentially.

Random: if no rows are selected then all rows will be sent randomly. If rows are selected then, selected rows will be sent randomly until all selected rows and repeats are done.

Sync Tag: the value of the synchronization target controls which row is sent. For example, if the sync tag equals one then the first data row (row six) will be sent.

Synchronization Type: Select a synchronization type. Choices are None, On Tag Change, and On Tag True.

None: no synchronization, rows are sent one after another till done

On Tag Change: the table will be synchronized with the synchronization target and values are sent whenever the synchronization target changes.

On Tag True: the table will be synchronized with the synchronization target and values will be sent whenever the synchronization target value equals true.

Synchronization Target: Select a target to which the data table will be synchronized. Click the lookup button  to open the Select Target dialog box.

Feature Plot Common Parameters

Server Name: Select the server name. The default value of **Local** selects the local server.

Source Target: Select the data event (Store name) to be plotted.

Target Channel: Selects the channel for viewing. To view a single channel of data enter the desired channel number.

Caption Text: Type caption text to display on the plot. The Auto Caption check box must be cleared before caption text will be used.

Auto Caption: Select the check box to display an automatically generated caption for the plot. The auto caption is generated using the Store name. Clear the check box to hide the auto caption. The auto caption should be hidden if no caption is desired or if a user-defined caption should be used.

Poll Period: Enter a value in milliseconds to set the poll period. The poll period is a defined interval at which OpenController accesses control targets.

Channel Selector Visible: Select the check box to display a channel selector as part of the control. The channel selector is a slider that can be used to control which channel of data is used to animate a single view plot. By default the channel selector options include channels one through eight. The user can modify the number of channels or offset value in the Channel Selector parameter group.

Cloud Points: Set the minimum number of points to display. The maximum number of cloud points will be twice the value set. The plot will refresh when the maximum number is reached.

X-Axis Feature: Select from a drop down list. Choices are Total Amplitude, Peak 1, Peak 2, Peak to Peak Time, and Area.

Y-Axis Feature: Select from a drop down list. Choices are Total Amplitude, Peak 1, Peak 2, Peak to Peak Time, and Area.

Multi View Enabled: Select the check box to view each channel, or sort code, of data in an individual plot.

Num Views: Select the number of channels or sort codes to view. By default, channels will be displayed beginning with channel 1.

Num Columns: Select the number of columns to display.

Category Coloring: Selects the trace coloring method. Traces can be seen in a single color (None), one color per channel (By Channel), or one color per sort code (By SortCode).

Input Box Common Parameters

Server Name: Select the server name. The default value of **Local** selects the local server.

Primary Target: Select or type the name of the primary destination target. When an OpenWorkbench configuration is open, available targets can be selected using the Select Target dialog box. Click the look-up button  to open the Select Target dialog box. Using the Select Target dialog boxes ensures valid formatting of target name.

The target should generally be the device name (from the OpenWorkbench file) followed by the parameter tag (from the RPvdsEx circuit). This should follow the form "dddd.parTag" for device name and parameter tag.

When linking controls together, and the target is the source, the target name will be a greater than symbol followed by the source control's My Name value followed by the setting name. This should follow the form "myname.settingname" e.g. ">FreqSlider.Value Shift"

When the target is the destination, the target name will be a lesser than symbol followed by the source control's My Name value followed by the setting name. This should follow the form "myname.settingname" e.g. "<FreqSlider.Value Shift"

Target Channel: Enter the channel number.

Caption Text: Type text for a caption if desired. The Auto Caption check box must be cleared for the caption text to be used. The Caption Visible check box, in the Caption/Borders parameter group must also be selected. The Caption Visible check box is selected by default for the input box.

Auto Caption: When the Auto Caption check box is selected, a caption will be automatically generated and applied to the control. The auto caption is based on the target value. Clear the Auto Caption check box to use a caption defined in the Caption Text box.

Initialize Value: Type a value to be used as an initial value if the initialize mode is set to Init On Run or Init On Load.

Initialize Mode: Select a mode from the drop down list. The available choices are: None, Init On Run or Init On Load.

Units Text: Type text to be added to the value as an indication of units for the value.

Knob Common Parameters

Server Name: Select the server name. The default value of **Local** selects the local server.

Primary Target: Select or type the name of the primary destination target. When an OpenWorkbench configuration is open, available targets can be selected using the Select Target dialog box. Click the look-up button  to open the Select Target dialog box. Using the Select Target dialog boxes ensures valid formatting of target name.

The target should generally be the device name (from the OpenWorkbench file) followed by the parameter tag (from the RPvdsEx circuit). This should follow the form "dddd.parTag" for device name and parameter tag.

When linking controls together, and the target is the source, the target name will be a greater than symbol followed by the source control's My Name value followed by the setting name. This should follow the form "myname.settingname" e.g. ">FreqSlider.Value Shift".

When the target is the destination, the target name will be a lesser than symbol followed by the source control's My Name value followed by the setting name. This should follow the form "myname.settingname" e.g. "<FreqSlider.Value Shift".

Target Channel: Enter the channel number.

Caption Text: Type text for a caption if desired. The Auto Caption check box must be cleared for the caption text to be used. The Caption Visible check box, in the Caption/Borders parameter group must also be selected. The Caption Visible check box is selected by default for the knob.

Auto Caption: When the Auto Caption check box is selected, a caption will be automatically generated and applied to the control. The auto caption is based on the target value. Clear the Auto Caption check box to use a caption defined in the Caption Text box.

Initialize Value: Type a value to be used as an initial value if the initialize mode is set to Init On Run or Init On Load.

Initialize Mode: Select a mode from the drop down list. The available choices are: None, Init On Run or Init On Load.

Position Display Visible: When the Position Display Visible check box is selected the current position value is displayed at the center of the knob.

Scale Max: Enter the maximum value to be displayed for the knob.

Scale Min: Enter the minimum value to be displayed for the knob.

Label Precision: Enter the number of digits to be displayed after the decimal point for value labels on the knob.

Led Caption Common Parameters

Server Name: Select the server name. The default value of **Local** selects the local server.

Source Target: Select or type the name of the source target. When an OpenWorkbench configuration is open, available targets can be selected using the Select Target dialog box. Click the look-up button  to open the Select Target dialog box. Using the Select Target dialog boxes ensures valid formatting of target name.

The source target should be either the Store name (from the OpenWorkbench file) or the device name (from the OpenWorkbench file) followed by the parameter tag (from the RPvdsEx circuit). This should follow the form "ssss" for Store name or "dddd.partag" for device name and parameter tag.

When linking controls together, the target will be a greater than symbol followed by the source control's My Name value followed by the setting name. This should follow the form "myname.settingname" e.g. ">FreqSlider.Value Shift".

Target Channel: Enter the channel number.

Caption Text: Type text for a caption if desired. The Auto Caption check box must be cleared for the caption text to be used. The Caption Visible check box, in the Caption/Borders parameter group must also be selected. The Caption Visible check box is selected by default for the led caption.

Auto Caption: When the Auto Caption check box is selected, a caption will be automatically generated and applied to the control. The auto caption is based on the source target value. Clear the Auto Caption check box to use a caption defined in the Caption Text box. The Caption Visible check box, in the Caption/Borders parameter group must also be selected.

Poll Period: Enter a value in milliseconds to set the poll period. The poll period is a defined interval at which OpenController accesses control targets.

Led Color: Select a color for the led from a color palette.

On/Off Threshold: Type the threshold. If the value change is greater than the threshold, the indicator will be toggled off or on.

Led Indicator Common Parameters

Server Name: Select the server name. The default value of **Local** selects the local server.

Source Target: Select or type the name of the source target. When an OpenWorkbench configuration is open, available targets can be selected using the Select Target dialog box. Click the look-up button  to open the Select Target dialog box. Using the Select Target dialog boxes ensures valid formatting of target name.

The source target should be either the Store name (from the OpenWorkbench file) or the device name (from the OpenWorkbench file) followed by the parameter tag (from the RPvdsEx circuit). This should follow the form "ssss" for Store name or "dddd.partag" for device name and parameter tag.

When linking controls together, the target will be a greater than symbol followed by the source control's My Name value followed by the setting name. This should follow the form "myname.settingname" e.g. ">FreqSlider.Value Shift".

Target Channel: Enter the channel number.

Caption Text: Type text for a caption if desired. The Auto Caption check box must be cleared for the caption text to be used.

The Caption Visible check box, in the Caption/Borders parameter group must also be selected. The Caption Visible check box is selected by default for the led indicator.

Auto Caption: When the Auto Caption check box is selected, a caption will be automatically generated and applied to the control. The auto caption is based on the source target value. Clear the Auto Caption check box to use a caption defined in the Caption Text box.

Poll Period: Enter a value in milliseconds to set the poll period. The poll period is a defined interval at which OpenController accesses control targets.

Led Color: Select a color for the led from a color palette.

On/Off Threshold: Type the threshold. If the value change is greater than the threshold, the indicator will be toggled off or on.

Linear Gauge Common Parameters

Server Name: Select the server name. The default value of **Local** selects the local server.

Source Target: Select or type the name of the source target. When an OpenWorkbench configuration is open, available targets can be selected using the Select Target dialog box. Click the look-up button  to open the Select Target dialog box. Using the Select Target dialog boxes ensures valid formatting of target name.

The source target should be either the Store name (from the OpenWorkbench file) or the device name (from the OpenWorkbench file) followed by the parameter tag (from the RPvdsEx circuit). This should follow the form "ssss" for Store name or "dddd.partag" for device name and parameter tag.

When linking controls together, the target will be a greater than symbol followed by the source control's My Name value followed by the setting name. This should follow the form "myname.settingname" e.g. ">FreqSlider.Value Shift".

Target Channel: Enter the channel number.

Caption Text: Type text for a caption if desired. The Auto Caption check box must be cleared for the caption text to be used. The Caption Visible check box, in the Caption/Borders parameter group must also be selected. The Caption Visible check box is selected by default for the linear gauge.

Auto Caption: When the Auto Caption check box is selected, a caption will be automatically generated and applied to the control. The auto caption is based on the source target value. Clear the Auto Caption check box to use a caption defined in the Caption Text box.

Poll Period: Enter a value in milliseconds to set the poll period. The poll period is a defined interval at which OpenController accesses control targets.

Arc Start: Enter the position in degrees for the starting position of the arc display.

Arc Range: Enter the range in degrees for the arc display. For example: 90 degrees for a quarter circle arc.

Scale Minimum: Enter the minimum value for gauge values that will be displayed.

Scale Maximum: Enter the maximum value for gauge values that will be displayed.

Label Precision: Enter the number of digits to be displayed after the decimal point for value labels found on the control.

Logarithmic Gauge Common Parameters

Server Name: Select the server name. The default value of **Local** selects the local server.

Source Target: Select or type the name of the source target. When an OpenWorkbench configuration is open, available targets can be selected using the Select Target dialog box. Click the look-up button  to open the Select Target dialog box. Using the Select Target dialog boxes ensures valid formatting of target name.

The source target should be either the Store name (from the OpenWorkbench file) or the device name (from the OpenWorkbench file) followed by the parameter tag (from the RPvdsEx circuit). This should follow the form "ssss" for Store name or "dddd.partag" for device name and parameter tag.

When linking controls together, the target will be a greater than symbol followed by the source control's My Name value followed by the setting name. This should follow the form "myname.settingname" e.g. ">FreqSlider.Value Shift".

Target Channel: Enter the channel number.

Caption Text: Type text for a caption if desired. The Auto Caption check box must be cleared for the caption text to be used. The Caption Visible check box, in the Caption/Borders parameter group must also be selected. The Caption Visible check box is selected by default for the logarithmic gauge.

Auto Caption: When the Auto Caption check box is selected, a caption will be automatically generated and applied to the control. The auto caption is based on the source target value. Clear the Auto Caption check box to use a caption defined in the Caption Text box.

Poll Period: Enter a value in milliseconds to set the poll period. The poll period is a defined interval at which OpenController accesses control targets.

Arc Start: Enter the position in degrees for the starting position of the arc display.

Arc Range: Enter the range in degrees for the arc display. For example: 90 degrees for a quarter circle arc.

Scale Minimum: Enter the minimum value for gauge values that will be displayed.

Scale Maximum: Enter the maximum value for gauge values that will be displayed.

Tick Label Precision: Enter the number of digits to be displayed after the decimal point for value labels found on the control.

Master Mode Common Parameters

Server Name: Select the server name. The default value of **Local** selects the local server.

Caption Text: Type text for a caption if desired. The Caption Visible check box, in the Caption/Borders parameter group must also be selected. The Caption Visible check box is selected by default for the Master Mode Control.

Mode on Run: Select the OpenWorkbench System Control Mode to enable when the OpenController settings in window containing this control are Run. Choices are None, Standby, Preview, and Run.

Mode on Stop: Select the OpenWorkbench System Control Mode to enable when the OpenController settings in window containing this control are set to Stop. Choice are None, Idle, and Standby.

Delay to run (secs): Enter a value in seconds to delay implementation of Mode on Run setting.

Delay to stop (secs): Enter a value in seconds to delay implementation of Mode on Stop setting.

Momentary Button Common Parameters

Server Name: Select the server name. The default value of **Local** selects the local server.

Primary Target: Select or type the name of the primary destination target. When an OpenWorkbench configuration is open, available targets can be selected using the Select Target dialog box. Click the look-up button to open the Select Target dialog box. Using the Select Target dialog boxes ensures valid formatting of target name.

The target should generally be the device name (from the OpenWorkbench file) followed by the parameter tag (from the RPvdsEx circuit). This should follow the form "dddd.parTag" for device name and parameter tag.

When linking controls together, and the target is the source, the target name will be a greater than symbol followed by the source control's My Name value followed by the setting name. This should follow the form "myname.settingname" e.g. ">FreqSlider.Value Shift" .

When the target is the destination, the target name will be a lesser than symbol followed by the source control's My Name value followed by the setting name. This should follow the form "myname.settingname" e.g. "<FreqSlider.Value Shift".

Target Channel: Enter the channel number.

Caption Text: Type text for a caption if desired. The Auto Caption check box must be cleared for the caption text to be used. The Caption Visible check box, in the Caption/Borders parameter group must also be selected.

Auto Caption: When the Auto Caption check box is selected, a caption will be automatically generated and applied to the control. The auto caption is based on the target value. Clear the Auto Caption check box to use a caption defined in the Caption Text box. The Caption Visible check box, in the Caption/Borders parameter group must also be selected.

Initialize Value: Type a value to be used as an initial value if the initialize mode is set to Init On Run or Init On Load.

Initialize Mode: Select a mode from the drop down list. The available choices are: None, Init On Run or Init On Load.

Button Text: Type text to be displayed on the button.

Value when On: Type value when on.

Value when Off: Type value when off.

Value in milliseconds for On time: Type the length of time for the control to stay on when clicked.

Scope/Pile Plot Common Parameters

Server Name: Select the server name. The default value of **Local** selects the local server.

Data Target: Select the data event (Store name) to be plotted.

Target Channel: Selects the channel for viewing. To view a single channel of data enter the desired channel number.

Caption Text: Type caption text to display on the plot. The Auto Caption check box must be cleared before caption text will be used.

Auto Caption: Select the check box to display an automatically generated caption for the plot. The auto caption is generated using the Store name. Clear the check box to hide the auto caption. The auto caption should be hidden if no caption is desired or if a user-defined caption should be used.

Poll Period: Enter a value in milliseconds to set the poll period. The poll period is a defined interval at which OpenController accesses control targets.

Channel Selector Visible: Select the check box to display a channel selector as part of the control. The channel selector is a slider that can be used to control which channel of data is used to animate a single view plot. By default the channel selector options include channels one through eight. The user can modify the number of channels or offset value in the Channel Selector parameter group.

Pile Depth: Set the number of traces that will be displayed. Set the Pile Depth to 1 to create a scope plot.

Multi View Enabled: Select the check box to view each channel, or sort code, of data in an individual plot.

Num Views: Select the number of channels or sort codes to view. By default, channels will be displayed beginning with channel 1.

Num Columns: Select the number of columns to display.

Category Coloring: Selects the trace coloring method. Traces can be seen in a single color (None), one color per channel (By Channel), or one color per sort code (By SortCode).

Scrolling Plot Common Parameters

Server Name: Select the server name. The default value of **Local** selects the local server.

Data Target: Select the data event (Store name) to be plotted.

Target Channel: Selects the channel for viewing. To view a single channel of data enter the desired channel number.

Caption Text: Type caption text to display on the plot. The Auto Caption check box must be cleared before caption text will be used.

Auto Caption: Select the check box to display an automatically generated caption for the plot. The auto caption is generated using the Store name. Clear the check box to hide the auto caption. The auto caption should be hidden if no caption is desired or if a user-defined caption should be used.

Poll Period: Enter a value in milliseconds to set the poll period. The poll period is a defined interval at which OpenController accesses control targets.

Channel Selector Visible: Select the check box to display a channel selector as part of the control. The channel selector is a slider that can be used to control which channel of data is used to animate a single view plot.

By default the channel selector options include channels one through eight. The user can modify the number of channels or offset value in the Channel Selector parameter group.

Scroll Sections: Selects the number of scroll sections to display.

Multi View Enabled: Select the check box to view each channel, or sort code, of data in an individual plot.

Num Views: Select the number of channels or sort codes to view. By default, channels will be displayed beginning with channel 1.

Num Columns: Select the number of columns to display. Leave this value set to 1 to see one channel per row.

Scrolling Threshold Common Parameters

Server Name: Select the server name. The default value of **Local** selects the local server.

Data Target: Select the data event (Store name) to be plotted.

Target Channel: Selects the channel for viewing. To view a single channel of data enter the desired channel number.

Caption Text: Type caption text to display on the plot. The Auto Caption check box must be cleared before caption text will be used.

Auto Caption: Select the check box to display an automatically generated caption for the plot. The auto caption is generated using the Store name. Clear the check box to hide the auto caption. The auto caption should be hidden if no caption is desired or if a user-defined caption should be used.

Poll Period: Enter a value in milliseconds to set the poll period. The poll period is a defined interval at which OpenController accesses control targets.

Threshold Target: The threshold target takes the threshold based on the scroll plot (which is usually a plot decimated signal). The output value is then sent to the threshold low parameter tag (ae~1).

Channel Selector Visible: Select the check box to display a channel selector as part of the control. The channel selector is a slider that can be used to control which channel of data is used to animate a single view plot. By default the channel selector options include channels one through

eight. The user can modify the number of channels or offset value in the Channel Selector parameter group.

Auto-Threshold S/N Factor: Select a choice from the drop down menu to determine the signal to noise factor that will be used to set the threshold when the auto-threshold feature is used. Auto sets the threshold based on any spike activity that is above the noise floor. Even if no spikes occur the control will calculate a threshold that will acquire some signals above the threshold. 2-1 through 5-1 selects a fixed ratio that generates a threshold that is x times greater than the noise floor.

Auto-Threshold Effort: Select low, medium, or high to determine how large a data block will be acquired before the threshold is calculated. High uses the largest block (taking the longest time) and small uses the smallest block (to calculate the threshold the quickest).

Auto-Threshold Polarity: Select Either, Positive Only, or Negative Only to determine if the threshold will look for positive going signals, negative signals, or signals in either direction. A fixed polarity can be used to separate different waveforms.

Scroll Sections: Selects the number of scroll sections to display.

Slider Common Parameters

Server Name: Select the server name. The default value of **Local** selects the local server.

Primary Target: Select or type the name of the primary destination target. When an OpenWorkbench configuration is open, available targets can be selected using the Select Target dialog box. Click the look-up button  to open the Select Target dialog box. Using the Select Target dialog boxes ensures valid formatting of target name.

The target should generally be the device name (from the OpenWorkbench file) followed by the parameter tag (from the RPvdsEx circuit). This should follow the form "dddd.parTag" for device name and parameter tag.

When linking controls together, and the target is the source, the target name will be a greater than symbol followed by the source control's My Name value followed by the setting name. This should follow the form "myname.settingname" e.g. ">FreqSlider.Value Shift"

When the target is the destination, the target name will be a lesser than symbol followed by the source control's My Name value followed by the setting name. This should follow the form "myname.settingname" e.g. "<FreqSlider.Value Shift"

Target Channel: Enter the channel number.

Caption Text: Type text for a caption if desired. The Auto Caption check box must be cleared for the caption text to be used. The Caption Visible check box, in the Caption/Borders parameter group must also be selected. The Caption Visible check box is selected by default for the slider.

Auto Caption: When the Auto Caption check box is selected, a caption will be automatically generated and applied to the control. The auto caption is based on the target value. Clear the Auto Caption check box to use a caption defined in the Caption Text box.

Initialize Value: Type a value to be used as an initial value if the initialize mode is set to Init On Run or Init On Load.

Initialize Mode: Select a mode from the drop down list. The available choices are: None, Init On Run or Init On Load.

Orientation: Select an orientation from a drop down list. Choices are: Vertical or Horizontal.

Pointer Style: Select a pointer style from a drop down list. Choices are: Led, Pointer, Bar, Light Bar.

Position Max: Enter the maximum value to be displayed for the slider.

Position Min: Enter the minimum value to be displayed for the slider.

Tick Precision: Enter the number of digits to be displayed after the decimal point for value labels along the slider.

SigGen Engine Common Parameters

Server Name: Select the server name. The default value of **Local** selects the local server.

SigGen Waveform Target: Select the parameter tag associated with the SigGen waveform buffer.

Buffer Length Target: Select the parameter tag associated with the length of the buffer.

Target Channel: Selects the channel for viewing. To view a single channel of data enter the desired channel number.

Caption Text: Type caption text to display on the plot. The Auto Caption check box must be cleared before caption text will be used.

Auto Caption: Select the check box to display an automatically generated caption for the plot. The auto caption is generated using the SigGen Waveform Target name.

Clear the check box to hide the auto caption. The auto caption should be hidden if no caption is desired or if a user-defined caption should be used.

SIG: This setting always reflects the current SGI value and can be used as the target of another control, allowing the SGI to be modified by another control, such as a slide switch.

Initialize SGI: Type a value to be used as an initial value if the initialize mode is set to Init On Run or Init On Load.

Initialize Mode: Select a mode from the drop down list. The available choices are: None, Init On Run or Init On Load.

SigGen File: Select the SigGen file to use with the SigGen control.

Slide Switch Common Parameters

Server Name: Select the server name. The default value of **Local** selects the local server.

Primary Target: Select or type the name of the primary destination target. When an OpenWorkbench configuration is open, available targets can be selected using the Select Target dialog box. Click the look-up button  to open the Select Target dialog box. Using the Select Target dialog boxes ensures valid formatting of target name.

The target should generally be the device name (from the OpenWorkbench file) followed by the parameter tag (from the RPvdsEx circuit). This should follow the form "dddd.parTag" for device name and parameter tag.

When linking controls together, and the target is the source, the target name will be a greater than symbol followed by the source control's My Name value followed by the setting name. This should follow the form "myname.settingname" e.g. ">FreqSlider.Value Shift"

When the target is the destination, the target name will be a lesser than symbol followed by the source control's My Name value followed by the setting name. This should follow the form "myname.settingname" e.g. "<FreqSlider.Value Shift"

Target Channel: Enter the channel number.

Caption Text: Type text for a caption if desired. The Auto Caption check box must be cleared for the caption text to be used. The Caption Visible check box, in the Caption/Borders parameter group must also be selected.

Auto Caption: When the Auto Caption check box is selected, a caption will be automatically generated and applied to the control. The auto caption is based on the target value. Clear the Auto

Caption check box to use a caption defined in the Caption Text box. The Caption Visible check box, in the Caption/Borders parameter group must also be selected.

Initialize Value: Type a value to be used as an initial value if the initialize mode is set to Init On Run or Init On Load.

Initialize Mode: Select a mode from the drop down list The available choices are: None, Init On Run or Init On Load.

Orientation: Select Vertical or Horizontal orientation.

Position Labels: Type position labels separated by a comma.

Position Values: Type values separated by a comma.

Snippet Sort Common Parameters

Server Name: Select the server name. The default value of **Local** selects the local server.

Data Target: Select the data event (Store name) to be plotted.

Target Channel: Select the channel for viewing. To view a single channel of data enter the desired channel number.

Caption Text: Type caption text to display on the plot. The Auto Caption check box must be cleared before caption text will be used.

Auto Caption: Select the check box to display an automatically generated caption for the plot. The auto caption is generated using the Store name. Clear the check box to hide the auto caption. The auto caption should be hidden if no caption is desired or if a user-defined caption should be used.

Poll Period: Enter a value in milliseconds to set the poll period. The poll period is a defined interval at which OpenController accesses control targets.

Channel Selector Visible: Select the check box to display a channel selector as part of the control. The channel selector is a slider that can be used to control which channel of data is used to animate a single view plot. By default the channel selector options include channels one through eight. The user can modify the number of channels or offset value in the Channel Selector parameter group.

Training Sample Size: Enter a value to determine the maximum number of samples used to sort spikes using more spikes (an increased sample size) allows individual units to be separated more effectively and rare units are more likely to be detected. However, if unit activity is low using a large sample size can take an inordinately long time.

Maximum Training Time: Enter a value in seconds to set an upper limit on the auto-sort process. If the training sample size is not reached in the maximum training time, the sort is based on the existing sample size.

Allow Unsorted Group: Select the check box to allow unsorted spikes.

Pile Depth: Set the number of traces that will be displayed.

Category Coloring: Selects the trace coloring method. Traces can be seen in a single color (None), one color per channel (By Channel), or one color per sort code (By SortCode).

Switch Button Common Parameters

Server Name: Select the server name. The default value of **Local** selects the local server.

Primary Target: Select or type the name of the primary destination target. When an OpenWorkbench configuration is open, available targets can be selected using the Select Target

dialog box. Click the look-up button  to open the Select Target dialog box. Using the Select Target dialog boxes ensures valid formatting of target name.

The target should generally be the device name (from the OpenWorkbench file) followed by the parameter tag (from the RPvdsEx circuit). This should follow the form "dddd.parTag" for device name and parameter tag.

When linking controls together, and the target is the source, the target name will be a greater than symbol followed by the source control's My Name value followed by the setting name. This should follow the form "myname.settingname" e.g. ">FreqSlider.Value Shift"

When the target is the destination, the target name will be a lesser than symbol followed by the source control's My Name value followed by the setting name. This should follow the form "myname.settingname" e.g. "<FreqSlider.Value Shift"

Target Channel: Enter the channel number.

Caption Text: Type text for a caption if desired. The Auto Caption check box must be cleared for the caption text to be used. The Caption Visible check box, in the Caption/Borders parameter group must also be selected.

Auto Caption: When the Auto Caption check box is selected, a caption will be automatically generated and applied to the control. The auto caption is based on the target value. Clear the Auto Caption check box to use a caption defined in the Caption Text box. The Caption Visible check box, in the Caption/Borders parameter group must also be selected.

Initialize Value: Type a value to be used as an initial value if the initialize mode is set to Init On Run or Init On Load.

Initialize Mode: Select a mode from the drop down list. The available choices are: None, Init On Run or Init On Load.

Button Text: Type text to be displayed on the button.

Value when On: Type value when on.

Value when Off: Type value when off.

Value Watch Common Parameters

Server Name: Select the server name. The default value of **Local** selects the local server.

Source Target: Select or type the name of the source target. When an OpenWorkbench configuration is open, available targets can be selected using the Select Target dialog box. Click the look-up button  to open the Select Target dialog box. Using the Select Target dialog boxes ensures valid formatting of target name.

The source target should be either the Store name (from the OpenWorkbench file) or the device name (from the OpenWorkbench file) followed by the parameter tag (from the RPvdsEx circuit). This should follow the form "ssss" for Store name or "dddd.partag" for device name and parameter tag.

When linking controls together, the target will be a greater than symbol followed by the source control's My Name value followed by the setting name. This should follow the form "myname.settingname" e.g. ">FreqSlider.Value Shift"

Target Channel: Enter the channel number.

Caption Text: Type text for a caption if desired. The Auto Caption check box must be cleared for the caption text to be used. The Caption Visible check box, in the Caption/Borders parameter group must also be selected. The Caption Visible check box is selected by default for the value watch.

Auto Caption: When the Auto Caption check box is selected, a caption will be automatically generated and applied to the control. The auto caption is based on the source target value. Clear the Auto Caption check box to use a caption defined in the Caption Text box.

Poll Period: Enter a value in milliseconds to set the poll period. The poll period is a defined interval at which OpenController accesses control targets.

Units Text: Enter the units text to be added to the display.

Precision: Enter the number of digits that to be displayed after the decimal point. The precision value should be less than the Number Digits value to display the desired precision.

Shared Common Parameters

Server Name: Select the server name. The default value of **Local** selects the local server.

Caption Text: Type caption text to display on the plot. The Auto Caption check box must be cleared before caption text will be used.

Auto Caption: Not used.

Hidden When Running: When the controls are run, the editor will be hidden from view.

Layout Parameter Group

7 Segment Layout Parameters

Number Digits: Enter the number of digits to be displayed. By default, the leading unused digits will be displayed as spaces. The total number of digits should be sufficient to display the desired precision.

Leading Style: Select a style for leading digits. Choices are: None, Zeros, and Spaces.

Show Sign:

Checked - show the +/- sign.

Unchecked - hide the +/- sign.

Precision: Enter the number of digits to be displayed after the decimal point. The precision value should be less than the Number Digits value to display the desired precision.

Knob Layout Parameters

Offset-X: X offset of knob from the frame (top left).

Offset-Y: Y offset of knob from the frame (top left).

Rotation Start: Enter a value in degrees for the starting point of the rotation.

Rotation Max: Enter a value in degrees for the ending point of the rotation.

Pos Display Visible:

Checked - show the current value on the knob.

Unchecked - do not show the current value on the knob.

Pos Display Unit: Type the unit of the value controlled by the knob. Units are displayed with the current value. The Pos Display Visible check box must be selected.

Pos Display Precision: Enter the number of digits to be displayed after the decimal point for the current value.

Linear Gauge Layout Parameters

Gauge Size: Enter a value for the gauge size. Auto Size must be cleared for the gauge size to be used.

Auto Size:

Checked - gauge size is automatically changed with the frame size.

Unchecked - gauge size is fixed even though the frame size is changed. Gauge size should be set in the Gauge Size box.

Offset-X: Enter a value for the X offset of gauge from the frame (right bottom).

Offset-Y: Enter a value for the Y offset of gauge from the frame (right bottom).

Inner Border Style: Select a style for the inner border. Choice include: None, Raised, and Lowered.

Background Color: Select a color for the gauge background from a color palette.

Arc Start: Enter the position in degrees for the starting position of the arc display.

Arc Range: Enter the range in degrees for the arc display. For example: 90 degrees for a quarter circle arc.

Logarithmic Gauge Layout Parameters

Offset-X: Enter a value for the X offset of gauge from the frame (right bottom).

Offset-Y: Enter a value for the Y offset of gauge from the frame (right bottom).

Inner Border Style: Select a style for the inner border. Choice include: None, Raised, and Lowered.

Background Color: Select a color for the gauge background from a color palette.

Arc Start: Enter the position in degrees for the starting position of the arc display.

Arc Range: Enter the range in degrees for the arc display. For example: 90 degrees for a quarter circle arc.

Slide Switch Layout Parameters

Orientation: Select Vertical or Horizontal orientation.

Label Position: Select Right/Bottom or Left/Top label position. If the slide switch orientation is vertical, Right/Bottom places the value labels at the below the slide track and Left/Top places the value labels below the slide track. If the orientation is horizontal, Right/Bottom places the value labels at the right of the slide track and Left/Top places the labels at the left of the slide track.

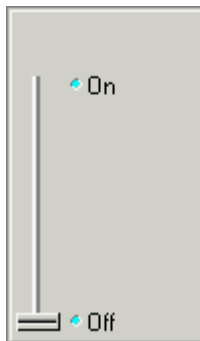

Orientation = Vertical

Label Position = Right/Bottom

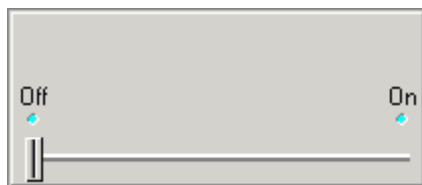

Orientation = Horizontal

Label Position = Left/Top

Polling Parameter Group

Modifier Control Polling Parameters

Poll Period: Enter a value in milliseconds to set the poll period. The poll period is a defined interval at which OpenController accesses control targets.

Read Back Active: Select the check box to set the control to read back the current value. If the control access a value that might be changed (such as another control), selecting this check boxes ensures that the appearance of the control reflects the current value.

Visualization Control Polling Parameters

Poll Period: Enter a value in milliseconds to set the poll period. The poll period is a defined interval at which OpenController accesses control targets. OpenController does not directly access parameter tags or data Stores. Instead OpenController polls the Workbench for all parameter tags and Stores. The more it polls the Workbench the greater the load it places on both applications, Workbench to serve up the data and Controller to take the data and display it.

Plot Updating: Select an updating method from a drop down list. Choices include high load, medium load, and low load. This setting determines how plots are updated as it relates to the demand on the system.

High load places the greatest demand on the system. All data acquired since the last update is used to update the plot allowing you the best possible visualization but limiting the processing power available to the system for other tasks.

Low load places the least demand on the system by grabbing only a subset of the data (for example, 3 of 10 acquired snippets) to update the plot. This leaves more processing power for other tasks.

Regardless of the setting selected here, all data is retained in the tank and can be used for later analysis. Typically, users should select the lowest load setting that provides an adequate representation of the data for the user's purposes, such as making real-time decisions and modifications or monitoring the experiment.

Scale Parameter Group

Knob Scale Parameters

Scale Minimum: Enter the minimum value for the control.

Scale Maximum: Enter the maximum value for the control.

Show Labels: Show value labels for major tick mark positions. Labels can be shown even if tick marks are not shown. The number of labels shown is determined by the Major Ticks Count setting.

Label Precision: Enter the number of digits to be displayed after the decimal point for value labels found on the control.

Label Margin: Enter the number of pixels of space desired between labels and the tick arc.

Show Major Ticks: Select the check box to show major ticks.

Major Ticks Count: Enter the number of major tick marks to display on the control. The Show Major Ticks check box must be selected before major tick marks become visible.

Show Minor Ticks: Select the check box to show minor ticks.

Minor Ticks Count: Enter the number of minor tick marks to display between two major tick marks on the control. The Show Minor Ticks check box must be selected before minor tick marks become visible. Minor tick marks can be used even if the major tick marks are not shown.

Key Arrow Step Size: Enter a step size for knob movements when using the arrow keys on the keyboard to control the knob. The step size number corresponds to control values according to the minimum and maximum scale settings.

Tip: If the arrow keys do not change the knob position, try moving the knob with the mouse once. After the knob position has been changed once the key arrows can be used for subsequent movements.

Key Page Step Size: Enter a step size for knob movements when using the Page Up and Page Down keys on the keyboard to control the knob. The step size number corresponds to control values according to the minimum and maximum scale settings.

Tip: If the Page Up and Page Down keys do not change the knob position, try moving the knob with the mouse once. After the knob position has been changed once the Page Up and Page Down keys can be used for subsequent movements.

Gauge Scale Parameters

Scale Minimum: Enter the minimum value for the control.

Scale Maximum: Enter the maximum value for the control.

Show Labels: Show value labels for major tick mark positions. Labels can be shown even if tick marks are not shown. The number of labels shown is determined by the Major Ticks Count setting.

Label Precision: Enter the number of digits to be displayed after the decimal point for value labels found on the control.

Label Margin: Enter the number of pixels of space desired between labels and the tick arc.

Show Major Ticks: Select the check box to show major ticks.

Major Ticks Count: Enter the number of major tick marks to display on the control. The Show Major Ticks check box must be selected before major tick marks become visible.

Show Minor Ticks: Select the check box to show minor ticks.

Minor Ticks Count: Enter the number of minor tick marks to display between two major tick marks on the control. The Show Minor Ticks check box must be selected before minor tick marks become visible. Minor tick marks can be used even if the major tick marks are not shown.

Slider Scale Parameters

Position Max: Enter the maximum value for the control.

Position Min: Enter the minimum value for the control.

Show Major Ticks: Select the check box to show major ticks.

Show Minor Ticks: Select the check box to show minor ticks. Minor ticks can only be shown when the major ticks are also shown.

Show Tick Labels: Show value labels for major tick mark positions. Labels can be shown even if tick marks are not shown. The number of labels shown is determined by the Major Ticks Count setting.

Tick Precision: Enter the number of digits to be displayed after the decimal point for value labels found on the control.

Major Tick Count: Enter the number of major tick marks to display on the control. The Show Major Ticks check box must be selected before major tick marks become visible.

Minor Tick Count: Enter the number of minor tick marks to display between two major tick marks on the control. The Show Major Ticks and Show Minor Ticks check boxes must be selected before minor tick marks become visible.

Tick Label Margin: Enter the number of pixels of space desired between labels and the tick arc.

Minor Tick Alignment: Select an alignment style for minor tick marks. Choices are: Inside, Center, and Outside. Inside positions tick marks closer to the slider bar and Outside positions tick marks closer the labels.

Target Parameter Group

Biquad Coefficient Generator Control Target Parameters

My Name: A unique name for the control. A name will be automatically generated or the user can enter a name of their choice. When controls are linked, this value can be used as a part of the target path.

Repaint Target on Update: Not used.

Server Name: Select the server name. The default value of **Local** selects the local server.

Coef Target: Select the parameter tag associated with the >Coef line in the Biquad component.

Delay Line Target: Select the parameter tag associated with the >Delay line.

Target Channel: Enter the channel number.

Data Table Control Target Parameters

My Name: A unique name for the control. A name will be automatically generated or the user can enter a name of their choice. When controls are linked, this value can be used as a part of the target path.

Repaint Target on Update: When the primary or alternate target is a control setting, the target control will be repainted (refreshed) when the value is changed.

Server Name: Select the server name. The default value of **Local** selects the local server.

Master Mode Control Target Parameters

My Name: A unique name for the control. A name will be automatically generated or the user can enter a name of their choice. When controls are linked, this value can be used as a part of the target path.

Server Name: Select the server name. The default value of **Local** selects the local server.

Modifier Control Target Parameters

My Name: A unique name for the control. A name will be automatically generated or the user can enter a name of their choice. When controls are linked, this value can be used as a part of the target path.

Repaint Target on Update: When the primary or alternate target is a control setting, the target control will be repainted (refreshed) when the value is changed.

Server Name: Select the server name. The default value of **Local** selects the local server.

Primary Target: Select or type the name of the primary destination target. When an OpenWorkbench configuration is open, available targets can be selected using the Select Target dialog box. Click the look-up button  to open the Select Target dialog box. Using the Select Target dialog boxes ensures valid formatting of target name.

The target should generally be the device name (from the OpenWorkbench file) followed by the parameter tag (from the RPvdsEx circuit). This should follow the form "dddd.parTag" for device name and parameter tag.

When linking controls together, and the target is the source, the target name will be a greater than symbol followed by the source control's My Name value followed by the setting name. This should follow the form "myname.settingname" e.g. ">FreqSlider.Value Shift"

When the target is the destination, the target name will be a lesser than symbol followed by the source control's My Name value followed by the setting name. This should follow the form "myname.settingname" e.g. "<FreqSlider.Value Shift"

Alt. Target-1: Select an alternate destination target. See Primary Target above.

Alt. Target-2: Enter an alternate destination target. See Primary Target above.

Alt. Target-3: Enter an alternate destination target. See Primary Target above.

Target Channel: Enter the channel number.

Plots and Graphs Target Parameters

My Name: A unique name for the control. A name will be automatically generated or the user can enter a name of their choice. When controls are linked, this value can be used as a part of the target path.

Server Name: Select the server name. The default value of **Local** selects the local server.

Data Target: Enter the Store name.

Target Channel: Enter the channel number.

SigGen Engine Control Target Parameters

My Name: A unique name for the control. A name will be automatically generated or the user can enter a name of their choice. When controls are linked, this value can be used as a part of the target path.

Repaint Target on Update: Not used.

Server Name: Select the server name. The default value of **Local** selects the local server.

SigGen Waveform Target: Select the parameter tag associated with the SigGen waveform buffer.

Buffer Length Target: Select the parameter tag associated with the length of the buffer.

Target Channel: Enter the channel number.

Shared Target Parameters

My Name: A unique name for the control. A name will be automatically generated or the user can enter a name of their choice. When controls are linked, this value can be used as a part of the target path.

Server Name: Select the server name. The default value of **Local** selects the local server.

Visualization Control Target Parameters

My Name: A unique name for the control. A name will be automatically generated or the user can enter a name of their choice. When controls are linked, this value can be used as a part of the target path.

Server Name: Select the server name. The default value of **Local** selects the local server.

Source Target: Select or type the name of the source target. When an OpenWorkbench configuration is open, available targets can be selected using the Select Target dialog box. Click the look-up button  to open the Select Target dialog box. Using the Select Target dialog boxes ensures valid formatting of target name.

The source target should be either the Store name (from the OpenWorkbench file) or the device name (from the OpenWorkbench file) followed by the parameter tag (from the RPsVsEx circuit). This should follow the form "ssss" for Store name or "dddd.partag" for device name and parameter tag.

When linking controls together, the target will be a greater than symbol followed by the source control's My Name value followed by the setting name. This should follow the form "myname.settingname" e.g. ">FreqSlider.Value Shift"

Target Channel: Enter the channel number.

Value Control Parameter Group

Visualization/Modifier Control Value Control Parameters

Value: Type the target(s) value if the initialize mode is None.

Initialize Value: Type the value to be used for initializing when the initialize mode is Init On Run or Init On Load.

Initialize Mode: Select an initialize mode to determine how the value will be initialized.

None - sets input value to the Value.

Init On Run - sets the input value to the Initialize Value when running.

Init On Load - sets the input value to the Initialize Value when loading.

Value Scale: Enter a value such that the input value = value * value scale + value shift.

Value Shift: Enter a value such that the input value = value * value scale + value shift.

SigGen Engine Control Value Control Parameters

SIGI: This setting always reflects the current SIGI value and can be used as the target of another control, allowing the SIGI to be modified by another control, such as a slide switch.

Initialize SGI: Type a value to be used as an initial value if the initialize mode is set to Init On Run or Init On Load.

Initialize Mode: Select a mode from the drop down list. The available choices are: None, Init On Run or Init On Load.

OpenScope Reference

In the OpenScope Reference you will find:

A reference guide to the OpenScope Workspace and the basics of adding and modifying plots.

Plot Types

Step-by-step guides to creating each of the seven available plot types.

Plot Settings Reference

An in-depth reference covering many of the plot settings available from the Property Settings dialog box.

About OpenScope

OpenScope is a user-customizable display and analysis application. It is designed for visualization of data stored in the OpenEx data tank format. A wide variety of plot types and flexible settings provide the user with the ability to view the desired data in the most useful way.

The source of this flexibility is the data tank format, which allows for the rapid sorting of many megabytes of stored data. Powerful tank sorting algorithms sort and serve data to the OpenScope plots, which are updated as each of the selected data tank elements become available. This means that stored data can be displayed dynamically during the course of an experiment, or that the entire experiment can be re-played later as if the data were just being acquired.

Unlike traditional, turn-key applications, OpenScope and the data tank sorting algorithms allow for the relationships between selected data elements to be calculated and displayed dynamically. For example, data corresponding to user specifications, such as a subset of stimulus parameters, can be sorted into individual plots as they are stored to the tank. Moreover, a single data set can be simultaneously displayed in a number of perievent histograms, each synchronized to different, user-selected, events.

OpenScope provides eight customizable plot types including: pile, scroll, raster, XY, feature, chart, histogram, and activity. A single OpenScope file can include a variety of multi-view and single channel plot types to display different types of data. For even greater flexibility, several OpenScope windows, each viewing data from a different data tank, can be opened simultaneously.

As part of the OpenEx suite, OpenScope can be used on any computer with local or network access to the data tank. This provides users the ability to share information across a network.

Getting started with OpenScope begins with selecting data. Once the data tank has been identified plots can quickly be added and customized to meet a variety of research needs. Plot configurations can be saved in a file that includes information about the tank and block where the data is stored. A file can also be used to view other similar data sets. Simply open the file and select a new tank and block containing the same data events. TDT provides several example files that can be used for common data types or modified for use with similar data.

About Adding Plots

An auto-generated multi-plot similar to the one found in OpenWorkbench can be added by dragging a Block from the Block list to the grid. The multi-plot will contain a plot for each data event (or Store) found in the block. Users can make limited modifications to suit their needs.

Individual plots can be added to the grid area by dragging a data event to the grid or by using the Add Plot command on the Edit menu. Either option provides several plot types to choose from. When a plot is added using the Add Plot command the data source must be defined. Other settings, such as Source Channel, Scaling, and Appearance use default values until the settings are modified. **See the Plot Types section, page 239 for step-by-step instructions for adding specific plot types.**

After one or more plots have been created they can be copied and pasted or pasted as a new type. This method works well when several similar plots are needed. Copied plots can be modified quickly to produce a complete set of plots. Multiple plots can also be copied and pasted from other existing files.

Before plots can be added a tank must be available and selected in the Tank Select window. If no tanks are available in the tank select window, a tank must be added to the OpenEx registry.

About Plot Settings

Plots can be modified using the Setup Properties dialog box. When plots are grouped, setting changes can be made to all plots in the group.

Plot settings are grouped into parameter groups. The available settings are similar for each plot type. Settings unique to a plot type can generally be found under the Common and Behavior parameter groups.

Plot Setting Parameter Groups:

Common	The most commonly changed settings for the selected plot type are displayed in the Common parameter group. Related settings are also grouped by color within the common parameter group. The settings found in this group can also be found in the other parameter groups. There is a Common parameter group for each plot type: pile, scroll, histogram, raster, XY, feature, chart, and activity.
Data Source	The Data Source group includes settings to identify the data source as well as settings to control source channel, sorting code, and the data source definition. Additional settings to identify a second data source are available in the XY Plot Data Source group.
Multi View	The Multi View group includes settings to enable and control display of multi-channel viewing. When multi view is not enabled plots show results from a single channel, or sort, or all channels, or sorts, displayed together.
Behavior	The Behavior group contains settings unique to the plot type.
Pile	The Behavior group for the pile plot includes a setting for the pile depth.
Scroll	The Behavior group for the scroll plot includes a setting to determine how many sections will be displayed before scrolling.
Histogram	The Behavior group for histograms includes settings to control the event used for time, time values for refreshing, time span, and bin width.
Raster	The Behavior group for raster plots includes settings to control the event used for time, time values for refreshing, and time span.
XY Plot	The Behavior group for XY plots includes a setting for time span to be displayed on the x-axis.

Feature	The Behavior group for the feature plot includes a setting for the minimum number of cloud points to be displayed.
Chart	The Behavior group for chart plots includes a setting for time span to be displayed on the x-axis.
Activity	The Behavior Group for activity plots includes settings for minimum and maximum values and corresponding color selections.
Refresh Control	The Refresh Control group includes settings to control how and when the plot is refreshed.
Scaling	The Scaling group includes settings to control plot scaling including the Auto Scale feature. Auto Scale can be disabled (None), set to scale at all times to ensure all values can be shown on the plot (Active), or set to scale only during the first 3 seconds (Smart).
X-Axis Setup	The X-Axis Setup group includes settings to control labels, unit name, unit factor, and offset for the x-axis. The X-Axis Units Factor defines the scalar of the default number of points.
Y-Axis Setup	The Y-Axis Setup group includes settings to control labels, unit name, unit factor, and offset for the y-axis. The Y-Axis Units Factor defines the scalar of the default number of points.
Appearance	<p>The Appearance group includes settings to control the plot appearance, such as title, title position, font size, and multi-channel grid.</p> <p>When you title a plot, the Plot Auto Title check box must be cleared before the change can be applied.</p>
Margins	The Margins group includes settings to control the plot margins.
Colors	The Colors group includes settings to control the color of chart elements. Category Coloring can be set to use the trace color to draw the plot (None), to automatically select the color for each channel (By Channel), or to automatically select the color for each sort code (By SortCode).
Filtering	The Filtering group includes settings to enable or disable an FIR filter algorithm and to set parameters for the filter.

For more information about plot settings, see the plot settings reference, page 260.

Using Epochs with OpenScope

OpenScope uses epochs to organize and display data. Epochs are stored events that are associated with a block's timeline.

Epochs serve two main functions:

- To display data in groups so that each group is associated with a particular event.
- To change or refresh the plot in response to changes in an event.

Plot settings related to epoch events can be found in the Refresh Control and Behavior parameter groups in a plot's property settings dialog box.

Refresh Control: All plots have refresh control settings that allow the user to define a refresh epoch. When a refresh epoch event is defined the plot will be refreshed based on the epoch value according to the settings in the Refresh Control parameter group. To learn more about the settings see Refresh Control parameter group settings, page 261.

Behavior: Histogram and raster plots use a time reference epoch event to sort and display data and to determine what data is plotted according to settings in the Behavior parameter group. To learn more about the settings see Histogram Behavior parameter group settings or Raster Behavior parameter group settings, page 263.

The Refresh Control and Behavior settings can be used independently or in combination. Because different epoch events can be selected for the Refresh Control and Behavior, the data can be refreshed by a value that is independent of the time reference epoch. This behavior allows users to develop several graphs each associated with a unique event. Data can then be compared across event parameters.

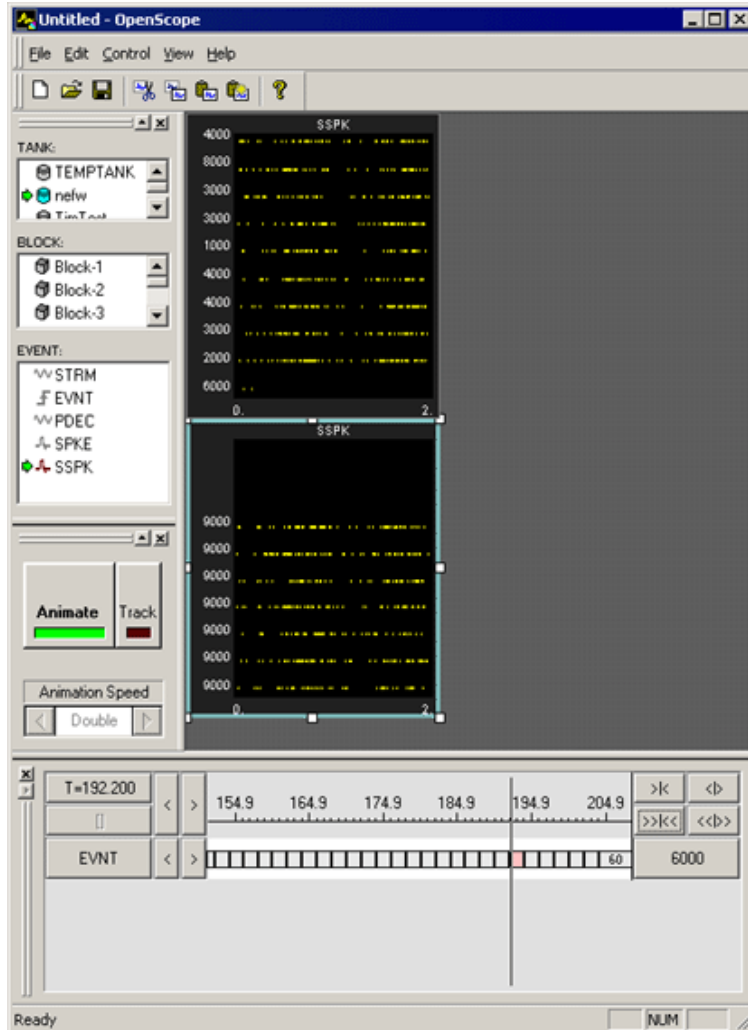

Raster Plots with different Behavior settings

The OpenScope plots show two raster plots that differ in their behavior. The top plot displays all the data and the bottom plot displays only data in events that have the value 2000. The difference between the two plots is how the behavior settings use epoch events. In the bottom plot the behavior of the plot is controlled by setting limits on the range of epoch events that are displayed.

Using Refresh Control Settings

Refresh Control settings determine when displayed data is removed from the display. Epoch events can be used to control what set of data is shown on screen. For example, a pile plot can be set to remove old data and show only new data each time the epoch event changes. This would allow users to examine spike patterns that are associated with an event, such as a single stimulus event.

To view data for a single event value at a time:

1. Select the desired epoch event in the **Refresh Epoch Name** box in the plot's refresh Control parameter group settings.
2. Enter the high and low epoch values for the range over which the plot should refresh in the **Strobe Epoch Low Range** and **Strobe Epoch High Range** boxes.

3. Select the **Refresh on Change** check box. If Refresh on Change is not selected old data is removed and new data is displayed on each epoch within the boundary conditions set by Strobe Epoch Low Range and Strobe Epoch High Range.

In many cases the user might want to refresh on a particular event. For example, if an experiment calls for ten presentations of the same stimulus; after the last stimulus, the stimulus can be updated. If the stimulus number is included as an epoch then the plot can be refreshed when the stimulus number reaches a certain value.

Using Behavior Settings in Raster and Histogram Plots

Behavior settings determine how data is displayed, and what data is displayed, in a plot. When an epoch event is defined for a Raster or Histogram plot only the data associated with the epoch's scalar values will be displayed. For example, if a user wants to display only signal responses that occur when a particular stimulus is presented, such as a 9 kHz tone, the plot behavior can be set so that a new raster pattern is displayed only when this event occurs.

Workspace Basics

About the OpenScope Workspace

The OpenScope workspace includes four collapsible sub-windows and a main grid area where plots can be displayed. A menu bar and a toolbar are provided for easy access to commands.

Grid Area

Tank Select Window

Control Window

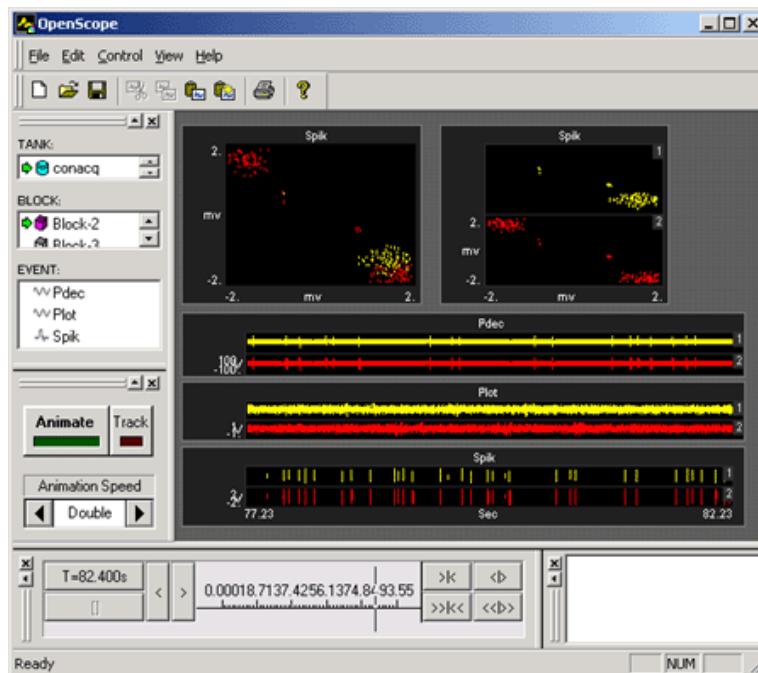

Time Control Window

Messages Window

Using the Tank Select Window

The Tank Select window allows you to identify the data to be plotted. Before you can plot data the tank containing the data must be selected. Users can create plots by dragging a data event to the grid area.

The window is divided into three areas: TANK, BLOCK, and EVENT. Clicking an object in any area selects the object. Right-clicking an area displays a shortcut menu that includes common commands.

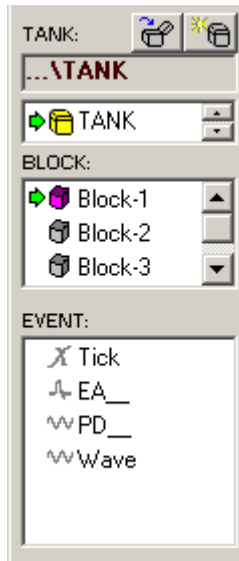

The TANK area lists tanks that have been added to the OpenEx registry. The Details view displays the name and path for each tank. Click a tank to select it.

The BLOCK area displays the blocks available in the tank selected in the Tank area. The Details view displays a name, date, and starting time, duration, stop time, owner, and memo area for each block of data in the selected tank. Click a block to select it.

The EVENT area displays information about events (OpenWorkbench Stores) for the block selected in the BLOCK area. Click an event to select it. Drag an event to the grid to create a plot using that data.

The Select Tank window is accessed from the Data Source command on the File menu and can be used as an alternative means of selecting data for animation when the Tank Select window (Tank Navigator) is not displayed.

Controlling Data Visualization

The Control Window provides controls for animating stored data or tracking data as it is acquired. Both methods utilize data stored in the tank; however, tracking ensures that the most recently stored data is being viewed.

A control is also provided for selecting the speed at which tank data is displayed during animation. Animation of the block of data selected in the Tank Select window begins at the time stamp indicated in the Time Control window. The animation then returns to the beginning of the block and plays in a loop until a new block is selected. When tracking data animation speed settings and block selection are not needed and are unavailable.

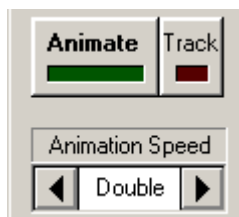

The Animate button toggles plot animation on and off.

The Track button toggles tracking on and off.

The Animation Speed control scrolls right or left through a list of animation speed choices.

Animation Speed choices include:

8th	Half	Double	Octal
Quarter	Normal	Quad	

Using Setup Properties Dialog Boxes

The appearance and behavior of each plot can be modified using the Setup Properties dialog box. The Setup Properties dialog box contains all of the customizable settings for a selected plot.

To open the Setup Properties dialog box for a plot, double-click the plot in the grid area of OpenScope.

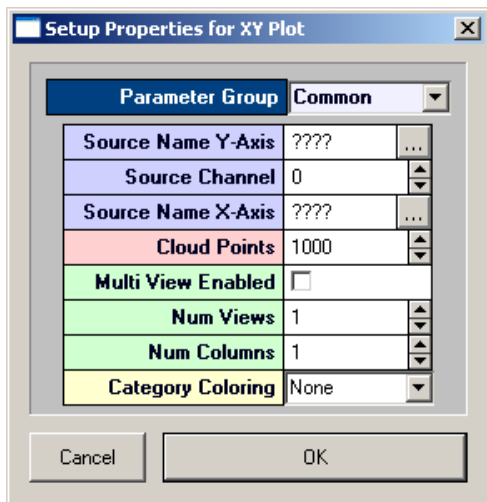

While all Setup Properties dialog boxes look and behave in a similar fashion, the settings available depend upon the plot being modified.

Plot settings are grouped into parameter groups. The Setup Properties dialog box opens with the most commonly used settings for the selected plot displayed.



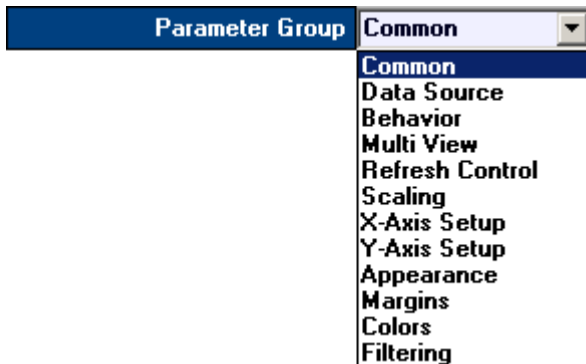

To display the settings available in another group, click the Parameter Group value box and select the group from the list.



Source Settings

When settings, such as Source Name, must be set using the name of an event a Lookup button  is located to the right of the value box. Clicking the Lookup button opens an Event Selection window.

EVENT: @Local.C:\TDT\OpenE\Tank\TANK.Block-6...

EvID	EvType	DForm	nSize	Fs
 Tick	Strobe+	Double	0	0
 Snip	Snip	Float	32	24414.1
 PDec	Stream	Short	32	381.5
 Rate	Stream	Float	16	190.7

In the Event Selection window, a list of available events in the current block is displayed. Events are organized in rows. The EvID (event ID) corresponds to the OpenWorkbench Store name or Tank Code (for secondary tags). The event ID is preceded by an icon to indicate the type of event, such as snippet, continuous waveform. Epoch events are marked with the Epoch icon .

Using the Time Control Window

The Time Control window provides a timeline and vertical line indicator that moves as data is animated. The Time Control Window can also be used to move to a particular time or event.

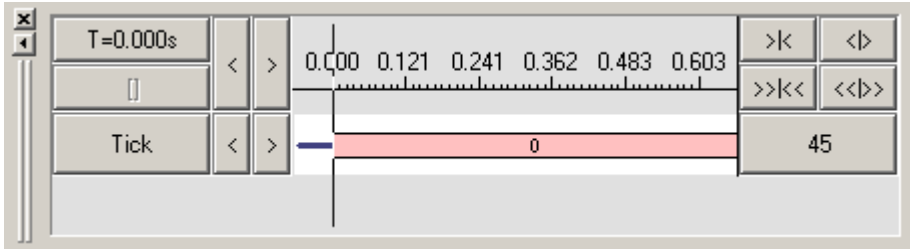

Epochs, or indexed events, are also added to the window. The Time Control window gives a precise description of when data was collected.

Timeline by Time Stamps

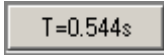
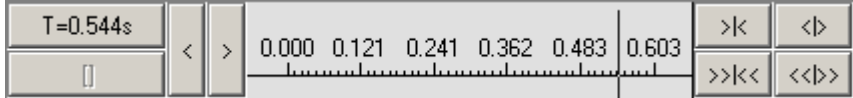

The current time stamp.







Moves the indicator back by time stamps.







Moves the indicator forward by time stamps.

Scale Controls

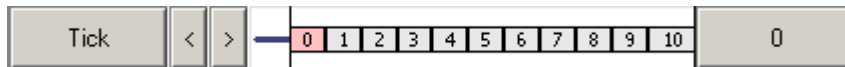
	Expands scale in small steps.
	Shrinks scale in small steps.
	Expands scale in large steps.
	Shrinks scale in large steps.

Timeline by Events



	The name of event displayed on corresponding line.
	Moves the indicator back by events.
	Moves the indicator forward by events.
	The current event value.

Using the Select Tank Window

The Select Tank window is accessed from the Data Source command on the File menu and can be used as an alternative means of selecting data for animation when the Tank Select window (Tank Navigator) is not displayed.

Detailed information about the data is displayed in the three interdependent areas of the window and commands for each area are available from a shortcut menu (right-click). The TANK area lists tanks that have been added to the OpenEx registry. Selecting a Tank displays its blocks and events (OpenWorkbench Stores) in the corresponding areas. The BLOCK area also provides access to the block information entered at the time the block was acquired. Block notes for a selected block can be accessed using the Information command on the BLOCK area shortcut menu.

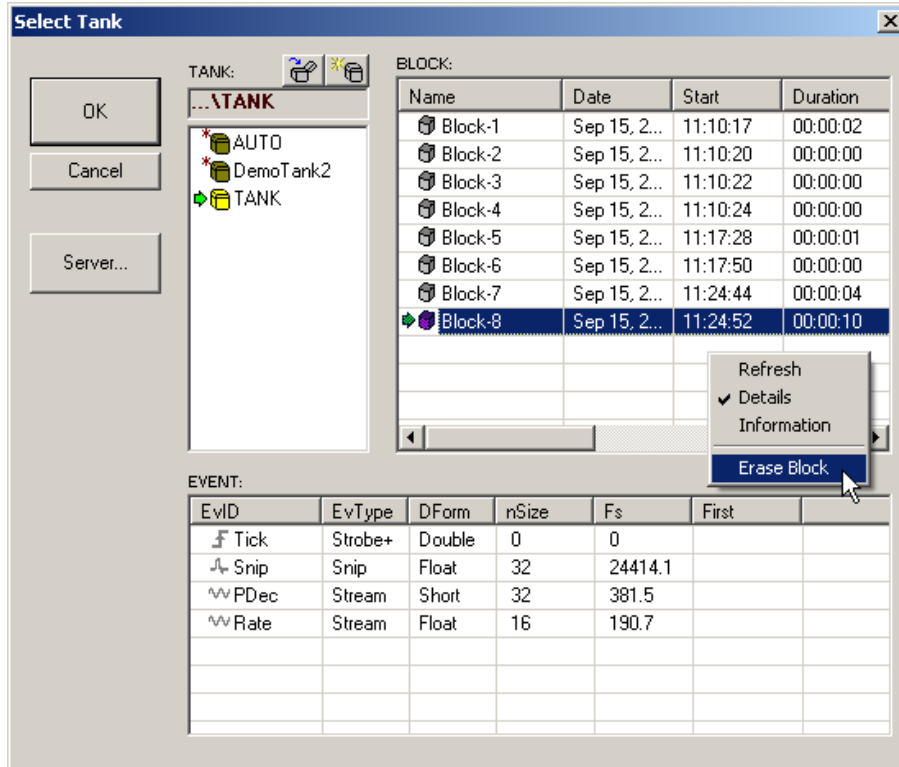
**OK Button**

The OK button updates OpenScope to use the selected Tank and Block for data animation.

Cancel Button

The Cancel button closes the Select Tank window without updating the selected Tank and Block in OpenScope.

Note: Changes such as erasing tank data or erasing blocks are NOT canceled.

Server Button

The Server button displays the Select Server window allowing users to view, add, remove, or test servers. The shortcut menu is displayed by right-clicking the SERVER area.

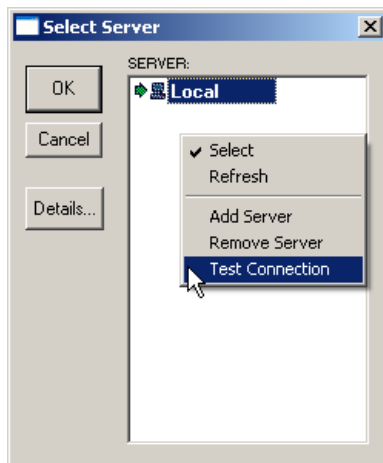

Shortcut Menus

The following context sensitive menus are available by right-clicking the corresponding area of the Select Tank window.

TANK Shortcut Menu

Browse for Tank	Browse for folder
Create New Tank	Opens the Select Tank file dialog box so that a tank can be added.
Register Tank	Adds the selected tank to the Windows Registry.
UnRegister tank	Removes the selected tank from the Windows Registry. The tank can still be used on the local machine.
Test Tank	Tests the connection to the server and opens and closes the tank file.
Reset Tank	Resets the selected tank file. This option returns the tank file to a state in which data can be read from or written to the tank.
Show Full Path	Toggles detail view on and off. In details view the path to the tank is displayed.
Refresh Tank List	Refreshes the Tank box display.
Show Legacy Tanks	Displays registered legacy format tanks in the tank list.
Find Legacy Tanks	Opens the Select Tank File dialog box and allows users to browse for tanks stored in the legacy format by showing files with a .tbk file extension.

BLOCK Shortcut Menu

There is no shortcut menu for the BLOCK area.









EVENT Shortcut Menu

Refresh	Updates the EVENT area to reflect recent changes to Tank, block, or event information.
Details	Toggles Details view on or off. Details view includes: event ID (Store name), event type (such as stream, snip, or strobe), data format (such as float, integer, or double), nSize (number of samples per acquired event), Fs (sampling frequency), and the time stamp value of the first event.

The Toolbar and Menus

The OpenScope Toolbar

The toolbar provides buttons for the most common commands.

	New	Opens a new OpenScope file.
	Open	Opens an existing OpenScope file.
	Save	Saves the current OpenScope file.
	Cut	Cuts the selected plot or plots.
	Copy	Copies the selected plot or plots.
	Paste	Pastes the most recently cut or copied plot or plots.
	Paste New Type	Pastes a new plot type from the most recently cut or copied plot.
	About	Displays version and copyright information for OpenScope.

OpenScope File Menu

Some Items on the OpenScope File menu are not available when running in OpenProject.

Note: To save changes to a file that is part of an OpenEx project, save the project.

New	Opens a new OpenScope file.
Open	Opens the Open dialog box so that an existing OpenScope file can be opened.
Save	Saves the current OpenScope file with the current name. If the file has not previously been saved the Save As dialog box opens.
Save As	Opens the Save As dialog box so that the OpenScope file can be saved with a new name.
Data Source	Opens the Tank Select dialog box. This Tank Select dialog box is similar to the Tank Select window and allows the user to select data, add or remove tanks, view block information, and erase blocks.
Recently Used Files	The third section of the File menu lists recently used files. Clicking a file name opens the file.
Exit	Closes the OpenScope application.

OpenScope Edit Menu

Cut	Cuts the selected plot or plots.
Copy	Copies the selected plot or plots.
Paste	Pastes the most recently cut or copied plot or plots.
Paste Special	Pastes a new plot type using the data source from the most recently cut or copied plot.
Add Plot	Opens a sub menu of plot types. Clicking a plot type adds a blank plot of that type to the grid area.
Remove Selected Plot	Removes the selected plot.
Modify Plot(s)	Opens the Plot Setup dialog box for the selected plot.
Group	Groups selected plots so that they can be labeled and moved together.
Ungroup	Ungroups plots in a selected group.
Preferences	Opens the Setup Preferences dialog box. This dialog box can be used to customize the appearance of the grid area.

OpenScope Control Menu

Animate	Animates plots with data in the block selected in the Tank Select window.
Track Active	Animates plots with tracked data.
Halt	Stops animation or tracking.

OpenScope View Menu

Toolbar	Toggles the toolbar between displayed and hidden.
Status Bar	Toggles the status bar between displayed and hidden.
Tank Navigator	Toggles the Tank Select window between displayed and hidden.
Time Navigator	Toggles the Time Control window between displayed and hidden.
Control Window	Toggles the Control window between displayed and hidden.

Message Window	Toggles the Message Window between displayed and hidden.
Verbose Messaging	Toggles verbose messaging on and off.
Customize Toolbars	Opens the Customize dialog box. The Customize dialog box allows you to customize the appearance of the menu bar and toolbar.

OpenScope Help Menu

About OpenScope	Displays version and copyright information for OpenScope.
------------------------	---

Plot Types

Selecting Data

Before you can plot data, the tank and block within the tank must be selected in the Tank Select window of OpenScope.

To select data from a tank:

1. Click the tank name in the **TANK** area of the **Tank Select** window.
2. Click the block name in the **BLOCK** area of the **Tank Select** window. The events contained in the selected block will be displayed in the **EVENT** area. Each event corresponds to an OpenWorkbench Store.

Note: If a tank does not appear in the Tank Select window it must first be added to the OpenEx registry.

After data is selected, plots can be created using the selected data.

Creating Pile Plots

Pile plots are designed to visualize small data buffers (<500) for quick recognition of differences in waveform properties. Pile plots are commonly used when extracellular recordings from neurons are examined to separate out single-unit activity. Users can use pile plots to view time stamped buffers, called snippets, or synchronized buffers. In a pile plot, the Y-axis is signal intensity such as voltage or dB and the X-axis is the record size in samples. Waveforms are layered over one another and centered along the X-axis. As the buffers pile up differences in the shape of the waveforms can easily be distinguished.

To quickly create a pile plot for a single channel of the selected data:

1. Drag a data event from the Tank select window to the grid area.
The Select Plot Type box opens.

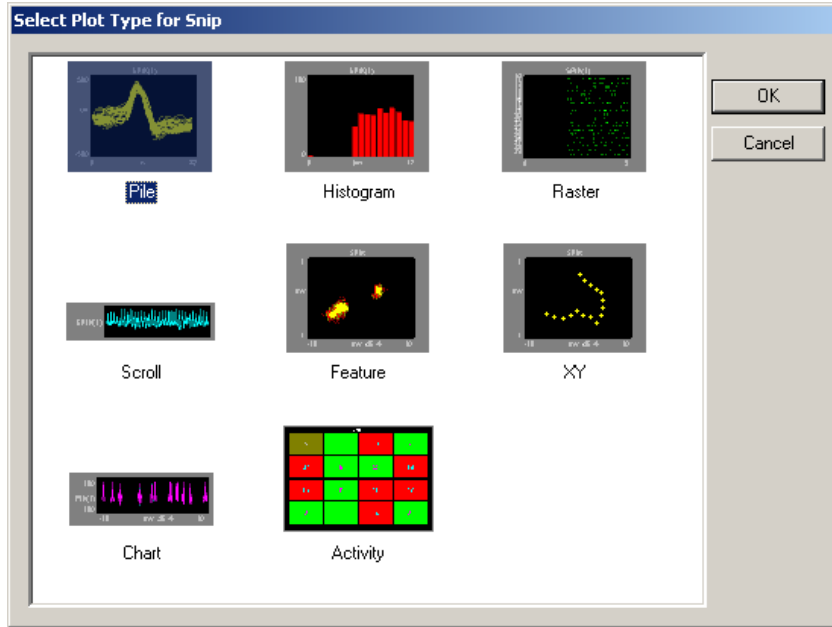

2. Click **Pile**.

The pile plot is added to the grid area and the Setup Properties dialog box opens with the most commonly used settings for the pile plot displayed.

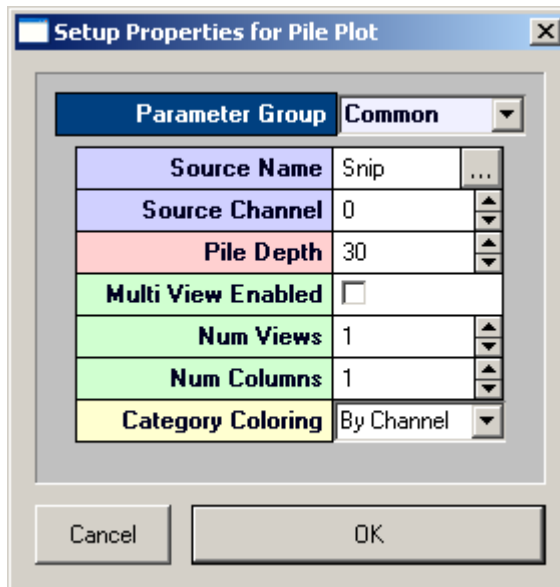

Settings groups include:

- Common - pg. 265
- Data Source - pg. 267
- Behavior - pg. 263
- Multi View - pg. 260
- Refresh Control - pg. 261
- Scaling - pg. 261
- X-Axis Setup - pg. 262
- Y-Axis Setup - pg. 262
- Appearance - pg. 195
- Margins - pg. 191
- Colors - pg. 260
- Filtering - pg. 260

Related settings are grouped together by color. Other settings are available by clicking the **Parameter Group** box and selecting a settings group.

3. Enter the desired channel number in the **Source Channel** box.
4. Channel information is available in the corresponding OpenWorkbench file.
5. In the **Pile Depth** box, enter the minimum number of wave forms to be displayed. The plot will be refreshed when the number of traces reaches twice the minimum.
6. Click **OK**.

The pile plot is configured for viewing a single channel of data. The plot can be positioned and resized using the mouse. When you animate or track data the plot will look similar to this:

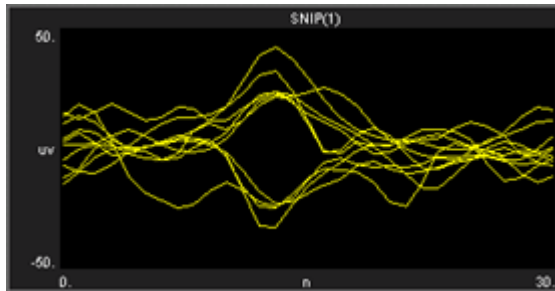

After a single channel pile plot has been created, the settings can be quickly modified for multi-channel viewing.

To modify a pile plot to view multiple channels of data:

1. Double-click the plot to display the **Setup Properties** dialog box.
2. Enter **0** in the **Source Channel** box to ensure that all channels are available for viewing.
3. Select the **Multi View Enabled** check box.
4. In the **Num Views** box, enter the total number of views required to see all available channels of data in the multi view. This number will typically be the number of channels of data acquired. By default channels will be displayed beginning with channel 1.
5. Enter the number of columns to display in the **Num Columns** box.
6. Click **OK**.

When you animate or track data the plot will look similar to this:

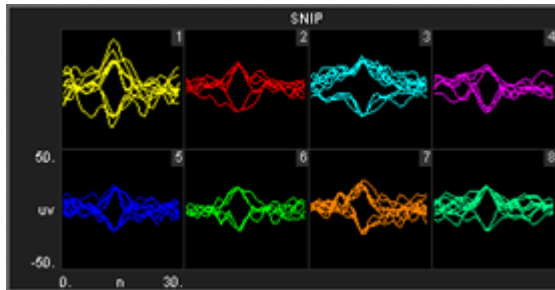

After a multi-channel pile plot has been created, the settings can be quickly modified for viewing a range of channels.

To modify a pile plot to view a range of channels:

1. Double-click the plot to display the **Setup Properties** dialog box.
2. Enter the total number of channels of data to be viewed in the **Num Views** box.
By default channels will be displayed beginning with channel 1. To display multiple channels beginning with another channel, modify the index offset.
3. To modify the index offset value, click the **Parameter Group** box, and click **Multi View**.
4. In the **View Index Offset** box, enter the number of channels to offset.

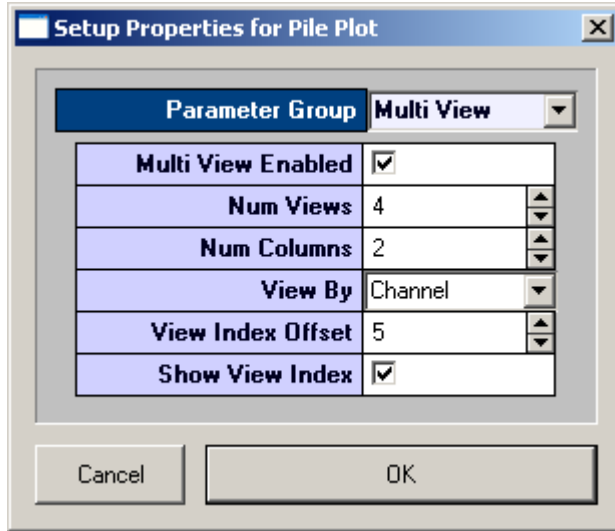

For example, to begin viewing from channel 6, enter an Index Offset value of 5. The plot will begin with channel 6 and display the next sequential channels to equal the number entered in the Num Views box.

5. Click **OK**.

When you animate or track data the plot will look similar to this:

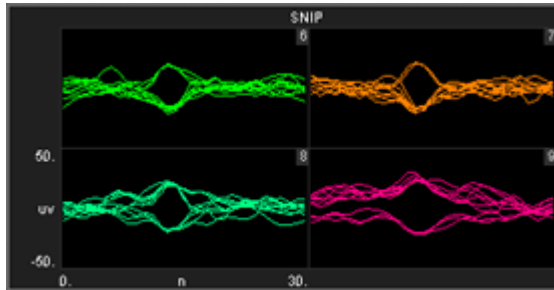

Creating Scroll Plots

Scroll plots provide a useful means of looking at continuous data. Data is presented in segments called scrolls. Looking at one scroll after another gives an effect similar to an oscilloscope or EKG. In a scroll plot the Y-axis is voltage and the X-axis is the record size.

To quickly create a scroll plot for single channel of the selected data:

1. Drag a data event from the **Tank Select** window to the grid area.
The **Select Plot Type** box opens.

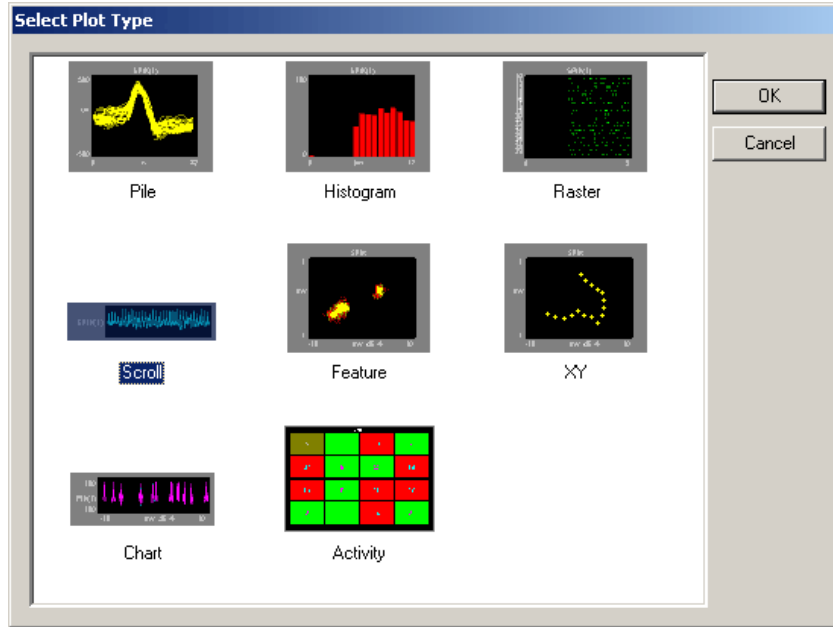

2. Click **Scroll**.

The scroll plot is added to the grid area and the Setup Properties dialog box opens with the most commonly used settings for the scroll plot displayed.

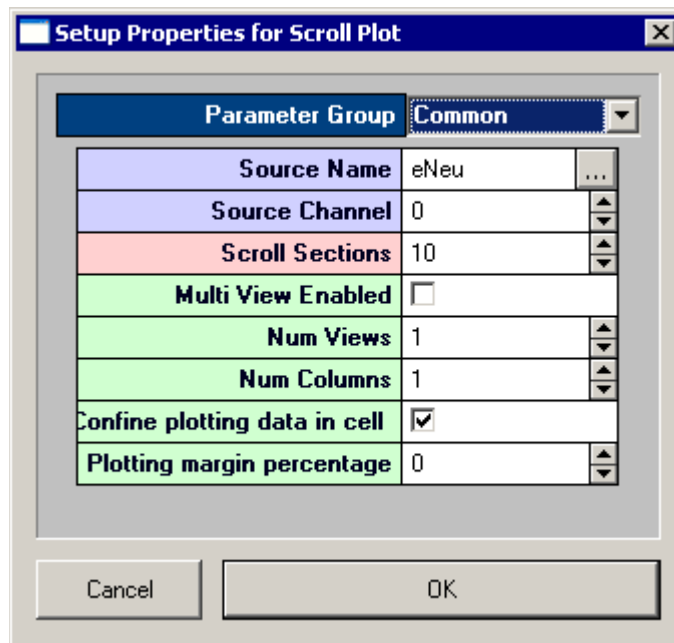

Settings groups include:

- Common - pg. 266
- Data Source - pg. 267
- Behavior - pg. 264
- Multi View - pg. 260
- Refresh Control - pg. 261
- Scaling - pg. 261
- X-Axis Setup - pg. 262
- Y-Axis Setup - pg. 262
- Appearance - pg. 195
- Margins - pg. 191
- Colors - pg. 260

Related settings are grouped together by color. Other settings are available by clicking the **Parameter Group** box and selecting a **settings group**.

3. Enter the desired channel number in the **Source Channel** box. Channel information is available in the corresponding OpenWorkbench file.
4. Enter the desired number of scrolls, or data segments, to be displayed.
5. Click **OK**.

The scroll plot is configured for viewing a single channel. The plot can be positioned and resized using the mouse. When you animate or track data the plot will look something like this:

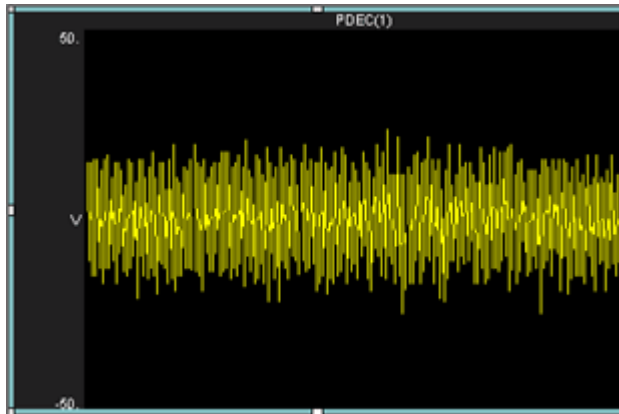

After a single channel scroll plot has been created, the settings can be quickly modified for multi-channel viewing.

To modify a scroll plot to view multiple channels of data:

1. Double-click the plot to display the **Setup Properties** dialog box.
2. Enter **0** in the Source Channel box to ensure that all channels are available for viewing.
3. Enter the desired number of scrolls, or data segments, to be displayed.
4. Select the **Multi View Enabled** check box.
5. In the **Num Views** box, enter the total number of views required to see all available channels of data in the multi view. This number will typically be the number of channels of data acquired. By default channels will be displayed beginning with channel 1.
6. Enter the number of columns to display in the **Num Columns** box. Leave this value set to 1 to see one channel per row.
7. Click **OK**.

After a multi-channel scroll plot has been created, the settings can be quickly modified for viewing a range of channels.

To modify a scroll plot to view a range of channels:

1. Double-click the plot to display the **Setup Properties** dialog box.
2. Enter the total number of channels of data to be viewed in the **Num Views** box.
By default channels will be displayed beginning with channel 1. To display multiple channels beginning with another channel, modify the index offset.
3. To modify the index offset value, click the **Parameter Group** box, and click **Multi View**.
4. In the **View Index Offset** box, enter the number of channels to offset.
For example, to begin viewing from channel 5, enter an Index Offset value of 4. The plot will begin with channel 5 and display the next sequential channels to equal the number entered in the Num Views box.
5. Click **OK**.

When you animate or track data the plot will look like similar to this:

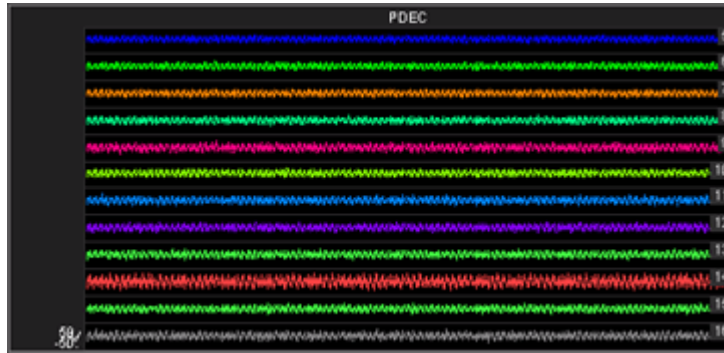

Creating Histograms

Histograms use time stamped values from a variety of data Stores for graphic presentation. The most common of these are snippets, but lists and even scalars can be included as long as a time stamp is part of the acquired value. Users set up the bin size (size of time divisions for sorting the time stamps) and the parameters for refreshing the plot.

A common plot in neurophysiology is the peristimulus histogram, or PSTH. This plot shows the distribution of spike times after a stimulus has been presented. Another plot might show spike times for a particular epoch event such as a signal of particular intensity and a final plot might compare spike patterns across channels over the entire experiment.

Histogram plots in OpenScope show the distribution of waveform time stamps over a set time span. Histogram plots can show additive changes over a set time scale or they can be refreshed over a set range. In addition, the plots can refresh (start from zero) at each epoch or on changes in an epoch (such as a change in the intensity of a stimulus).

This view provides a good visual representation of how waveform time stamps are distributed from the start of a stimulus.

To quickly create a histogram plot of for a single channel of the selected data:

1. Drag a data event from the **Tank Select** window to the grid area.
The **Select Plot Type** box opens.

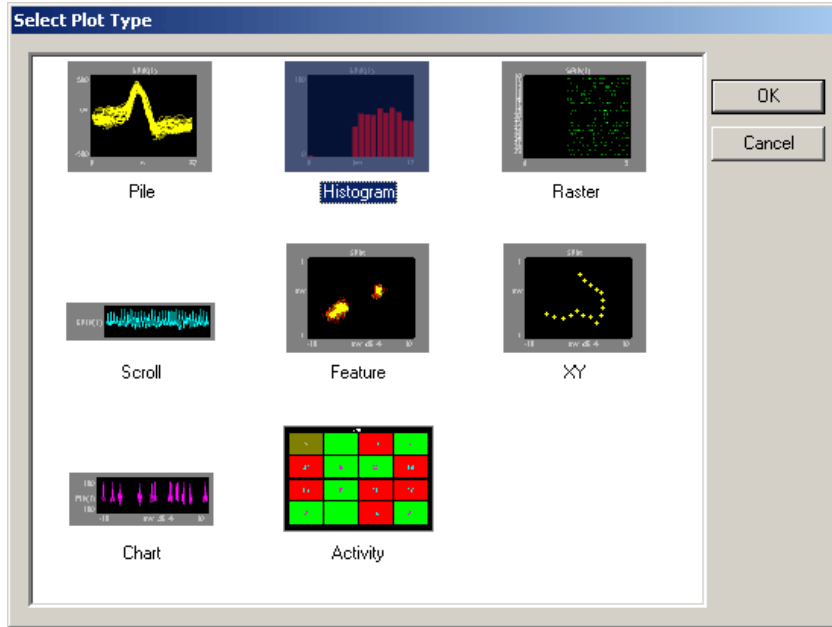

2. Click **Histogram**.

The histogram plot is added to the grid area and the Setup Properties dialog box opens with the most commonly used settings for the histogram plot displayed.

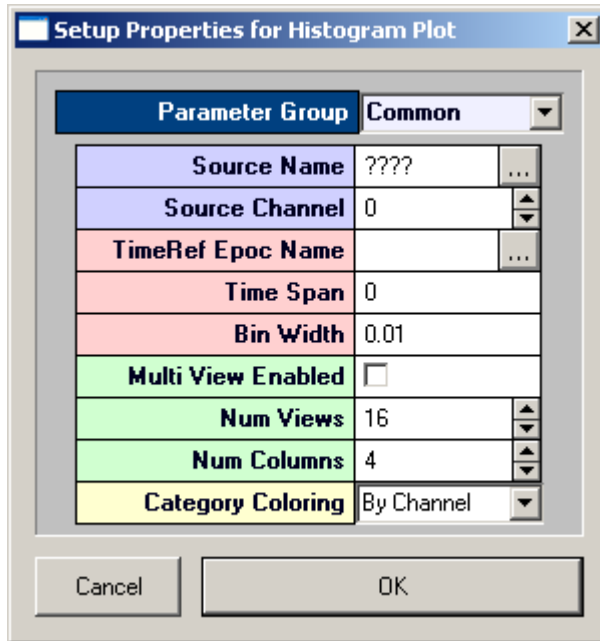

Settings groups include:

- Common - pg. 265
- Data Source - pg. 267
- Behavior - pg. 263
- Multi View - pg. 260
- Refresh Control - pg. 261
- Scaling - pg. 261
- X-Axis Setup - pg. 262
- Y-Axis Setup - pg. 262
- Appearance - pg. 195
- Margins - pg. 191
- Colors - pg. 260

Related settings are grouped together by color. Other settings are available by clicking the **Parameter Group** box and selecting a **settings group**.

3. Enter the desired channel number in the **Source Channel** box. Channel information is available in the corresponding OpenWorkbench file. Channel selection is affected by the Index value on the Devices page and by the Store Chan Offset value on the Stores page.
4. In the **TimeRef Epoc Name** box, select an epoch, or indexed, event. This must be selected to update the histogram.
5. In the **Time Span** box enter the desired time span. This might be set to the length of a stimulus, for example. In the Time Span box the time span can be fixed by the user or left

set to 0 to respect the TRef duration. If the epoch is a stimulus this will allow you to see how waveform times are distributed from the start of the stimulus.

- In the **Bin Width** box, enter the bin width. The bin width should relate to the distribution pattern of the time stamped signals. For a PSTH this might mean that the bin width should be a couple of milliseconds, for patterns of evoked potentials it could be much larger.
- Click **OK**.

The histogram plot is configured for viewing a single channel. The plot can be positioned and resized using the mouse. When you animate or track data the plot will look similar to this:

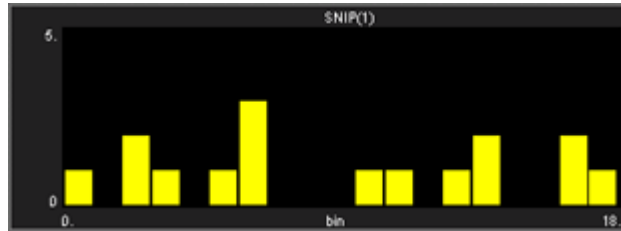

After a single channel histogram plot has been created, the settings can be quickly modified for multi-channel viewing.

To modify a histogram plot to view multiple channels of data:

- Double-click the plot to display the **Setup Properties** dialog box.
- Enter **0** in the Source Channel box to ensure that all channels are available for viewing.
- Select the **Multi View Enabled** check box.
- In the **Num Views** box, enter the total number of views required to see all available channels of data in the multi view. This number will typically be the number of channels of data acquired. By default channels will be displayed beginning with channel 1.
- Enter the number of columns to display in the **Num Columns** box. Depending on the design of your experiment you might want to view a pattern that is representative of the physical or logical distribution of the channels. For example, if you had electrodes placed in a 4 x 4 grid around the head then it would be useful to see that pattern in OpenScope. Similarly, if you had electrodes in a linear pattern you might want to have either 1 column or 16 columns.
- Click **OK**.

When you animate or track data the plot will look similar to this:

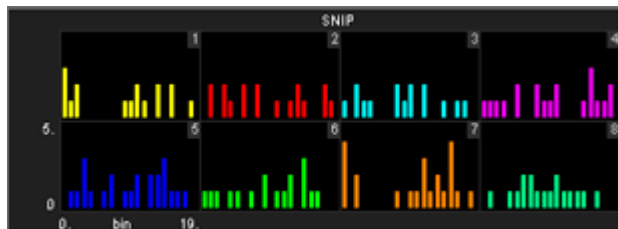

After a multi-channel histogram plot has been created, the settings can be quickly modified for viewing a range of channels.

To modify a histogram plot to view a range of channels:

- Double-click the plot to display the **Setup Properties** dialog box.
- Enter the total number of channels of data to be viewed in the **Num Views** box.

By default channels will be displayed beginning with channel 1. To display multiple channels beginning with another channel, modify the index offset.

3. To modify the index offset value, click the **Parameter Group** box, and click **Multi View**.
4. In the **View Index Offset** box, enter the number of channels to offset.

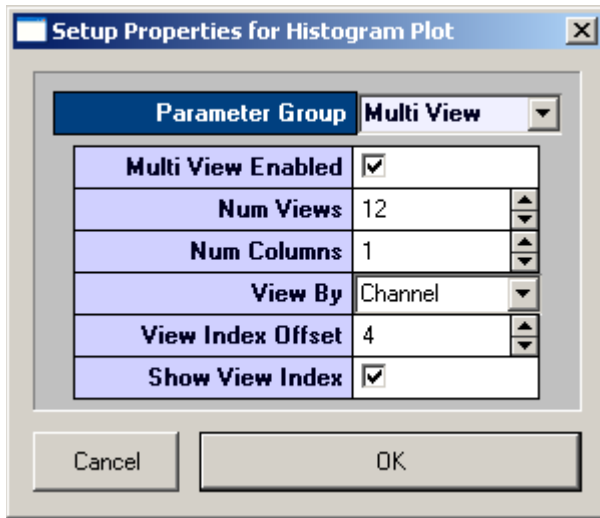

For example, to begin viewing from channel 5, enter an Index Offset value of 4. The plot will begin with channel 5 and display the next sequential channels to equal the number entered in the Num Views box.

5. Click **OK**.

After a multi channel histogram plot has been created, the settings can be quickly modified to view by sort code.

To modify a multi-channel histogram plot to view by sort code:

1. Double-click the plot to display the **Setup Properties** dialog box.
2. Click the **Parameter Group** box, and click **Multi View**.
3. In the **View By** box, select **Sort Code** from the drop down list.
4. Update the **Num Views** and **View Index Offset** values as needed.
5. Click **OK**.

Creating Raster Plots

Raster plots provide a useful means of looking at time stamped values or waveforms that are not continuous, such as snippets. The time stamps of the snippets are represented by dots plotted in rows. Each row represents an epoch, or indexed, event. In a raster plot the Y-axis is indexed event values and the X-axis is time stamp values.

This view provides a good visual representation of when snippets occurred for an indexed event. Raster plots are an excellent way of detecting subtle changes in the timing of waveforms across channels.

To quickly create a raster plot for a single channel of the selected data:

1. Drag a data event from the **Tank Select** window to the grid area.
The **Select Plot Type** box opens.

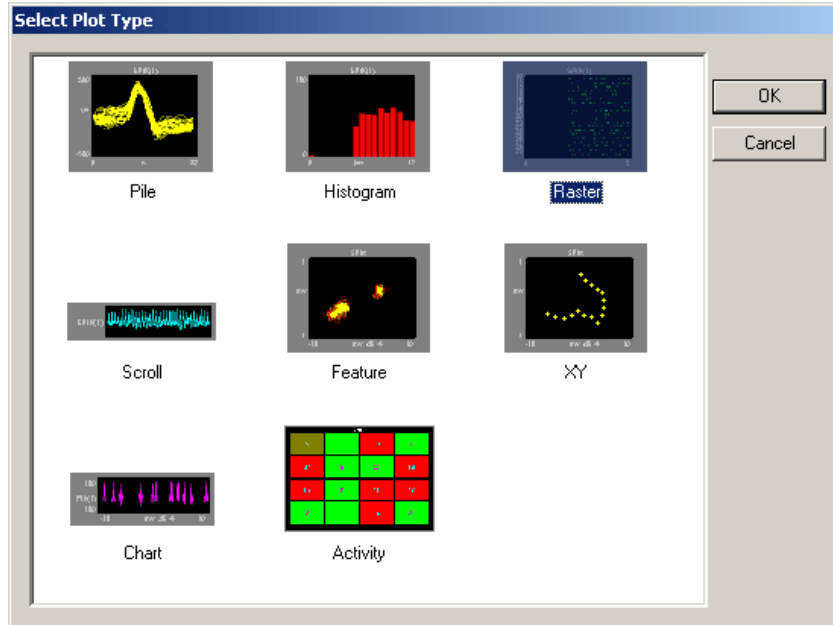

2. Click **Raster**.

The raster plot is added to the grid area and the Setup Properties dialog box opens with the most commonly used settings for the raster plot displayed.

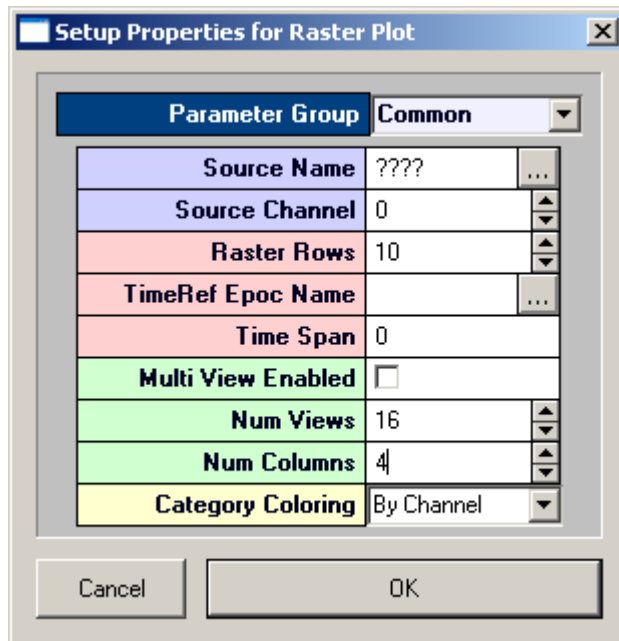

Settings groups include:

- Common - pg. 266
- Data Source - pg. 267
- Behavior - pg. 263
- Multi View - pg. 260
- Refresh Control - pg. 261
- X-Axis Setup - pg. 262
- Y-Axis Setup - pg. 262
- Appearance - pg. 195
- Margins - pg. 191
- Colors - pg. 260

Related settings are grouped together by color. Other settings are available by clicking the **Parameter Group** box and selecting a **settings group**.

3. Enter the desired channel number in the **Source Channel** box. Channel information is available in the corresponding OpenWorkbench file.
4. Enter the desired number of rows to be displayed in the **Raster Rows** box.
5. In the **TimeRef Epoc Name** box, select an epoch, or indexed, event. This will define the Y-Axis.

6. In the **Time Span** box, enter a time stamp value for the maximum value of the X-axis. This value should usually be the time span of the indexed event, according to the time stamp.
7. Click **OK**.

The raster plot is configured for viewing a single channel. The plot can be positioned and resized using the mouse. When you animate or track data the plot will look like this:

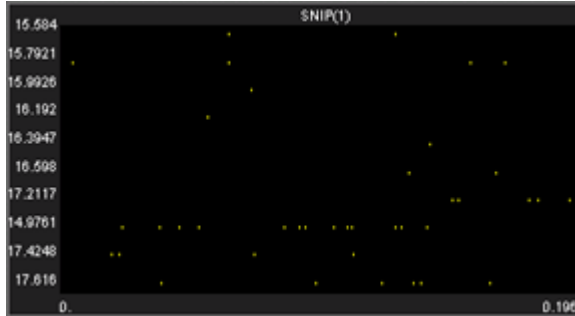

To modify a raster plot to view multiple channels of data:

1. Double-click the plot to display the **Setup Properties** dialog box.
2. Enter **0** in the **Source Channel** box to ensure that all channels are available for viewing.
3. In the **Raster Rows** box, enter the desired number of rows to be displayed. Enter 1 to view one row per channel for a clear comparison across channels for a single event value.
4. Select the **Multi View Enabled** check box.
5. In the **Num Views** box, enter the total number of views required to see all available channels of data in the multi view. This number will typically be the number of channels of data acquired. By default channels will be displayed beginning with channel 1.
6. Enter the number of columns to display in the **Num Columns** box.
7. Click **OK**.

To modify a raster plot to view a range of channels:

1. Double-click the plot to display the **Setup Plot** dialog box.
2. Enter the total number of channels of data to be viewed in the **Num Views** box.
3. By default channels will be displayed beginning with channel 1. To display multiple channels beginning with another channel, modify the index offset.
4. To modify the index offset value, click the **Parameter Group** box, and click **Multi View**.
5. In the **View Index Offset** box, enter the number of channels to offset.
6. For example, to begin viewing from channel 5, enter an Index Offset value of 4. The plot will begin with channel 5 and display the next sequential channels to equal the number entered in the Num Views box.
7. Click **OK**.

To modify a multi-channel raster plot to view by sort code:

1. Double-click the plot to display the **Setup Properties** dialog box.
2. Click the **Parameter Group** box, and click **Multi View**.
3. In the **View By** box, select **Sort Code** from the drop down list.
4. Update the **Num Views** and **View Index Offset** values as needed.
5. Click **OK**.

Creating XY Plots

XY plots provide a useful means of looking changes in two continuously varying values. In OpenScope, the Y-axis and the X-axis are selected from available data events. The XY plot can be used to plot positional information such as XY coordinates for an animal moving in a tank or it can be used to plot data from an eye or head tracker.

This type of plot can also be used when the study subject needs to be in a specific position for accurate data acquisition. The XY plot can help the user to quickly determine if there were any significant changes in the subject's position such as the head position relative to the position of a sound or visual stimulus.

To quickly create an XY plot for a single channel of the selected data:

1. Drag a data event from the **Tank Select** window to the grid area.

The **Select Plot Type** box opens.

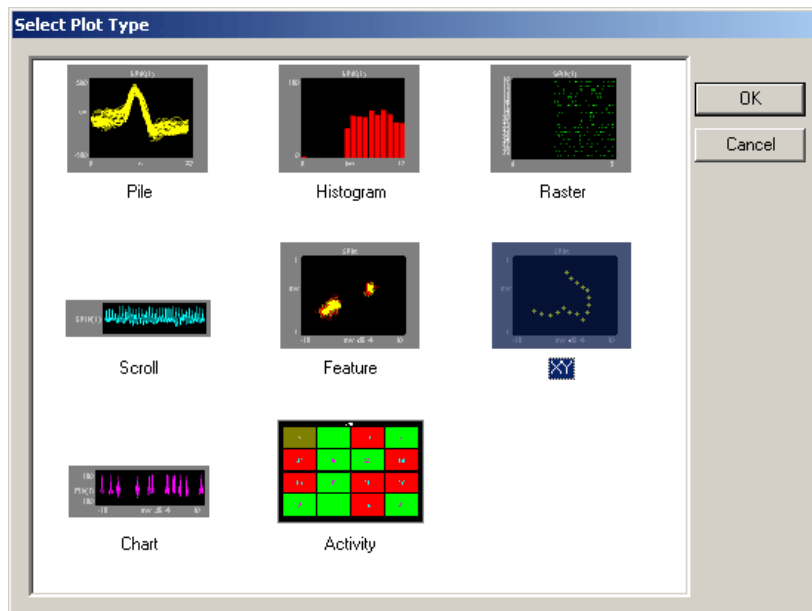

2. Click **XY**.

The XY plot is added to the grid area and the Setup Properties dialog box opens with the most commonly used settings for the feature plot displayed.

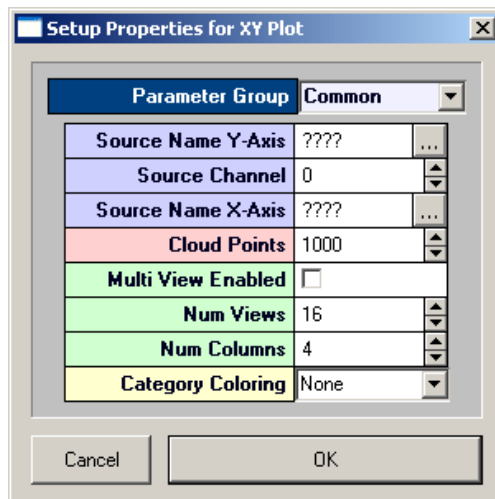

Settings groups include:

- Common - pg. 267
- Data Source - pg. 267
- Behavior - pg. 264
- Multi View - pg. 260
- Scaling - pg. 261
- Refresh Control - pg. 261
- X-Axis Setup - pg. 262
- Y-Axis Setup - pg. 262
- Appearance - pg. 195
- Margins - pg. 191
- Colors - pg. 260

Related settings are grouped together by color. Other settings are available by clicking the **Parameter Group** box and selecting a **settings group**.

3. Enter the desired channel number in the **Source Channel** box. Channel information is available in the corresponding OpenWorkbench file.
4. Click the **Source Name X-Axis** box to select the desired data event for the X-axis. An event selection box opens.
5. Click the desired data event to select it, and click **OK**.
6. In the **Cloud Points** box, enter the minimum number of points to be displayed. The plot will refresh when the plot reaches twice the value set.
7. Click **OK**.

The XY plot is configured for viewing a single channel of data. The plot can be positioned and resized using the mouse.

After a single channel XY plot has been created, the settings can be quickly modified for multi-channel viewing.

To modify a XY plot to view multiple channels of data:

1. Double-click the plot to display the **Setup Properties** dialog box.
2. Enter **0** in the **Source Channel** box to ensure that all channels are available for viewing.
3. Select the **Multi View Enabled** check box.
4. In the **Num Views** box, enter the total number of channels of data to be viewed.
By default channels will be displayed beginning with channel 1. To display multiple channels beginning with another channel, modify the index offset.
5. To modify the index offset value, click the **Parameter Group** value box, and click **Multi View**.
6. In the **View Index Offset** box, enter the number of channels to offset.
7. For example, to begin viewing from channel 5, enter an Index Offset value of 4. The plot will begin with channel 5 and display the next sequential channels to equal the number entered in the Num Views box.
8. Click **OK**.

Creating Feature Plots

Feature plots compare two waveform properties, such as the first and second peak voltages of two candidate spikes. They are ideal for determining how many unique waveforms are present in a signal.

In OpenScope the feature plot has been designed for examining patterns of spike waveforms. The plot works best when viewing time stamped waveforms that are not continuous. In OpenEx this type of data is also called snippet data. Although other waveforms can be viewed, plotting complex waveforms with many points will require intensive amounts of computer time.

While the default feature of the Y-axis is the voltage of the second peak and the X-axis is the voltage of the first peak, the X-axis and Y-axis features can be selected from a drop down list in the Setup Properties dialog box. By generating multiple feature plots, each with different XY characteristics, it is possible to differentiate several spike types. This information can then be used to do offline or online spike sorting.

To quickly create a feature plot for a single channel of the selected data:

1. Drag a data event from the **Tank Select** window to the grid area.
The **Select Plot Type** box opens.

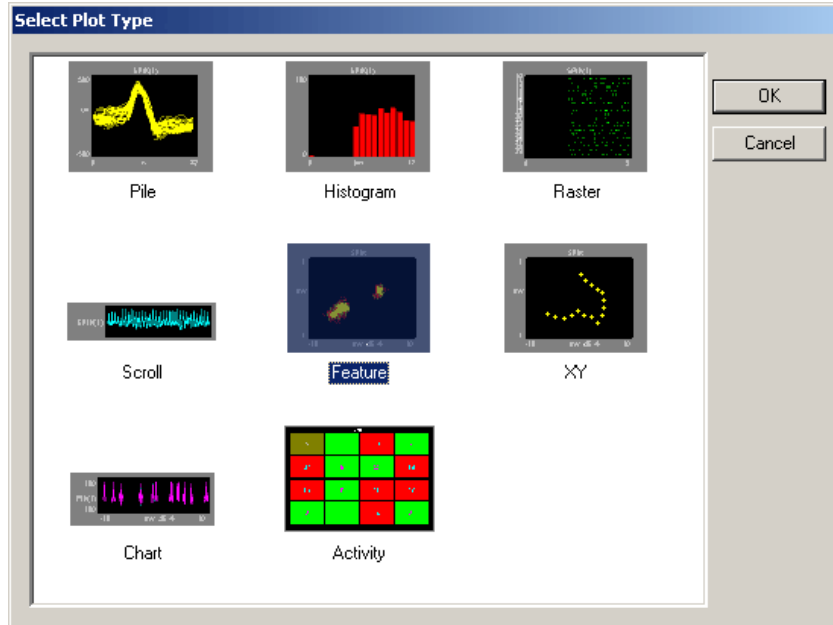

2. Click **Feature**.

The feature plot is added to the grid area and the Setup Properties dialog box opens with the most commonly used settings for the feature plot displayed.

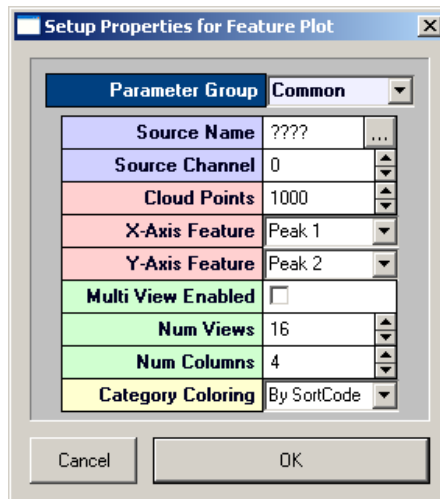

Settings groups include:

- Common - pg. 265
- Data Source - pg. 267
- Behavior - pg. 262
- Multi View - pg. 260
- Refresh Control - pg. 261
- Scaling - pg. 261
- X-Axis Setup - pg. 262
- Y-Axis Setup - pg. 262
- Appearance - pg. 195
- Margins - pg. 191
- Colors - pg. 260
- Filtering - pg. 260

Related settings are grouped together by color. Other settings are available by clicking the **Parameter Group** box and selecting a settings group.

3. Enter the desired channel number in the **Source Channel** box. Channel information is available in the corresponding OpenWorkbench file.
4. In the **Cloud Points** box, enter the minimum number of points to be displayed. The plot will refresh when the plot reaches twice the value set.
5. If desired, select an X-axis and/or Y-axis feature from the drop down menus in the corresponding value box. Select from Total Amplitude, Peak 1, Peak 2, Peak to Peak Time, or Area.
6. By default, Category Coloring is set to By SortCode and a different color will automatically be assigned to each sort code. When data is not associated with a sort code it will be assigned a gray color. If sort codes are not present in the data, change this setting to **None** to display data points in a brighter color for easier viewing.

7. Click **OK**.

The feature plot is configured for viewing a single channel of data. The plot can be positioned and resized using the mouse.

After a single channel feature plot has been created, the settings can be quickly modified for multi-channel viewing.

To modify a feature plot to view multiple channels of data:

1. Double-click the plot to display the **Setup Properties** dialog box.
2. Enter **0** in the **Source Channel** box to ensure that all channels are available for viewing.
3. Select the **Multi View Enabled** check box.
4. In the **Num Views** box, enter the total number of views required to see all available channels of data in the multi view. This number will typically be the number of channels of data acquired. By default channels will be displayed beginning with channel 1.
5. Enter the number of columns to display in the **Num Columns** box.
6. By default, **Category Coloring** is set to **By SortCode** and a different color will automatically be assigned to each sort code. When data is not associated with a sort code it will be assigned a gray color. If sort codes are not present in the data, change this setting to **By Channel** to display data points in brighter colors for easier viewing.
7. Click **OK**.

After a multi channel feature plot has been created, the settings can be quickly modified for viewing a range of channels.

To modify a scroll plot to view a range of channels:

1. Double-click the plot to display the **Setup Properties** dialog box.
2. Enter the total number of channels of data to be viewed in the **Num Views** box.
3. By default channels will be displayed beginning with channel 1. To display multiple channels beginning with another channel, modify the index offset.
4. To modify the index offset value, click the **Parameter Group** value box, and click **Multi View**.
5. In the **View Index Offset** box, enter the number of channels to offset.

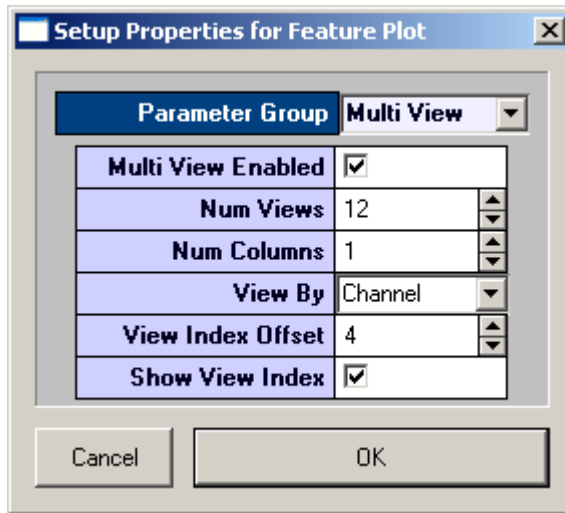

For example, to begin viewing from channel 5, enter an Index Offset value of 4. The plot will begin with channel 5 and display the next sequential channels to equal the number entered in the Num Views box.

6. Click **OK**.

Creating Chart Plots

Chart plots are an excellent way of graphing time stamped waveform data such as spike snippets. Unlike raster plots that only show the position of the time stamp over a narrow range in the block, the chart plot shows the snippet waveform and its exact position in the block of data.

In a chart plot the Y-axis is voltage and the X-axis is time in seconds. When the scale of the X-axis is contracted the position of a snippet along the X-axis clearly identifies when in time the snippets occurred and patterns of occurrence over time are emphasized. As the scale of the X-axis is expanded the shape of the waveform becomes more visible.

To quickly create a chart plot for single channel of the selected data:

1. Drag a data event from the **Tank Select** window to the grid area.

The **Select Plot Type** box opens.

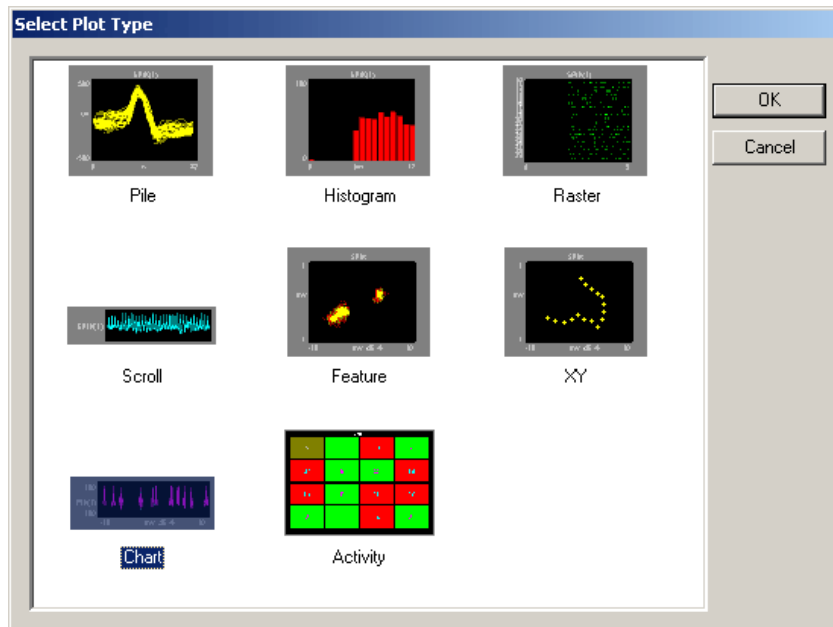

2. Click **Chart**.

The chart plot is added to the grid area and the Setup Properties dialog box opens with the most commonly used settings for the chart plot displayed.

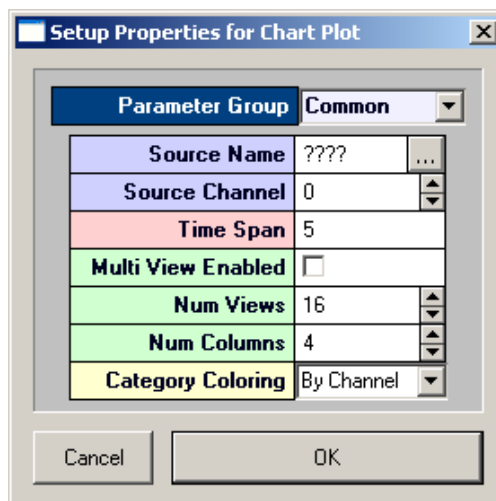

Settings groups include:

- Common - pg. 264
- Data Source - pg. 267
- Behavior - pg. 262
- Multi View - pg. 260
- Refresh Control - pg. 261
- Scaling - pg. 261
- X-Axis Setup - pg. 262
- Y-Axis Setup - pg. 262
- Appearance - pg. 195
- Margins - pg. 191
- Colors - pg. 260

Related settings are grouped together by color. Other settings are available by clicking the **Parameter Group** box and selecting a **settings group**.

3. Enter the desired channel number in the **Source Channel** box. Channel information is available in the corresponding OpenWorkbench file.
4. Enter the desired **Time Span** in seconds, to be displayed on the X-axis.
5. Click **OK**.

The chart plot is configured for viewing a single channel. The plot can be positioned and resized using the mouse. When you animate or track data the plot will look like this:

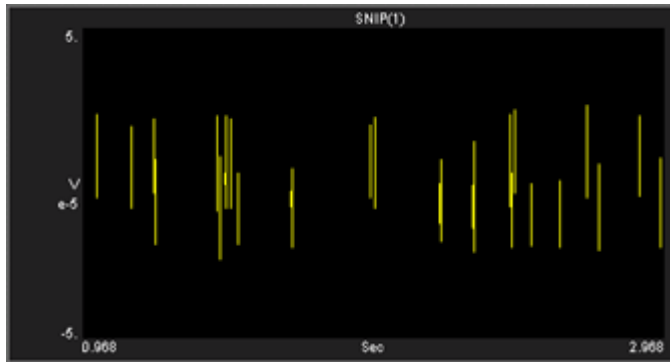

To quickly expand the X-axis scale and view a snippet waveform, hold down the SHIFT key, point to the snippet, and drag to the right.

After a single channel chart plot has been created, the settings can be quickly modified for multi-channel viewing.

To modify a chart plot to view multiple channels of data:

1. Double-click the plot to display the **Setup Properties** dialog box.
2. Enter **0** in the **Source Channel** box to ensure that all channels are available for viewing.
3. Enter the desired **Time Span** in second, to be displayed on the X-axis.
4. Selecting a shorter time span will improve animation performance for multiple channels. When viewing the chart, the time span can be shortened or expanded by pressing and holding the SHIFT key, and dragging right or left with the mouse.
5. Select the **Multi View Enabled** check box.
6. In the **Num Views** box, enter the total number of views required to see all available channels of data in the multi view. This number will typically be the number of channels of data acquired. By default channels will be displayed beginning with channel 1.
7. Enter the number of columns to display in the **Num Columns** box. Leave this value set to 1 to see one channel per row.
8. Click **OK**.

When you animate or track data the plot will look like similar to this:



After a multi-channel chart plot has been created, the settings can be quickly modified for viewing a range of channels.

To modify a chart plot to view a range of channels:

1. Double-click the plot to display the **Setup Properties** dialog box.
2. Enter the total number of channels of data to be viewed in the **Num Views** box.
3. By default channels will be displayed beginning with channel 1. To display multiple channels beginning with another channel, modify the index offset.
4. To modify the index offset value, click the **Parameter Group** box, and click **Multi View**.
5. In the **View Index Offset** box, enter the number of channels to offset.

For example, to begin viewing from channel 5, enter an Index Offset value of 4. The plot will begin with channel 5 and display the next sequential channels to equal the number entered in the Num Views box.

6. Click **OK**.

Creating Activity Plots

Activity plots are used to view the amount of spike (or other) activity occurring on a given channel or group of channels. Activity plots make it easy to view spike counts or to compare spike rates between acquisition channels. Activity plots use time stamped values from a variety of data Stores for graphic presentation. The most common of these are snippets, but lists and even buffers can be included as long as a time stamp is part of the acquired value. Users define the minimum and maximum value to be displayed, assign a color to minimum and maximum, and choose a parameter for refreshing the plot. As the plot is animated the color of an activity cell varies in intensity across a range corresponding to the minimum and maximum defined values.

To quickly create an activity plot for combined data for all channels of the selected data:

1. Drag a data event from the **Tank Select** window to the grid area.

The **Select Plot Type** box opens.

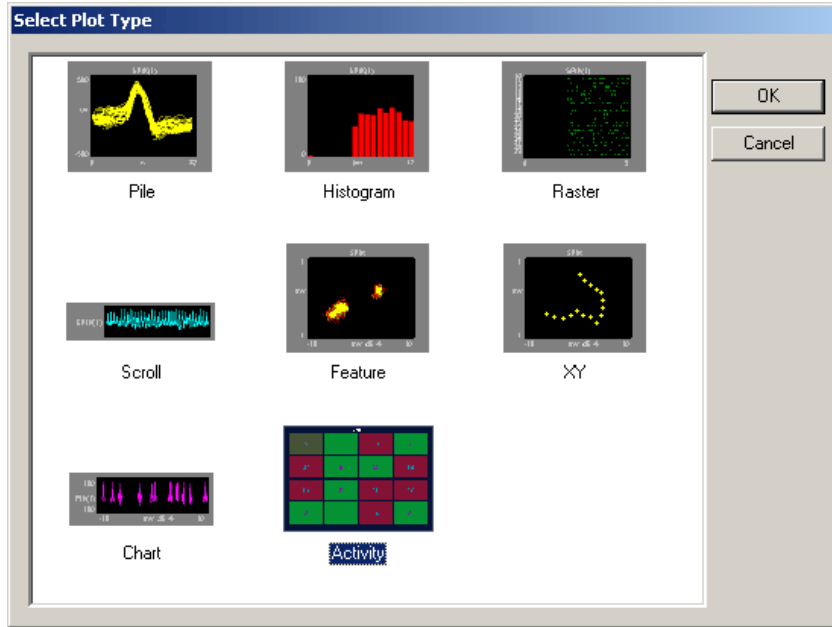

2. Click **Activity**.

The activity plot is added to the grid area and the Setup Properties dialog box opens with the most commonly used settings for the activity plot displayed.

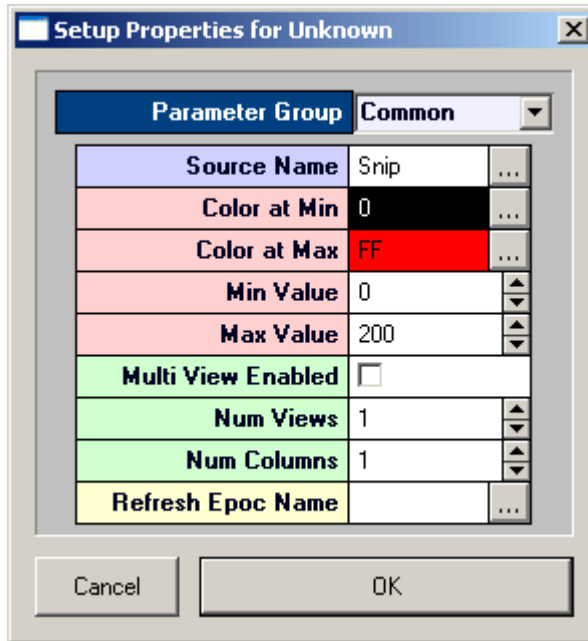

Settings groups include:

- Common - pg. 264
- Data Source - pg. 267
- Behavior - pg. 262
- Multi View - pg. 260
- Refresh Control - pg. 261
- Appearance - pg. 195
- Margins - pg. 191
- Colors - pg. 260

Related settings are grouped together by color. Other settings are available by clicking the **Parameter Group** box and selecting a settings group.

3. In the **Refresh Epoch Name** box, select an epoch, or indexed, event. This must be selected to update the plot.
4. In the **Max Value** box enter a number at least as large as the maximum activity (number of spikes) anticipated.
5. Click **OK**.

The Activity plot is configured for viewing combined data for all channels. The plot can be positioned and resized using the mouse. When you animate or track data the plot will look similar to this:



**Combined Data Activity Plot
with Activity Near Minimum Value**

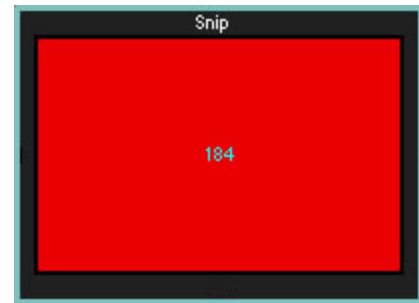

**Combined Data Activity Plot
with Activity Near Maximum Value**

After a combined data activity plot has been created, the settings can be quickly modified for multi-channel viewing.

To modify an activity plot to view multiple channels of data:

1. Double-click the plot to display the **Setup Properties** dialog box.
2. Select the **Multi View Enabled** check box.
3. In the **Num Views** box, enter the total number of views required to see all available channels of data in the multi view. This number will typically be the number of channels of data acquired. By default channels will be displayed beginning with channel 1.
4. Enter the number of columns to display in the **Num Columns** box. Depending on the design of your experiment you might want to view a pattern that is representative of the physical or logical distribution of the channels. For example, if you had electrodes placed in a 4 x 4 grid around the head then it would be useful to see that pattern in OpenScope. Similarly, if you had electrodes in a linear pattern you might want to have either 1 column or 16 columns.
5. Click **OK**.

When you animate or track data the plot will look similar to this:

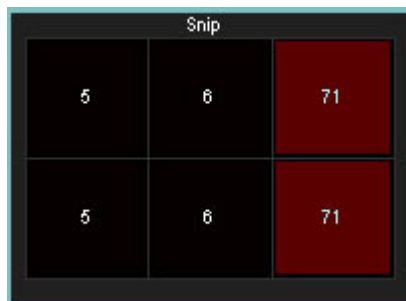

After a multi channel activity plot has been created, settings can be modified to view by sort code.

To modify a multi-channel activity plot to view by sort code:

1. Double-click the plot to display the **Setup Properties** dialog box.
2. Click the Parameter Group box, and click **Multi View**.
3. In the **View By** box, select **Sort Code** from the drop down list.
4. Update the **Num Views** and **View Index Offset** values as needed.
5. Click **OK**.

Plot Settings Reference

About the Plot Settings Reference

The Plot Settings Reference corresponds to a parameter group in the properties dialog box.

How To Find These Settings

Settings in this reference are available in the properties dialog boxes.

To open the properties dialog box for a plot, double-click the plot in the grid area of OpenScope.

Colors Parameter Group

Category Coloring: Set how the trace colors will be applied.

None: The color set in the Trace Color value box will be applied to all traces.

By Channel: The color of traces will be automatically assigned by channel.

By Sortcode: The color of traces will be automatically assigned by sortcode.

Trace (or Dot) Color: Select the trace color from a color palette. This selected color is only used if Category Coloring is set to None.

Plot Border Color: Select the plot border color from a color palette.

Foreground Color: Select the foreground color from a color palette.

Background Color: Select the trace color from a color palette.

Font Color: Select the font color from a color palette.

MultiChannel Grid Color: Select the multi-channel grid color from a color palette.

Filtering Parameter Group

Filter On: Select the check box to enable an FIR filter algorithm using FIR parameters provided in CoefB0-B4. Clear the check box to disable the filter.

CoefB0: Type a coefficient.

CoefB1: Type a coefficient.

CoefB2: Type a coefficient.

CoefB3: Type a coefficient.

CoefB4: Type a coefficient.

Multi View Parameter Group

Multi-View Enabled: Select the check box to view each channel, or sort code, of data in an individual plot.

Num Views: Set the number of channels or sorts to view in a multi-view plot. If data contains more than 16 channels or sorts the value must be increased to show all data.

Num Columns: Set the number of columns in which multi-view plots are arranged.

View By: Channel or Sort. Sorts are generated in the RpvdsEx circuit.

View Index Offset: Starting channel or sort is the View Index Offset value +1.

For example: To begin viewing data with channel 3, set the View Index Offset value at 2.

Show View Index: Index is Channel or Sort Code and is determined by the View By value.

Refresh Control Parameter Group

Refresh Epoch Name: Define the refresh epoch, or indexed event. Click the value box to view a list of events. Valid choices are preceded by an  epoch event icon. When a refresh epoch event is defined the plot will be refreshed based on the epoch value according to the settings in the Refresh Control parameter group.

Strobe Epoch Low Range: Set the low value for a range in which the plot will be refreshed according to the defined refresh epoch. Leave at the default value of 0 if a range will not be used.

If the scalar value read from the tank for the defined refresh epoch event is greater than the Strobe Epoch Low Range value then the plot is refreshed. If not, new data is added along with older data.

Strobe Epoch High Range: Set the high value for a range in which the plot will be refreshed according to the defined refresh epoch. Leave at the default value of -1 if a range will not be used.

If the scalar value read from the tank for the defined refresh epoch event is less than the Strobe Epoch High Range value then the plot is refreshed. If not, new data is added along with older data.

Refresh on Change: Select the check box to refresh the plot when the scalar value associated with the defined refresh epoch changes.

This setting can be used with the range settings to create a range in which the plot will be refreshed on change.

Refresh Period: Set a time value for the refresh period in seconds.

Scaling Parameter Group

X / Y-Axis Range: Type a value to set the range for the X / Y - axis.

X / Y-Axis Symmetry: Select the check box to ensure that a symmetrical X/Y-axis range will be displayed. This is ideal for signals that are expected to be symmetrical.

Auto Scale: The plot can be set to automatically scale during animation to ensure that the data can always be viewed in a convenient scale.

None: Auto Scale is turned off.

Active: The scale of the plot is automatically adjusted to ensure all values can be shown on the plot.

Smart: The scale of the plot is automatically adjusted to ensure values can be shown on the plot only during the first 3 seconds.

Up-Scale Hist.: When Auto Scale is used, this value sets the number of points above the Y-axis range that the signal must reach before scaling will occur.

Down-Scale Hist.: When Auto Scale is used, this value sets the number of points below half of the Y-axis range a signal must fall before scaling will occur.

X-Axis Setup Parameter Group

Show X Labels: Select the check box to display a unit label for the x-axis. Clear the check box to hide the x-axis label.

X-Axis Unit: Set name for units that will appear as part of the plot label.

X-Axis Units Factor: Define a multiplication factor to convert x-axis units to valid value for the units label.

X-Axis Offset: Define the starting value for the x-axis.

Y-Axis Setup Parameter Group

Show Y Labels: Select the check box to display a unit label for the y-axis. Clear the check box to hide the y-axis label.

Y-Axis Units: Set name for units that will appear as part of the plot label.

Y-Axis Units Factor: Define a multiplication factor to convert y-axis units to valid value for the units label.

Behavior Parameter Group

Activity Behavior Parameters

Color at Min: Select the color to be displayed when activity is at defined Min Value. Color for values between Min and Max Values are generated using a proportional mix of the defined Colors at Min and Max.

Color at Max: Select the color to be displayed when activity is at defined Min Value. Color for values between Min and Max Values are generated using a proportional mix of the defined Colors at Min and Max.

Min Value: Enter the number of spike to be defined as the minimum value, which is represented by the defined Color at Min.

Max Value: Enter the number of spike to be defined as the maximum value, which is represented by the defined Color at Max.

Show Num Trace: Select the check box to display the number of events in the activity cell. Clear the check box to hide the number label.

Chart Behavior Parameters

Time Span: Set the time range, in seconds and according to the time stamp, to be displayed on the X-axis.

Feature Behavior Parameters

Cloud Points: Set the minimum number of points to display. The maximum number of cloud points will be twice the value set. The plot will refresh when the maximum number is reached.

X-Axis Feature: Select from a drop down list. Choices are Peak 1, Peak 2, Peak to Peak Time, and Area.

Y-Axis Feature: Select from a drop down list. Choices are Peak 1, Peak 2, Peak to Peak Time, and Area.

Histogram Behavior Parameters

TimeRef Epoch Name: Defines the epoch, or indexed event, that will be used for the raster rows. Click the value box to view a list of events. Valid choices are preceded by an  epoch event icon.

Respect TRef Duration: When checked the plot's X-axis scale is equal to the duration of the epoch event selected in the TimeRef Epoch Name setting.

TRef Epoch Low Range: Use to set the low value for the X-axis range according to the defined TimeRef epoch event. As data is animated, the next data will only be displayed if the associated epoch event value is greater than or equal to the low range value. Leave at default value of 0 if a range will not be used.

TRef Epoch High Range: Use to set the high value for the X-axis range according to the defined TimeRef epoch event. As data is animated, the next data will only be displayed if the associated epoch event value is less than or equal to the high range value. Leave at default value of -1 if a range will not be used.

Time Span: Define the time span if the Respect TRef Duration check box is cleared. The X-axis will be equal to the value set for Time Span divided by the value set for Bin Width.

Bin Width: Define the Bin Width. The X-axis will be equal to the value set for Time Span divided by the value set for Bin Width.

Pile Behavior Parameters

Pile Depth: Set the minimum number of traces that will be displayed. The maximum number of traces will be twice the value set. The plot will refresh when the maximum number is reached.

Raster Behavior Parameters

Raster Rows: Select the number of rows to display.

TimeRef Epoch Name: Defines the epoch, or indexed event, that will be used for the raster rows. Click the value box to view a list of events. Valid choices are preceded by an  epoch event icon.

Respect TRef Duration: When checked the plot's X-axis scale is equal to the duration of the epoch event selected in the TimeRef Epoch Name setting.

TRef Epoch Low Range: Use to set the low value for the X-axis range according to the defined TimeRef epoch event. As data is animated, the next data will only be displayed if the associated epoch event value is greater than the low range value. Leave at default value of 0 if a range will not be used.

TRef Epoch High Range: Use to set the high value for the X-axis range according to the defined TimeRef epoch event. As data is animated, the next data will only be displayed if the associated epoch event value is less than the high range value. Leave at default value of -1 if a range will not be used.

Time Span: Define the maximum value of the X-axis using a time stamp value if the Respect TRef Duration check box is cleared.

Scroll Behavior Parameters

Scroll Sections: Set the number of sections to display before scrolling.

XY Behavior Parameters

Cloud Points: Set the minimum number of points to display. The maximum number of cloud points will be twice the value set. The plot will refresh when the maximum number is reached.

Common Parameter Group

Activity Common Parameters

Source Name: Select the data event (Store name) from the currently selected tank.

Color at Min: Select the color to be displayed when activity is at defined Min Value. Color for values between Min and Max Values are generated using a proportional mix of the defined Colors at Min and Max.

Color at Max: Select the color to be displayed when activity is at defined Min Value. Color for values between Min and Max Values are generated using a proportional mix of the defined Colors at Min and Max.

Min Value: Enter the number of spike to be defined as the minimum value, which is represented by the defined Color at Min.

Max Value: Enter the number of spike to be defined as the maximum value, which is represented by the defined Color at Max.

Multi View Enabled: Enables multi view for viewing multiple channels. When multi view is enabled, Source Channel should be set to 0.

Num Views: Select the number of channels or sort codes to view. By default, channels will be displayed beginning with channel 1.

Num Columns: Select the number of columns to display.

Refresh Epoch Name: Define the refresh epoch, or indexed event. Click the value box to view a list of events. Valid choices are preceded by an  epoch event icon. When a refresh epoch event is defined the plot will be refreshed based on the epoch value according to the settings in the Refresh Control parameter group.

Chart Common Parameters

Source Name: Select the data event (Store name) from the currently selected tank.

Source Channel: Selects the channel for viewing. To view a single channel of data enter the desired channel number. To view multiple channels set to 0 and enable multi view.

Time Span: Set the time range, in seconds and according to the time stamp, to be displayed on the X-axis.

Multi View Enabled: Enables multi view for viewing multiple channels. When multi view is enabled, Source Channel should be set to 0.

Num Views: Select the number of channels or sort codes to view. By default, channels will be displayed beginning with channel 1.

Num Columns: Select the number of columns to display.

Category Coloring: Selects the trace coloring method. Traces can be seen in a single color (None), one color per channel (By Channel), or one color per sort code (By SortCode).

Feature Common Parameters

Source Name: Select the data event (Store name) from the currently selected tank.

Source Channel: Selects the channel for viewing. To view a single channel of data enter the desired channel number. To view multiple channels set to 0 and enable multi view.

Cloud Points: Set the minimum number of points to display. The maximum number of cloud points will be twice the value set. The plot will refresh when the maximum number is reached.

X-Axis Feature: Select from a drop down list. Choices are Peak 1, Peak 2, Peak to Peak Time, and Area.

Y-Axis Feature: Select from a drop down list. Choices are Peak 1, Peak 2, Peak to Peak Time, and Area.

Multi View Enabled: Enables multi view for viewing multiple channels. When multi view is enabled, Source Channel should be set to 0.

Num Views: Select the number of channels or sort codes to view. By default, channels will be displayed beginning with channel 1.

Num Columns: Select the number of columns to display.

Category Coloring: Selects the trace coloring method. Traces can be seen in a single color (None), one color per channel (By Channel), or one color per sort code (By SortCode).

Histogram Common Parameters

Source Name: Select the data event (Store name) from the currently selected tank.

Source Channel: Selects the channel for viewing. To view a single channel of data enter the desired channel number. To view multiple channels set to 0 and enable multi view.

TimeRef Epoc Name: Define the epoch, or indexed event, that will be used for the vertical bars. Click the value box to view a list of events. Valid choices are preceded by an  strobe/indexed event icon.

Time Span: Define the time span. The X-axis will be equal to the value set for Time Span divided by the value set for Bin Width.

Bin Width: Define the Bin Width. The X-axis will be equal to the value set for Time Span divided by the value set for Bin Width.

Multi View Enabled: Enables multi view for viewing multiple channels. When multi view is enabled, Source Channel should be set to 0.

Num Views: Select the number of channels or sort codes to view. By default, channels will be displayed beginning with channel 1.

Num Columns: Select the number of columns to display.

Category Coloring: Selects the trace coloring method. Traces can be seen in a single color (None), one color per channel (By Channel), or one color per sort code (By SortCode).

Pile Common Parameters

Source Name: Select the data event (Store name) from the currently selected tank.

Source Channel: Selects the channel for viewing. To view a single channel of data enter the desired channel number. To view multiple channels set to 0 and enable multi view.

Pile Depth: Set the minimum number of traces that will be displayed. The maximum number of traces will be twice the value set. The plot will refresh when the maximum number is reached.

Multi View Enabled: Enables multi view for viewing multiple channels. When multi view is enabled, Source Channel should be set to 0.

Num Views: Select the number of channels or sort codes to view. By default, channels will be displayed beginning with channel 1.

Num Columns: Select the number of columns to display.

Category Coloring: Selects the trace coloring method. Traces can be seen in a single color (None), one color per channel (By Channel), or one color per sort code (By SortCode).

Raster Common Parameters

Source Name: Select the data event (Store name) from the currently selected tank.

Source Channel: Selects the channel for viewing. To view a single channel of data enter the desired channel number. To view multiple channels set to 0 and enable multi view.

Raster Rows: Select the number of rows to display.

TimeRef Epc Name: Defines the epoch, or indexed event, that will be used for the raster rows. Click the value box to view a list of events. Valid choices are preceded by an  strobe/indexed event icon.

Time Span: Define the maximum value of the X-axis using a time stamp value.

Multi View Enabled: Enables multi view for viewing multiple channels. When multi view is enabled, Source Channel should be set to 0.

Num Views: Select the number of channels or sort codes to view. By default, channels will be displayed beginning with channel 1.

Num Columns: Select the number of columns to display.

Category Coloring: Selects the trace coloring method. Traces can be seen in a single color (None), one color per channel (By Channel), or one color per sort code (By SortCode).

Scroll Common Parameters

Source Name: Select the data event (Store name) from the currently selected tank.

Source Channel: Selects the channel for viewing. To view a single channel of data enter the desired channel number. To view multiple channels set to 0 and enable multi view.

Scroll Sections: Selects the number of scroll sections to display.

Multi View Enabled: Enables multi-view for viewing multiple channels. When Multi View is enabled, Source Channel should be set to 0.

Num Views: Select the number of channels or sort codes to view. By default channels will be displayed beginning with channel 1.

Num Columns: Select the number of columns to display. Leave this value set to 1 to see one channel per row.

Confine Plotting Data In Cell Boundary: When the checkbox is selected, plot data will not cross its cell boundaries. When disabled, plot data can exceed the boundary.

Plotting Margin Percentage: Select a value to increase or decrease the margin percentage for displaying data while multi view is enabled.

XY Common Parameters

Source Name Y-Axis: Define the Event ID (Store name) for the Y-Axis of the plot. Click  to display a list of available event IDs.

Source Channel: Set to 0 to display all channels. Set to a valid channel number to display a single channel of data.

Source Name X-Axis: Define the Event ID for the X-Axis of the plot. Click  to display a list of available event IDs.

Cloud Points: Set the minimum number of cloud points to display. The maximum number of cloud points will be twice the value set. The plot will refresh when the maximum number is reached.

Multi View Enabled: Enables multi view for viewing multiple channels. When multi view is enabled, Source Channel should be set to 0.

Num Views: Select the number of channels or sort codes to view. By default, channels will be displayed beginning with channel 1.

Num Columns: Select the number of columns to display.

Category Coloring: Selects the trace coloring method. Traces can be seen in a single color (None), one color per channel (By Channel), or one color per sort code (By SortCode).

Data Source Parameter Group

Shared Data Source Parameters

Source Name: Define the Event ID (Store Name) for the plot. Click  to display a list of available event IDs.

Source Channel: Set to 0 to display all channels. Set to a valid channel number to display a single channel of data.

Sorting Code: Set to 0 if a sort parameter has not been defined or will not be used. Set to a valid sort number to display a single sort.

Enabled: Clear the check box to disable the data definition for the plot.

XY Plot Data Source Parameters

Source Name Y-Axis: Define the Event ID (Store name) for the Y-Axis of the plot. Click  to display a list of available event IDs.

Source Channel: Set to 0 to display all channels. Set to a valid channel number to display a single channel of data.

Sorting Code: Set to 0 if a sort parameter has not been defined or will not be used. Set to a valid sort number to display a single sort.

Source Name X-Axis: Define the Event ID (Store name) for the X-Axis of the plot. Click  to display a list of available event IDs.

Enabled: Clear the check box to disable the data definition for the plot.

OpenBrowser Reference

In the OpenBrowser Reference you will find:

A reference guide to the OpenBrowser Workspace and the basics of viewing and exporting data.

About OpenBrowser

OpenBrowser is a data export application for data stored in the OpenEx data tank format. This flexible application is a client of the TTank server. When using OpenBrowser, data from one or more data tanks can be selected, previewed, and exported to a standard ASCII file format or formats compatible with *NeuroExplorer™* or *Plexon's Offline Sorter*. When working in OpenBrowser there are three steps in the data export process: data selection, data browsing, and finally, data export.

Data Selection

Before data can be exported or viewed it must be selected. The desired tank, block, event, and associated values are selected using a spreadsheet like interface and pop-up lists.

Data Browsing

Data can be previewed in a table or as a scroll plot. A time control window allows users to quickly navigate data in the scroll plot view. Data can be viewed along with epoch data allowing the researcher to modify data selections and create subsets of data on the fly.

Data Export

OpenBrowser provides for flexible data export. Several file formats are supported and users can choose to export all data to a single file or to export subsets of data to separate files.

Workspace Basics

About the Open Browser Workspace

OpenBrowser includes a data viewing area and two collapsible sub-windows. A menu bar and toolbar are provided for easy access to commands.

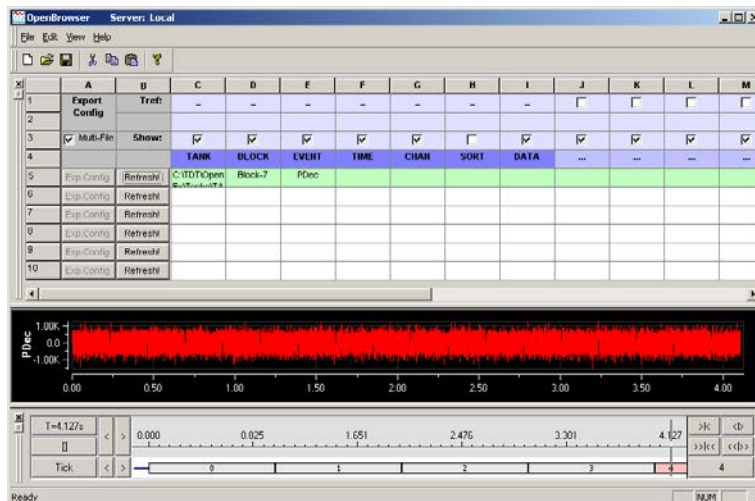

Data Selection Table Window

Data View Area

Time Line Window

Data Selection Table Window

The Data Selection Table window allows users to select events from a data tank. Data is selected and arranged in rows based on the tank, block, event, and other associated variables. The Data Selection Table window also allows users to design a custom configuration file that contains all the export variables and information for a data row.

Data View Area

The data view area displays data selected in the Data Selection Table window. Data can be displayed in either a scroll plot or table view. The scroll plot view displays the waveform data and event times for time reference epochs and can be expanded and contracted using the Time Line window. The table view displays data in a row and column format. In this view, data and time stamp information can be copied and pasted into other applications such as Microsoft Excel. A shortcut menu with Cut, Copy, and Paste commands is also available in this view.

Time Line Window

The Time Line window displays the block's timeline and allows users to move through the selected data using the timeline.

Menus

OpenBrowser File Menu

Some Items on the OpenBrowser File menu are not available when running in OpenProject.

Note: To save changes to a file that is part of an OpenEx project, save the project.

Tank Server	Opens the Select Server window.
New	Opens a new OpenBrowser file.
Open	Opens the Open dialog box so that an existing OpenBrowser file can be opened.
Save	Saves the current OpenBrowser file with the current name. If the file has not previously been saved, the Save As dialog box opens so that the file can be named.
Save As	Opens the Save As dialog box so that the OpenBrowser file can be saved with a new name.
Export Current Row	Exports the currently selected row.
Export Selected Rows	Exports multiple selected rows. Several adjacent rows can be selected by holding down the SHIFT key and clicking the row numbers. Non-adjacent rows can be selected by holding down the CTRL key and clicking the row numbers.

Export All Rows	Exports all rows containing data.
Recently Used Files	The fourth section of the File menu lists recently used files. Clicking a file name opens the file.
Exit	Closes the OpenBrowser application.

OpenBrowser Edit Menu

Undo	Reverses the last action taken in the Data Selection Table window.
Cut	Cuts the selected row(s) in the Data Selection Table or cuts selected data from the Data Table view.
Copy	Copies the selected row(s) in the Data Selection Table or copies selected data in the Data Table view.
Paste	Pastes the most recently cut or copied row(s) in the Data Selection Table or pastes data in the Data Table view.
Delete Rows	Deletes the selected row(s) in the Data Selection Table. If no row is selected the last row is deleted.
Insert Rows	Inserts a row above the currently selected row in the Data Selection Table. If no row is selected the row is added to the bottom of the table.

OpenBrowser View Menu

Toolbar	Toggles the toolbar between displayed and hidden.
Status Bar	Toggles the status bar between displayed and hidden.
Data View Table	Toggles the Data View window between Table view and Scroll Plot view.
Data Selection Table	Toggles the Data Selection Table window between displayed and hidden.
Time Line	Toggles the Time Line window between displayed and hidden.

OpenBrowser Help Menu

About OpenBrowser	Displays version and copyright information for OpenBrowser.
--------------------------	---

Data Selection

About the Data Selection Table Window

The Data Selection Table arranges information in rows and columns. The first three rows define the configuration properties for exporting the data and are separated from the data selection rows by a header row. The data selection rows determine what data is available for export and display. Each row can export data from a single tank, block, and event. To export data from multiple tanks, blocks, or events; a new row of data must be added.

	A	B	C	D	E	F	G	H	I	J
1	Export Config	Tref:	-	-	-	-	-	-		[checked]
2										
3	[checked] Multi-File	Show:	[checked]	[checked]	[checked]	[checked]	[checked]	[unchecked]	[checked]	[checked]
4			TANK	BLOCK	EVENT	TIME	CHAN	SORT	DATA	Freq
5	Exp.Config	Refresh!	C:\TDT\Open	Block-1	Snip					1000

Tref: Check Boxes (Row 1)

This row allows users to select an epoch to be used as a time reference. When the check box in this row is selected for an epoch, the time stamp of the event is based on its position relative to the last epoch as opposed to the start of the block. This is particularly useful if the data is to be exported to *NeuroExplorer™* or *Plexon's Offline Sorter*.

Show: Check Boxes (Row 3)

Selecting a check box in this row includes the associated column information, such as the TANK, BLOCK, CHAN, SORT name and the associated TIME (time stamp), when the data is exported or viewed in the Table view.

Multi-File: Check Box (Cell A3)

If the Multi-File check box is selected when data is exported then the data in each row will be saved to a separate file.

Header Cells (Row 4)

This row displays the header names associated with a data tank. The first seven header names (columns C - I) are standard for all tanks and cannot be changed. The cells under each column header are used to access the associated variable type. Cells in columns J and greater can be used to select epoch header names.

Column Header	Function
TANK	Select the tank for data access.
BLOCK	Select the block number.
EVENT	Select the associated Store.

TIME	Select time stamp values.
CHAN	Enter a channel number or range of channels. Leaving this column blank includes all channels.
SORT	Enter a sort code, or range of sort codes, associated with a snippet event.
DATA	Not implemented at this time.
...	Allows the user to select epoch variables to use as time stamp reference markers. A row must be selected before an epoch can be selected. Right-click an empty header cell to add an epoch.

Data Selection Cells (Rows 5 and Greater)

Users can fill multiple rows with data export information. For example, an experiment might consist of a single block of data with multiple events. An OpenBrowser export file would consist of a series of export rows each with different events and possible channels within an event. This allows a user to configure an OpenBrowser file to organize how the data is exported.

Exp. Config Buttons (Column A)

Clicking the Exp. Config button for a row displays a dialog box that allows users to select how the data in that row is exported.

Refresh! Buttons (Column B)

Clicking the Refresh! button for a row refreshes the View area with data for the selected row.

Using the Data Selection Table Window

The Data Selection Table can be used to select data and to prepare data for export.

Selecting Data

To use the Data Selection Table window; select the tank, block number, then event information for the data to be viewed or exported. These three pieces of information must be selected in order, that is, the tank must be selected before the block can be selected and the block must be selected before the event can be selected. Each piece of information can be added by right-clicking the cell under the appropriate column heading and then double-clicking the desired tank, block, or event from the list in the selection window.

When selecting a tank, right-click in the cell under the Tank heading to bring up the Select Tank dialog. By default, only registered tanks created with OpenEx 2.0 or greater will be shown in the list. To select a tank in the list, single-click the tank name. To select an unregistered new format tank, click the Open Existing Tank icon to open the Browse for Folder dialog and navigate to the desired tank folder.

Note: Clicking OK out of this dialog selects the tank and also closes the Select Tank dialog.

To display registered Legacy tanks, right-click in the Select Tank dialog window and select Show Legacy Tanks. To select a tank in the list, single-click the tank name. To select an unregistered

Legacy tank, right-click in the Select Tank dialog window and click Find Legacy Tank to navigate to the desired tank.

Epochs can be added to the table in the empty header cells (indicated by ellipses) and a single epoch can be used as a time reference by selecting the Tref check box for the epoch column. See Using Epochs as a Time Reference.

Once the first data selection row has been configured in the Data Selection Table, additional rows with the same configuration can be added by copying and pasting the row to a blank row.

After the row has been copied, change the block or event name as needed. To change a cell value, first delete the cell's current value, then right-click the cell to open a list of possible blocks or events. Shorthand characters can also be used to simplify setting up multiple rows. See Using Shorthand Characters for Data Selection, page 276 for more information.

Tip

When using copy and paste to add multiple rows of data, configure the first row for export first. When it is copied and pasted the export configuration will also be included. Be sure to check one or more of the **Append File Name By** check boxes to ensure that multiple rows saved to multiple files will have unique names. See the Data Export book for more information on configuring data for export.

Adding Rows

To add a row click the **Edit** menu, and click **Insert Rows**.

Deleting Rows

To delete selected rows, click the **Edit** menu and click **Delete Rows**. To select a row click the row number. Use the SHIFT or CTRL keys to select multiple rows.

Controlling the Data View Area

After a tank, block number, and event have been associated with the row the user can click on Refresh! to view the data in the View area.

Configuring Data for Export

The Exp. Config buttons for each row provide easy access to the Data Format Export Configuration dialog box. After a row has been configured for export, the text on the Exp.Config button changes from gray to blue. When exporting more than one row, use the Multi-File check box to determine if each row of data will be exported to a separate file or if all data will be exported to one single file.

Using Shorthand Characters for Data Selection

A series of shorthand characters can be used to speed up data selection in the Data Selection Table.

- ^ Indicates that the value in the cell above will be used for this cell. For example, placing a caret in a cell in the TANK column will cause the row to acquire data from the tank named in the row above.
- ^+ Used with BLOCK, CHAN, and SORT cells. It will increment the BLOCK,

CHAN, or SORT number by one, relative to the cell above it.

> Used with TIME CHAN, SORT, and epoch cells. Channels that are greater than the cell value are viewed and exported. For example, >3 selects channel or sort values greater than 3.

< Used with TIME, CHAN, SORT, and epoch cells. Values that are less than the cell value are viewed and exported.

: Used with TIME, CHAN, SORT, and epoch cells. Values in the named range are viewed and exported. For example, if a cell in the CHAN column contained the statement 3:10 then channels 3 through 10 would be viewed and exported.

In the example below, data would be exported from tank **nefw**, blocks **45** and **46**, and all **SPKE** and **SSPK** events (including all channels). Note how that ^+ is only used once for the BLOCK cell for SPKE in row 7. If the BLOCK cell for the SSPK event in row 8 used a ^+, the data would have come from block 47.

	A	B	C	D	E	F	G
1	Export Config	Tref:	-	-	-	-	-
2							
3	<input checked="" type="checkbox"/> Multi-File	Show:	<input type="checkbox"/>	<input checked="" type="checkbox"/>	<input checked="" type="checkbox"/>	<input checked="" type="checkbox"/>	<input checked="" type="checkbox"/>
4			TANK	BLOCK	EVENT	TIME	CHAN
5	Exp.Config	Refresh!	nefw	Block-45	SPKE		
6	Exp.Config	Refresh!	^	^	SSPK		
7	Exp.Config	Refresh!	^	^+	SPKE		
8	Exp.Config	Refresh!	^	^	SSPK		

Using Epochs as a Time Reference

The Data Selection Table allows users to select an epoch to be used as a time reference. Using a time reference epoch starts the time value at zero for each epoch and allows the time code information to be used to generate PSTH and other graphs in *NeuroExplorer* and other analysis applications.

	A	B	C	D	E	F	G	H	I	J
1	Export Config	Tref:	-	-	-	-	-	-		<input checked="" type="checkbox"/>
2										
3	<input checked="" type="checkbox"/> Multi-File	Show:	<input type="checkbox"/>	<input checked="" type="checkbox"/>	<input checked="" type="checkbox"/>	<input checked="" type="checkbox"/>	<input checked="" type="checkbox"/>	<input type="checkbox"/>	<input checked="" type="checkbox"/>	<input checked="" type="checkbox"/>
4			TANK	BLOCK	EVENT	TIME	CHAN	SORT	DATA	Freq
5	Exp.Config	Refresh!	C:\TDT\Open	Block-1	Snip					1000: 2000
6	Exp.Config	Refresh!	^	^+	^					^
7	Exp.Config	Refresh!	^	^+	^					^
8	Exp.Config	Refresh!								

To add a time reference:

1. Select the Tref check box (in Row 1) for an empty epoch column. The header for an empty epoch column contains an ellipse.
2. Select a row containing data selection information for the tank, block, and event. To select a row click the row number.
3. In the Header row, right-click the cell (containing an ellipse "...") for that column. This will open an event selection dialog box. The available epoch events are listed (that is, available in the tank named in the TANK column for the currently selected row).
4. To select the epoch to be used as a time reference, double-click the epoch in the list. Additional epochs can be added to subsequent columns; however, only one time reference epoch can be active at a time.

Note: A specific value or range of values can be selected using the epoch cell for a row. For example, entering ">1000" in an epoch cell will limit the epoch values used to those greater than 1000. A single value may be selected by entering a number without a modifier, such as "1000". See the Using Shorthand Characters, page 276 for more information.

The active time reference determines the zero time for the time stamps. When the Show check box is selected for an epoch column the epoch will be included in the view area for any row that is refreshed. It will be displayed above the data in the scope plot view or show as a separate column in the data table view.

Data Browsing

About the Data View Area

The Data View area allows table or graphic visualization of tank data from a selected row. To switch between table and scroll plot views, select or clear the Data View Table option on the View menu.

Scroll Plot View

The scroll plot displays waveform or scalar data from an event as well as the associated scalar information from epochs. Epochs are displayed above the event data. In the scroll plot below, an epoch (Freq) associated with the time line is shown above the event (Snip) line.

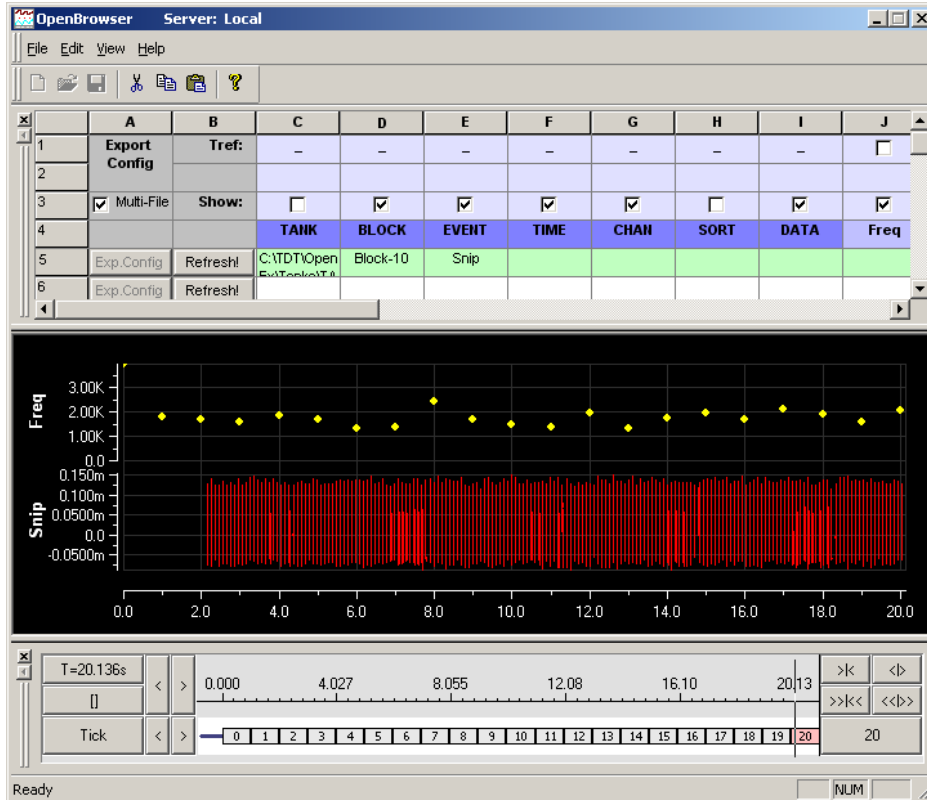

To modify which epochs are displayed, choose the Show check box for the event column in the Data Selection Table window.

To move about the Scroll plot, select the marker in the Time Line window and move it to the time stamp or event of interest. The time range can be expanded or contracted to give additional detail about the waveforms using the Time Line window.

Table View

In table view the variables selected in the Show row of the Data Selection Table window are displayed. The time stamp associated with the event and any associated epochs are displayed. If Tref is selected in the Data Selection Table window the time stamps displayed will be relative to the start of the epoch.

To determine which variables such as block number, tank name, time stamp, and epochs are displayed, choose the corresponding Show check boxes in the Data Selection Table window.

All data can be copied and pasted from the table to a Microsoft Word document or Excel spreadsheet. To copy the data, select the range of cells, right-click the selected cells, and click the Copy command on the shortcut menu. To paste the data into another application, go to that application and press CTRL+V.

In the example below the event, time stamp (in this case the spike times), channel number, and epochs are displayed.

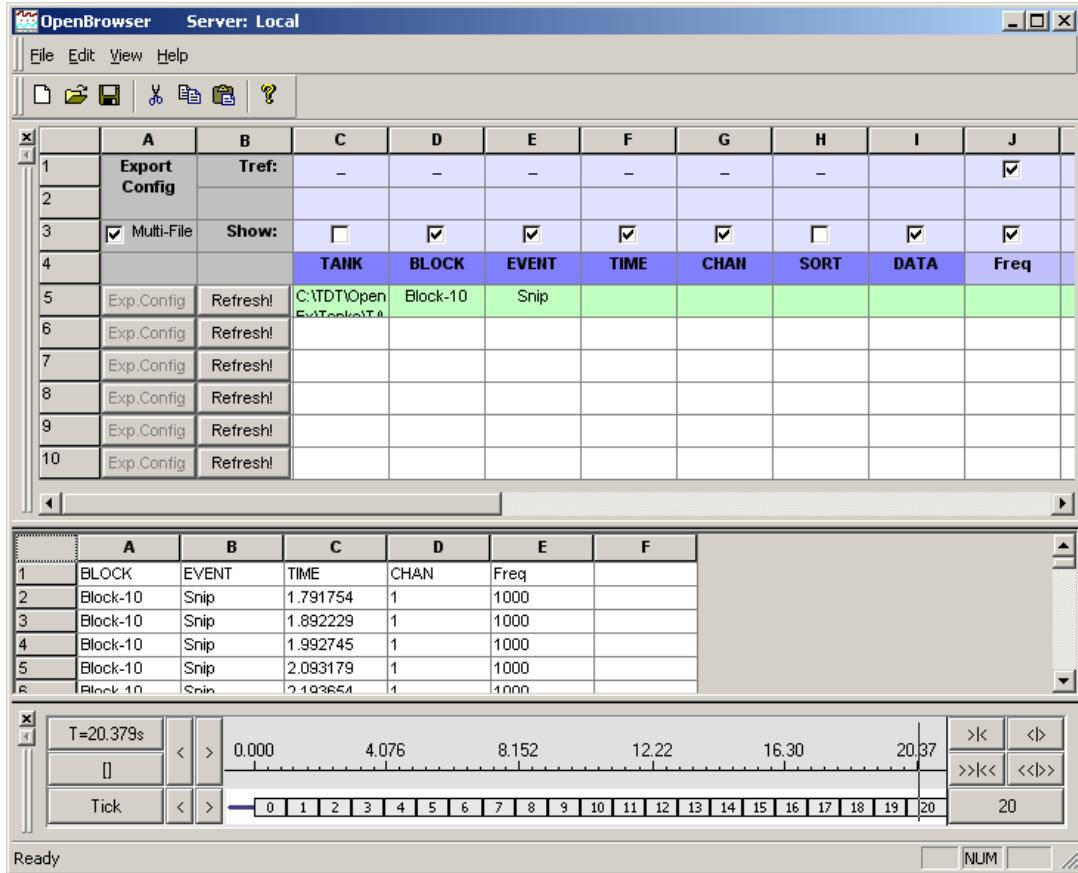

Using the Time Line Window

The Time Line window provides a timeline and vertical line indicator that moves as data is animated in the Scroll Plot view of the Data View area. The Time Line window can also be used to move to a particular time or event in the Data View area. Epoch events that are included in the selected data area are also added to the window. The Time Line window gives a precise description of when data was collected.

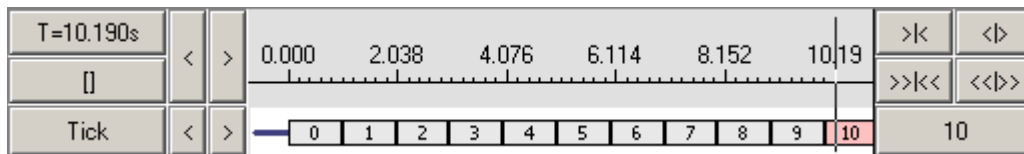

Timeline by Time Stamps

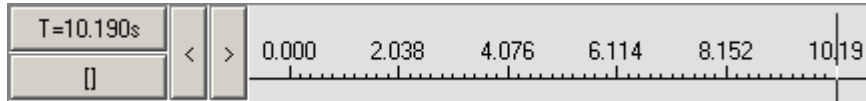

T=10.190s

The current time stamp.



Moves the indicator back by time stamps.



Moves the indicator forward by time stamps.

Scale Controls



Expands scale in small steps.



Shrinks scale in small steps.



Expands scale in large steps.



Shrinks scale in large steps.

Timeline by Events



Tick

The name of the event displayed on the corresponding line.



Moves the indicator back by events.



Moves the indicator forward by events.

10

The current event value.

Data Export

Exporting Tank Data

The primary function of OpenBrowser is to export data from the tank to other data formats. OpenBrowser can export to several common file formats: ASCII, NEX, PLX, DDT and EDF. The standard ASCII format allows users to export data in a format readable by most statistical and graphic packages as well as Microsoft Excel spreadsheets. OpenBrowser can also export directly to the NEX format for import to *NeuroExplorer*[™], the PLX and DDT (v101) formats for use with *Plexon's Offline Sorter*, or EDF (European Data Format).

Note: The NEV export function is no longer supported.

Export From the File Menu

The File menu provides the following three choices for exporting data:

- **Export Current Row:** Exports the currently selected row.
- **Export Selected Rows:** Exports multiple selected rows.
- **Export All Rows:** Exports all rows containing data.

Before data can be exported using these commands it must be selected and configured for export. Data is selected using the Data Selection Table window. When multiple rows of data have been selected the user can choose to export multiple rows to a single file or to export each row to a separate file. Single or Multi-File export is determined using the Multi-File check box in the Data Selection Table window. If exporting to multiple files, each row must be configured before the export process begins. Individual rows of data can be configured for export at any time using the Exp. Config buttons. If exporting to a single file, the export configuration can be defined during the export process. If the export configuration has not been completed prior to export, the Data Export Format Configuration dialog box will be displayed during the export process.

Exporting From the Data Table View

The data in the data table can be copied and pasted directly to a Microsoft Excel spreadsheet. This will save all the information about blocks, events, time stamps, channel, sort, and Epoch information displayed in the table view. It does not export the waveform data.

Using the Data Export Format Configuration Dialog Box

The Data Export Format Configuration dialog box is used to configure data for export before or during the export process.

To open the Data Export Format Configuration dialog box, click the Exp. Config button for a row. The settings available depend on the export format selected in the File Type box in the upper left corner of the dialog box.

After the export settings are configured, clicking the Save button stores the export information for future use and the color of the Exp. Config button text changes to blue.

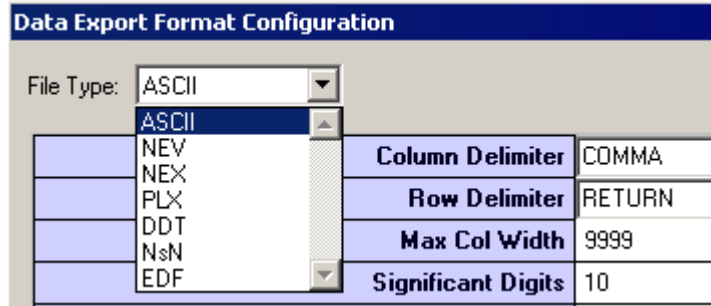

File Type Drop Down Menu

ASCII Export Settings

Column Delimiter: data is exported with the specified separators between columns.

COMMA: each value is separated by a comma. This is the default Excel importing format.

TAB: each value is separated by a tab.

RETURN: each value is separated by a return character.

Row Delimiter: data is exported with the specified separators between rows.

RETURN: each row is separated by a return character (most common).

TAB: each row is separated by a tab.

COMMA: each row is separated by a comma.

Max Col Width: maximum number of columns in a row. When the maximum number is reached, a row delimiter is generated. To ensure the integrity of exported data when viewed in the target application, set the Max Col Width for that application before export.

In applications, like Excel, that have a maximum number of columns, exceeding the application's maximum number of columns might cause problems when the exported data is opened in the target application. Problems might include truncated data display, automatically generated and undesirable row delimiters, and so forth. For example, if the user attempts to open an export file with more than 248 data samples in Microsoft Excel (which is limited to 256 cells in a row), the excess samples will be discarded and Excel will generate a "File not loaded completely" message. Note that the reason the maximum number is 248 is that at least six columns out of the 256 are used for other information such as block, event, time stamps, and so forth. If more than six columns are used before the data columns, then there will be fewer columns available for data. *See also Number of data subsections, page 284 for more information.*

Significant Digits: number of digits saved for each value starting with the first non-zero digit. This parameter is applied to time stamps as well as data.

Hide Title: hides the first row with the column descriptions.

Raw Data Only: saves only the signal data and discards all of the other details like tank name, block name, event, time, sampling frequency, and number of points.

Output File Name: allows the user to browse to and set the location and name for the output file(s).

Append File Name By ...: appends the block, event, channel number, and/or row number of the exported data to the output file name. This is very useful when the Multi-File option is selected.

Number of data subsections: used to divide the data samples into subsections. By default, each data set is stored in a single row with the tank name, block name, and so forth at the beginning of the row. Specifying subsections allows the data to be stored using several rows. Each row (or subsection) includes the header information such as tank name, block name, followed by a subset of data samples.

This option is useful when loading a data file with a large number of samples. For example, if the user intends to work with exported data in Excel then each row must be limited to no more than 256 cells. A file with 300 points in each record can be exported specifying 2 subsections to create two rows dedicated to each record, each with 150 sample points. This would ensure that the maximum number of cells per row is not exceeded and creates a file with a consistent set of row headers at the beginning of each row. *See also Max Col Width, page 283 for more information.*

Transpose output (data in columns): transposes columns to rows so that each column is a data set (by default, OpenEx data is saved in rows). This option can be used when exporting a data file containing a large number of samples for use with Microsoft Excel. By saving data in columns the user avoids limitations in the maximum number of cells possible in a row.

PLX Export Specific Settings

Export epoch events as plx strobe events: used to display epoch events as strobe events in *NeuroExplorer™*. Not used when exporting for use with *Plexon's Offline Sorter*.

Gain (for spike waveform, in K): used with Scaling Factor to scale spike data for viewing in Offline Sorter. Recommended value is 1. Values can be from 1 to 32.

Spike Scaling Factor (Floating Point to μV): used with Gain to scale spike data for viewing in Offline Sorter.

Gain (for continuous waveform): used with Scaling Factor to scale continuous data for viewing in Offline Sorter. Recommended value is 1. Values can be from 1 to 32.

Stream Scaling Factor (Floating Point to μV): used with Gain to scale continuous data for viewing in Offline Sorter.

Comment: 256 character comment line.

Output File Name: allows the user to browse to a network or local folder and saves the file with a set name.

Note: See Exporting to PLX, page 289 for detailed information on using *PLX Export Specific Settings*.

Append File Name By ...: allows the user to select to automatically add the block, event, channel number, and/or row number of the exported data to the saved file name. This is very useful when the Multi-File option is selected.

DDT Export Settings

Output File Name: allows the user to browse to and set the location and name for the output file(s).

Description: optional text field that is included in DDT header.

Scale Factor: used to scale streaming data before converting to integer values for viewing in Offline Sorter.

Append File Name By ...: appends the block, event, channel number, and/or row number of the exported data to the output file name. This is very useful when the Multi-File option is selected.

NEX Export Specific Settings

Quant Factor (mV per LSB): Sets the millivolt range for the Least Significant Bit of the NEX format. The default value has been set to insure that the data is exported correctly. Changing the default settings can cause data to be read incorrectly by *NeuroExplorer*TM.

Scaling Factor (to convert Tank Data to μ V): Not used.

Comment: 256 character comment line.

Append Event Name by Channel #: allows the user to select to automatically add the channel number to the event name.

Output File Name: allows the user to browse to a network or local folder and saves the file with a set name.

Append File Name By ...: allows the user to select to automatically add the block, event, channel number, and/or row number of the exported data to the saved file name. This is very useful when the Multi-File option is selected.

Note: The NEV export function is no longer supported.

NsN Export Specific Settings

For more information regarding the NeuroShare Native (NsN) file format, refer to the NeuroShare website at: <http://neuroshare.sourceforge.net/index.shtml>

Output File Name: specifies the path and filename for the exported *.nsn file.

File Type Descriptor: specifies the file extension for the exported data file. This should be set to .nsn.

Time Stamp Resolution: minimum timestamp resolution in seconds.

Digitization Scaling Factor (in nV): not used

Scaling Factor (to Convert Tank Data to μV): scale factor used for buffer (type 2), snippet (type 4), or continuous (type 5) data. Recommended value is 1.

Scaling Factor (to Convert Event Tank Data): scale factor used for scalar (type 1) or list (type 3) data. Recommended value is 1.

File Comment: 256 character comment line.

Min Input Signal: minimum possible value of the input signal in Volts.

Max Input Signal: maximum possible value of the input signal in Volts.

Units: Enter a text value to specify the recording units of measurement.

Input Signal Resolution: minimum input step size that can be resolved. To obtain the signal resolution divide the voltage range by the number of bit values. E.g. for a +/- 1 Volt 16-bit ADC this value is $2 / 2^{16}$ or 0.0000305.

X Location: optional text information about the X coordinate of source in meters.

Y Location: optional text information about the Y coordinate of source in meters.

Z Location: optional text information about the Z coordinate of source in meters.

High Freq Cutoff: high frequency cutoff in Hz of the source signal filtering.

High Freq Order: order of the filter used for high frequency cutoff.

High Freq Filter Type: optional text information to describe the type of filter used for high frequency cutoff.

Low Freq Cutoff: low frequency cutoff in Hz of the source signal filtering.

Low Freq Order: order of the filter used for low frequency cutoff.

Low Freq Filter Type: optional text information that describes the type of filter used for low frequency cutoff.

Probe Info: optional text information about the signal source.

EDF Export Settings

Output File Name: specifies the path and filename for the exported *.edf file.

Description: optional text used to describe the data. This is included in the EDF header.

Scale Factor: used to scale streaming data before converting to integer values for EDF format.

Units: enter a text value to specify the recording units of measurement after scaling.

Generate Test Data: optional checkbox. When selected, the output will contain eight channels of recognizable test data signals (sine wave, sawtooth, pulse, noise, etc) that can be viewed in an EDF viewer to validate the export.

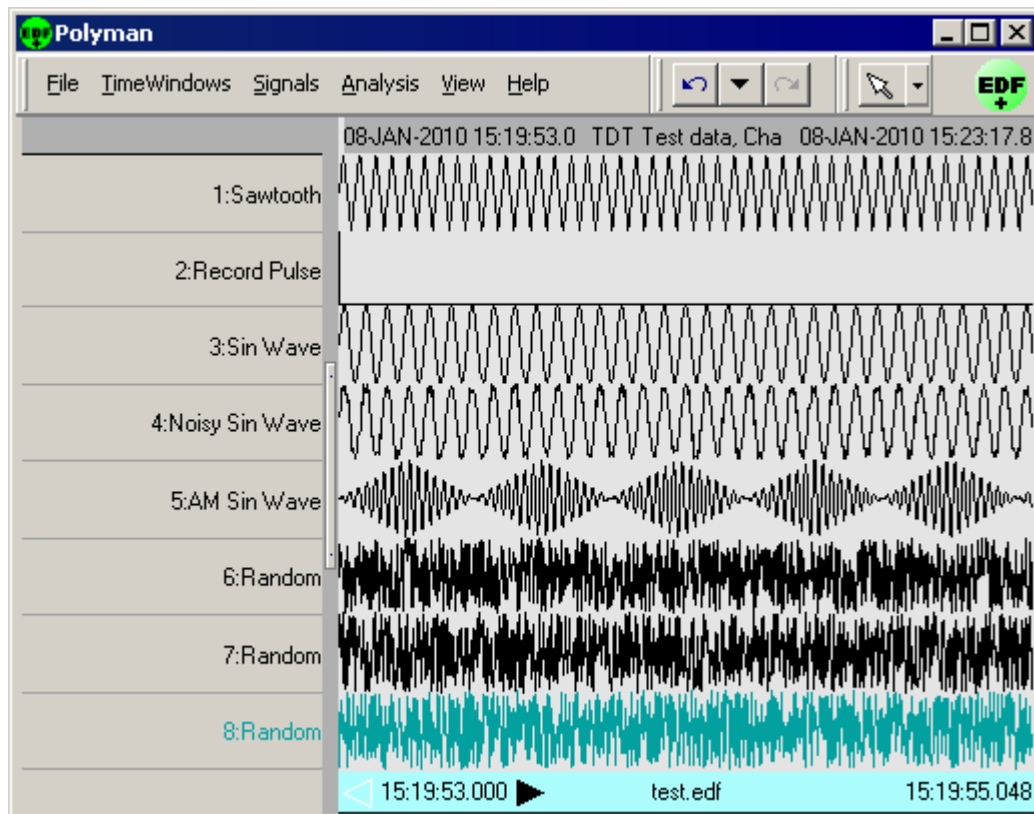

Exported Test Data Viewed in Polyman

An example of the generated test data can be found in the image above. The Polyman EDF viewer software was used to load the data and capture this image.

Append File Name By ...: appends the block, event, channel number, and/or row number of the exported data to the output file name. This is very useful when the Multi-File option is selected.

Exporting to ASCII

Exporting to the standard ASCII format allows users to access data in a format readable by most statistical and graphic packages as well as Microsoft Excel spreadsheets. When data is exported in the ASCII format, the first six columns always denote the block name, event, time stamp, channel, sampling frequency, and number of points in each record. Subsequent columns contain actual data. Additional columns may be added before data columns to store information such as subsections, epoch events. The first row contains header information (describing the data stored in each column, such as BLOCK, EVENT, TIME, and so forth) for each column.

Export to Multiple Files

1. When exporting to multiple files, ensure that the **Multi-File** check box in cell A3 of the Data Selection Table window is checked.
2. Configure each row for export. To configure a row for export:
 - a. Click the **Exp. Config** button for the desired row.
 - b. In the Data Export Format Configuration dialog box, ensure that **ASCII** is selected in the File Type box.
 - c. Name the export file. Click the  **Browse** button to the right of the **Output File Name** box. The Open dialog box is displayed.
 - d. Browse to the desired file location. When using OpenBrowser within OpenProject the default location will be the UserFiles folder for the current project.
 - e. Type a file name in the **File Name** box and click **Open**. You can type individual names for each row/file or use the same base file name for all rows/files. If you use a base name be sure to use the Append File Name by check boxes. If two or more rows attempt to write to exactly the same file, data will be overwritten.
 - f. If desired, select one or more of the **Append File Name By** check boxes to include block, channel, event, or row information in the file name.
 - g. Modify any other settings as desired.
 - h. Click **Save**.
3. Repeat for each row to be exported. To save time, complete the export configuration during the data selection process. That way if you use copy and paste to add rows the export configuration will also be copied. Be sure to use one or more of the **Append File Name By** check boxes to ensure that each row will have a unique file name.
4. If exporting only selected rows, select the rows to export and click **Export Selected Rows** on the File menu.
5. If exporting all rows, click **Export All Rows** on the File menu.
6. Review the messages in the Export Status dialog box and click **OK**.

Export to a Single File.

1. When exporting to a single file, ensure that the **Multi-File** check box in cell A3 of the Data Selection Table window is not checked.

2. If exporting a single row, select the row and click **Export Current Row** on the File menu.
3. If exporting only selected rows, select the rows to export and click **Export Selected Rows** on the File menu.
4. If exporting all rows, click **Export All Rows** on the File menu.
5. In the Data Export Format Configuration dialog box, ensure that **ASCII** is selected in the File Type box.
6. Click the **...** **Browse** button to the right of the **Output File Name** box. The Open dialog box is displayed.
7. Browse to the desired location for the data file. When using OpenBrowser within OpenProject the default location will be the UserFiles folder for the current project.
8. Type a file name in the **File Name** box and click **Open**.
9. Modify any other settings as desired.
10. Click **Export**.
11. Review the messages in the Export Status dialog box and click **OK**.

	A	B	C	D	E	F
1	BLOCK	EVENT	TIME	CHAN	Sampling	Freq
2	Block-10	Snip	1.791754	1	24414.06	1000
3	Block-10	Snip	1.892229	1	24414.06	1000
4	Block-10	Snip	1.992745	1	24414.06	1000
5	Block-10	Snip	2.093179	1	24414.06	1000
6	Block-10	Snip	2.193654	1	24414.06	1000
7	Block-10	Snip	2.294129	1	24414.06	1000

Exported Data Viewed in Microsoft Excel

Exporting to PLX

OpenBrowser can export directly to the PLX format for use with *Plexon's Offline Sorter* and *Wave Tracker*. Data exported in PLX format can also be viewed with *NeuroExplorer™*. For researchers who use several different analysis packages, exporting to the PLX format eliminates the need to export data in several different formats. The PLX export has been streamlined to provide the user with both flexibility and ease of use.

Note: Use *Offline Sorter* version 2.5 or greater, if possible. Earlier versions of *Offline Sorter* might be unable to import OpenEx Stream data. The latest version of *Offline Sorter* is available at http://www.plexoninc.com/Software_downloads.htm.

When tank data is exported to PLX format it must be scaled to match the requirements of the new format. This is done using two parameters; a scaling factor that scales the signal to the correct range and a gain factor that sets the units (mV, μ V). Because *Offline Sorter* and *Wave Tracker* handle streamed data and spike data differently, users must set separate scaling factors and gain settings for each type of data. Once these values have been set, OpenBrowser automatically ensures that streamed data and spike data are exported correctly.

Before beginning the export process users should:

1. Ensure that block size for each waveform is less than 256.

Data that will be exported for use with *Offline Sorter* or *Wave Tracker* should have a block size (in the OpenEx Header) of less than 256 samples.

2. Determine if the PLX data will be used in *NeuroExplorer™*.

The PLX export configuration settings include an **Export epoch events as plx strobe events** check box. If the data will be viewed in *NeuroExplorer™*, this check box must be selected. If *NeuroExplorer™* will not be used, the check box may be left cleared.

3. Determine the highest absolute value in the data set.

The highest value is used to calculate the scaling factor for export. It is an absolute number and can be approximated. An approximate value for the highest number can be determined at a glance when viewing the data set in the OpenBrowser preview plot. Simply refresh the data then view the scale values. Because the plot scales automatically, the maximum scale value is a good approximation of the maximum value in the data set.

4. Select a **Gain** setting.

Gain is expressed as an integer from 1 to 32. The gain is used to display data in *Offline Sorter* or *Wave Tracker* using the correct units, such as μ Vs. When unit information is not important, the gain can be safely set to 1 to simplify the formula for determining the scaling factor.

5. Calculate **Scale Factor** for Stream and/or Snippet data.

The scaling factor can be determined using the following formula, where G = gain, SF = scaling factor, and H# = the highest absolute value in the data set. Note that when processing spike data, setting the gain to 1, and the scale factor to 1×10^6 is usually acceptable.

For streamed data: $SF \times G = 5 \times 10^6 / H\#$

For spike data: $SF \times G = 3 \times 10^3 / H\#$

To better understand how the $SF * G$ formulas are derived, begin by considering these facts:

- Data collected in OpenEx are stored as floating point values while *Offline Sorter* expects data stored as 12-bit signed integers. A 12-bit signed integer yields a maximum value of 2047.
- In *Offline Sorter*, the maximum voltage for streamed data is 5 Volts and the maximum voltage for spike data is 3 Volts.
- OpenEx data is typically viewed in the microvolt range ($1e-6$).
- OpenBrowser uses a user-specified scaling factor (SF) and gain (G) when exporting tank data to a PLX format.

For the highest value (H#) in the tank data, the specified SF and G must yield a value that can be expressed within *Offline Sorter's* dynamic range. This can be expressed as:

$$H\# * SF * 1e-6 * 2048 * G / 5 < 2048$$

Export to Multiple Files

1. When exporting to multiple files, ensure that the **Multi-File** check box in cell A3 of the Data Selection Table window is checked.

2. Configure each row for export. To configure a row for export:
 - a. Click the **Exp. Config** button for the desired row.
 - b. In the Data Export Format Configuration dialog box, ensure that **PLX** is selected in the File Type box.
 - c. Enter the appropriate **gain** and **scaling factor** for the data type being exported in the current row.
 - d. Name the export file. Click the  **Browse** button to the right of the **Output File Name** box. The Open dialog box is displayed.
 - e. Browse to the desired file location. When using OpenBrowser within OpenProject the default location will be the UserFiles folder for the current project.
 - f. Type a file name in the **File Name** box and click **Open**. You can type individual names for each row/file or use the same base file name for all rows/files. If you use a base name be sure to use the Append File Name by check boxes. If two or more rows attempt to write to exactly the same file, data will be overwritten.
 - g. If desired, select one or more of the **Append File Name by** check boxes to include block, channel, event, or row information in the file name.
 - h. Modify any other settings as desired.
 - i. Click **Save**.
3. Repeat for each row to be exported. To save time, complete the export configuration during the data selection process. That way if you use copy and paste to add rows the export configuration will also be copied. Be sure to use one or more of the Append File Name by check boxes to ensure that each row will have a unique file name.
4. If exporting only selected rows, select the rows to export and click **Export Selected Rows** on the File menu.
5. If exporting all rows, click **Export All Rows** on the File menu.
6. Review the messages in the Export Status dialog box and click **OK**.

Export to a Single File

Note: if exporting multiple channels to a single PLX file for use in *Offline Sorter's Tetrode Mode*, use a single row, not different rows for each channel.

1. When exporting to a single file, ensure that the **Multi-File** check box in cell A3 of the Data Selection Table window is not checked.
2. If exporting a single row, select the row and click **Export Current Row** on the File menu.
3. If exporting only selected rows, select the rows to export and click **Export Selected Rows** on the File menu.
4. If exporting all rows, click **Export All Rows** on the File menu.
5. In the Data Export Format Configuration dialog box, ensure that **PLX** is selected in the File Type box.
6. Enter the gain and scaling factor for each type of data to be exported.

If both streamed and snippet data are being exported to the same file, values can be specified for each type of data in a single export configuration dialog box. If only one type of data is being exported, only the gain and scaling factor for that data type will be used and the others will be ignored.

However, keep in mind that all rows of a particular data type will be exported using the same gain and scaling factor. If two rows of the same data type are dissimilar they might need to be exported separately.

7. Click the  **Browse** button to the right of the **Output File Name** box. The Open dialog box is displayed.
8. Browse to the desired location for the data file. When using OpenBrowser within OpenProject the default location will be the UserFiles folder for the current project.
9. Type a file name in the **File Name** box and click **Open**.
10. Modify any other settings as desired.
11. Click **Export**.
12. Review the messages in the Export Status dialog box and click **OK**.

Troubleshooting the Export Process

The following table will help users identify common errors that might occur during the export process.

Symptom	Problem
OpenBrowser crashes during export	This usually indicates that an error was made in calculating the scaling factor
Data seems to small or too large in <i>Offline Sorter/Wave Tracker</i>	An error was made in calculating the scaling factor
Data is displayed with the wrong units in <i>Offline Sorter/Wave Tracker</i>	An error was made in selecting a Gain setting
<i>Offline Sorter/Wave Tracker</i> displays a message that states that the user needs OfflineSorterLong.exe.	This usually indicates that the block size for exported data was greater than 256 samples.
Epoch events are not recognized as strobe events in <i>NeuroExplorer™</i> .	The Export epoch events as plx strobe events check box was not selected during export.
Events are named incorrectly in <i>NeuroExplorer™</i> .	The Export epoch events as plx strobe events check box was not selected during export.

Exporting to DDT

OpenBrowser can export directly to DDT format version 101. A DDT data file is used to import streaming waveforms into Plexon's *Offline Sorter*.

Before data can be exported it must be selected and configured for export using the Data Selection Table window.

Export to Multiple Files

1. When exporting to multiple files, ensure that the **Multi-File** check box in cell A3 of the Data Selection Table window is checked.
2. Configure each row for export. To configure a row for export:
3. Click the **Exp. Config** button for the desired row.
4. In the Data Export Format Configuration dialog box, ensure that **DDT** is selected in the File Type box.
5. Name the export file. Click the  **Browse** button to the right of the **Output File Name** box. The Open dialog box is displayed.
6. Browse to the desired file location. When using OpenBrowser within OpenProject the default location will be the UserFiles folder for the current project.
7. Type a file name in the **File Name** box and click **Open**. You must type individual names for each row/file. If two or more rows attempt to write to exactly the same file, data will be overwritten.
8. Modify any other settings as desired.
9. Click **Save**.
10. Repeat for each row to be exported.
11. If exporting only selected rows, select the rows to export and click **Export Selected Rows** on the File menu.
12. If exporting all rows, click **Export All Rows** on the File menu.
13. Review the messages in the Export Status dialog box and click **OK**.

Export to a Single File.

1. When exporting to a single file, ensure that the **Multi-File** check box in cell A3 of the Data Selection Table window is not checked.
2. If exporting a single row, select the row and click **Export Current Row** on the File menu.
3. If exporting only selected rows, select the rows to export and click **Export Selected Rows** on the File menu.
4. If exporting all rows, click **Export All Rows** on the File menu.
5. In the Data Export Format Configuration dialog box, ensure that **EDF** is selected in the File Type box.
6. Click the  **Browse** button to the right of the **Output File Name** box. The Open dialog box is displayed.
7. Browse to the desired location for the data file. When using OpenBrowser within OpenProject the default location will be the UserFiles folder for the current project.

8. Type a file name in the **File Name** box and click **Open**.
9. Modify any other settings as desired.
10. Click **Export**.
11. Review the messages in the Export Status dialog box and click **OK**.

Troubleshooting the Export Process

The following table will help users identify common errors that might occur during the export process.

Symptom	Problem
Data seems to small or too large in <i>Offline Sorter</i>	An error was made in selecting the scaling factor
Data is displayed with the wrong units in <i>Offline Sorter</i>	An error was made in selecting the scale factor
<i>Offline Sorter</i> crashes or hangs when opening DDT file made by OpenBrowser	The sampling rate of the waveforms exported to DDT must be higher than 1 kHz for some versions of <i>Offline Sorter</i>

Exporting to NEX

OpenBrowser can export directly to the *NeuroExplorer*TM NEX format.

Export to Multiple Files

1. When exporting to multiple files, ensure that the **Multi-File** check box in cell A3 of the Data Selection Table window is checked.
2. Configure each row for export. To configure a row for export:
 - a. Click the **Exp. Config** button for the desired row.
 - b. In the Data Export Format Configuration dialog box, ensure that **NEX** is selected in the File Type box.
 - c. Name the export file. Click the  **Browse** button to the right of the **Output File Name** box. The Open dialog box is displayed.
 - d. Browse to the desired file location. When using OpenBrowser within OpenProject the default location will be the UserFiles folder for the current project.
 - e. Type a file name in the **File Name** box and click **Open**. You can type individual names for each row/file or use the same base file name for all rows/files. If you use a base name be sure to use the Append File Name by check boxes. If two or more rows attempt to write to exactly the same file, data will be overwritten.
 - f. If desired, select one or more of the **Append File Name by** check boxes to include block, channel, event, or row information in the file name.
 - g. Modify any other settings as desired.
 - h. Click **Save**.

3. Repeat for each row to be exported. To save time, complete the export configuration during the data selection process. That way if you use copy and paste to add rows the export configuration will also be copied. Be sure to use one or more of the Append File Name by check boxes to ensure that each row will have a unique file name.
4. If exporting only selected rows, select the rows to export and click **Export Selected Rows** on the File menu.
5. If exporting all rows, click **Export All Rows** on the File menu.
6. Review the messages in the Export Status dialog box and click **OK**.

Export to a Single File

1. When exporting to a single file, ensure that the **Multi-File** check box in cell A3 of the Data Selection Table window is not checked.
2. If exporting a single row, select the row and click **Export Current Row** on the File menu.
3. If exporting only selected rows, select the rows to export and click **Export Selected Rows** on the File menu.
4. If exporting all rows, click **Export All Rows** on the File menu.
5. In the Data Export Format Configuration dialog box, ensure that **NEX** is selected in the File Type box.
6. Click the  **Browse** button to the right of the **Output File Name** box. The Open dialog box is displayed.
7. Browse to the desired location for the data file. When using OpenBrowser within OpenProject the default location will be the UserFiles folder for the current project.
8. Type a file name in the **File Name** box and click **Open**.
9. Modify any other settings as desired.
10. Click **Export**.
11. Review the messages in the Export Status dialog box and click **OK**.

Exporting to EDF

OpenBrowser can export directly to EDF format. An EDF data file consists of a header record followed by binary data records. More details about the EDF standard can be found online here: <http://www.edfplus.info/specs/edf.html>.

Note: OpenBrowser does not support the EDF+ format.

Before data can be exported it must be selected and configured for export using the Data Selection Table window.

Export to Multiple Files

1. When exporting to multiple files, ensure that the **Multi-File** check box in cell A3 of the Data Selection Table window is checked.
2. Configure each row for export. To configure a row for export:
3. Click the **Exp. Config** button for the desired row.

4. In the Data Export Format Configuration dialog box, ensure that **EDF** is selected in the File Type box.
5. Name the export file. Click the  **Browse** button to the right of the **Output File Name** box. The Open dialog box is displayed.
6. Browse to the desired file location. When using OpenBrowser within OpenProject the default location will be the UserFiles folder for the current project.
7. Type a file name in the **File Name** box and click **Open**. You must type individual names for each row/file. If two or more rows attempt to write to exactly the same file, data will be overwritten.
8. Modify any other settings as desired.
9. Click **Save**.
10. Repeat for each row to be exported.
11. If exporting only selected rows, select the rows to export and click **Export Selected Rows** on the File menu.
12. If exporting all rows, click **Export All Rows** on the File menu.
13. Review the messages in the Export Status dialog box and click **OK**.

Export to a Single File.

1. When exporting to a single file, ensure that the **Multi-File** check box in cell A3 of the Data Selection Table window is not checked.
2. If exporting a single row, select the row and click **Export Current Row** on the File menu.
3. If exporting only selected rows, select the rows to export and click **Export Selected Rows** on the File menu.
4. If exporting all rows, click **Export All Rows** on the File menu.
5. In the Data Export Format Configuration dialog box, ensure that **EDF** is selected in the File Type box.
6. Click the  **Browse** button to the right of the **Output File Name** box. The Open dialog box is displayed.
7. Browse to the desired location for the data file. When using OpenBrowser within OpenProject the default location will be the UserFiles folder for the current project.
8. Type a file name in the **File Name** box and click **Open**.
9. Modify any other settings as desired.
10. Click **Export**.
11. Review the messages in the Export Status dialog box and click **OK**.

Single Vs. Multi-File Export

The user can determine if data will be exported to multiple files or a single file using the Multi-File check box in the Data Selection Table window.

Single File Export

If the Multi-File check box is not checked (cell A3) all data is exported to a single file. To use this export function the rows do not have to have been configured before the export process begins. The Data Export Format Configuration dialog box will be displayed during export, giving the user an opportunity to complete configuration. If a single row is selected and has been configured, the dialog box will show the output format for that row. If multiple (or all) rows have been selected the dialog box will display the output format for the first row.

Note: error messages will occur if a row has no data in it.

Multi-File Export

If the Multi-File check box has been selected each row of data will be saved to a separate file. Each row can have a unique file format. Rows must be configured for export using the Data Export Format Configuration dialog box prior to the export process.

When the export process begins the selected rows are immediately stored to files based on the export configuration format specified. If rows are not configured for export a warning message is displayed in the Export Status dialog, starting with the first row that could not be exported.

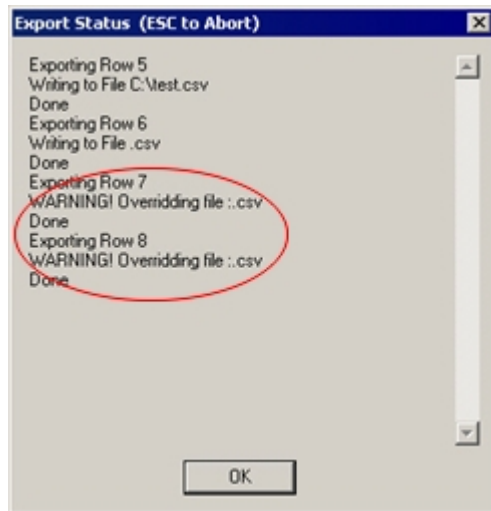

TTank Reference

In the TTank Reference you will find:

An overview of the Tank Monitor workspace.

The Tank Monitor Workspace

The Tank Monitor workspace provides quick and easy access to TTank. Users can view information about TTank activity or perform basic maintenance such as creating new tanks and registering or unregistering existing tanks. The upper right corner of the workspace displays basic information about the tank selected in the Tank box.

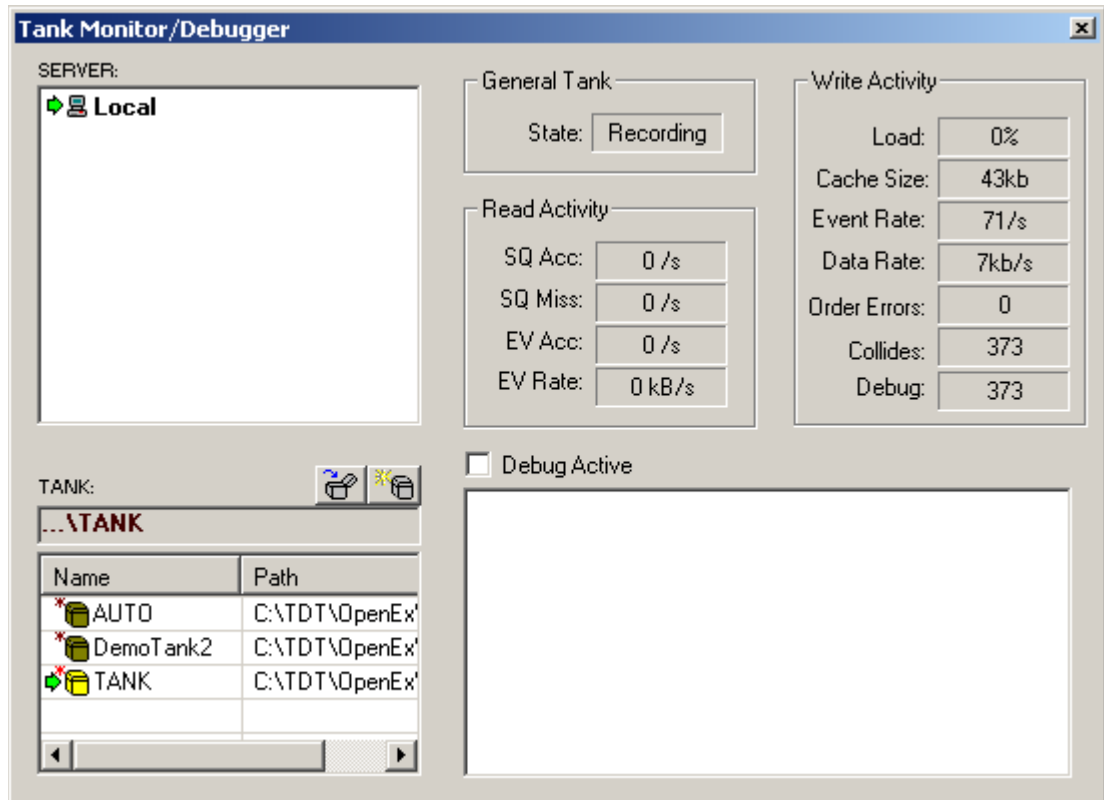

Server Box

In the Server box users can select the server where data tanks can be found or created. In many cases the server will be on the same PC that controls the hardware devices (Local). A green arrow will appear to the left of the server name to indicate that it is selected.

Commands for common tasks such as adding, testing, and removing a server are available from a shortcut menu by right-clicking in the Server box.

Tank Box

In the Tank box users can select or a tank, create a new tank and register or unregister existing tanks. By default, the Tank window list only contains registered tanks that were created with OpenEx 2.0. Right-click in the tank window to bring up a shortcut menu.

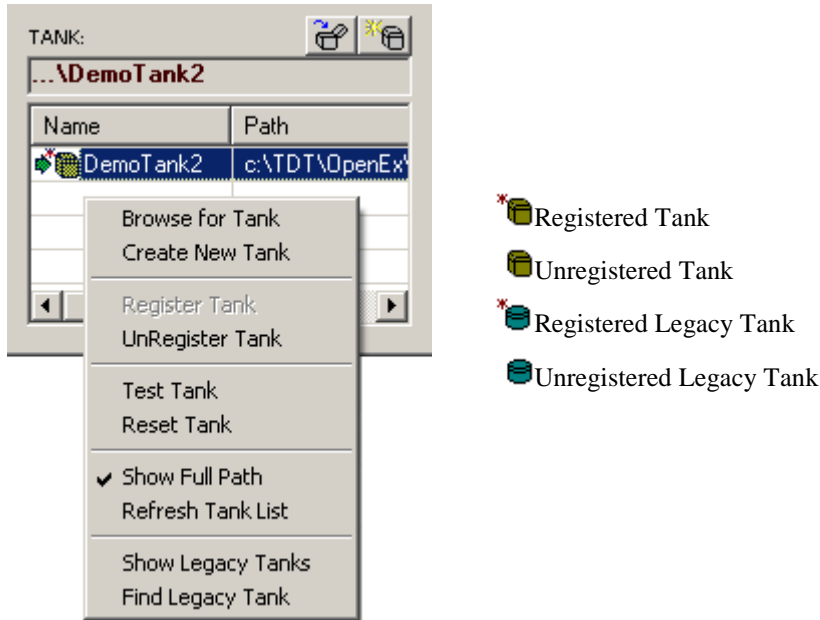

- Browse for Tank** Browse for folder.

- Create New Tank** Opens the Select Tank file dialog box so that a tank can be added. Add Data Tank.

- Register Tank** Adds the selected tank to the Windows Registry.

- UnRegister tank** Removes the selected tank from the Windows Registry. The tank can still be used on the local machine.

- Test Tank** Tests the connection to the server and opens and closes the tank file.

- Reset Tank** Resets the selected tank file.

- Show Full Path** Toggles detail view on and off. In details view the path to the tank is displayed.

- Refresh Tank List** Refreshes the Tank box display.

- Show Legacy Tanks** Displays registered legacy format tanks in the tank list.

- Find Legacy Tanks** Opens the Select Tank File dialog box and allows users to browse for tanks stored in the legacy format by showing files with a .tbk file extension.

Opening an Existing Tank - To open an existing new format tank that is not listed in the tank window, click the Open Existing Tank icon  to open the Browse for Folder dialog and navigate to the desired tank folder. Note: Clicking OK out of this dialog selects the tank and also closes the Select Tank dialog. To open an existing legacy tank, right-click and select **Find Legacy Tank**.

Creating a New Tank - To create a new format data tank, click the Create New Tank icon . This opens the Add Data Tank dialog. Select a path for the data tank folder and provide a unique name for the tank.

Registering/Unregistering a Tank - Users can register or unregister a tank by right-clicking in the Tank box and selecting the appropriate option from the shortcut menu. These actions can be performed on new format and legacy format tanks. Unregistering a tank does not delete the tank files however, only registered tanks will be listed in the Tank window.

Debug Box

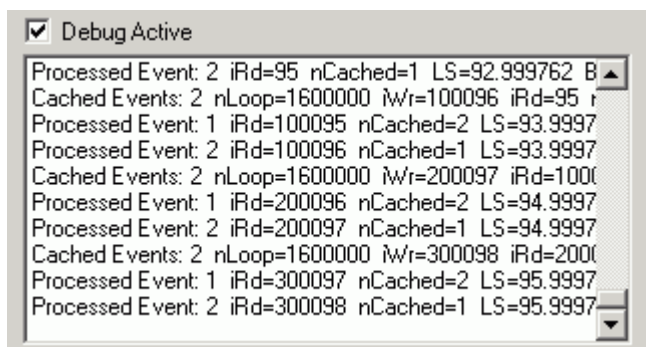

Select the Debug Active check box to see detailed information about tank activity.

Accessing a Tank on Another PC

The TTank server stores and access data in the DataTank. The tank can be accessed across a network, providing the flexibility to accommodate a variety of lab set-ups and work styles. If the user simply wants to store tank data on a networked computer, mapping the network drive on the local computer provides a simple solution. If the user requires simultaneous access to a data tank from more than one computer, issues with each computers security settings must be addressed.

Store tank data across a network...

To use a network resource to store tank data, map the network drive where the tank is to be stored. After creating the tank on the networked computer and registering the tank on the local PC, the user will be able to access the data as if it were stored on the local PC.

To map network drives on your computer, go to **My Computer** and select **Tools > Map Network Drive**. A dialog will help you connect to a shared network folder and assign a drive letter to the connection.

Allow simultaneous access to a data tank from more than one computer...

Security settings need to be modified on both the server and client computers if the user desires simultaneous access to a data tank from more than one computer. One example may be a server computer running an OpenEx project (saving data locally to a tank named DataTank1) and client computers using OpenScope to access the current active block of DataTank1 on the server.

Before software components distributed across networked computers can communicate with each other, several DCOM security settings must be modified on the server computer. The steps below ensure a client computer can access data from a registered new or legacy format tank located on a server computer.

In this example, the computer connected to the TDT hardware is named **TDTServer**. The computer that will run OpenController or TDevAccX remotely has a user account **client1** with password **password1**.

Server computer:

1. In Windows XP, ensure that simple file sharing is disabled.

Open a **My Computer** window. On the **Tools** menu, click **Folder Options**. Click the View tab. Under Advanced Settings, scroll down, and clear the **Use simple file sharing (Recommended)** check box. Click **OK**.

2. Create a user account on the server computer.
 - a. From the **Control Panel**, double-click **Administrative Tools**, and then **Computer Management**. Expand **System Tools**, and then **Local Users and Groups**. Right-click **Users** and select **New User** from the shortcut menu.



- b. The account user name and password must match the client computer's user name and password.

Type the user name (**client1**) and password (**password1**) in the corresponding fields. Clear the **User must change password at next logon** check box, and select the **User cannot change password** and **Password never expires** check boxes. Click **Create** and then click **Close**.

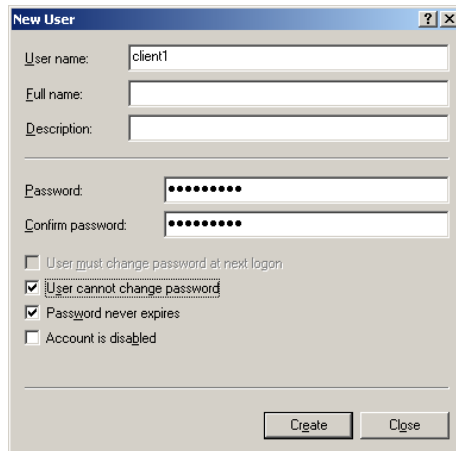

- c. In Windows XP, this account can be a limited user account. *If using Windows XP, skip to step 3.*

In Windows 7, this account must be an Administrator.

- i. To grant administrator privileges in Windows 7 you must add that user to the Administrators group.

In **Computer Management**, expand **System Tools** and then **Local Users and Groups**. Click **Groups**. In the window on the right, right-click the **Administrators** group and select **Add to Group** on the shortcut menu.

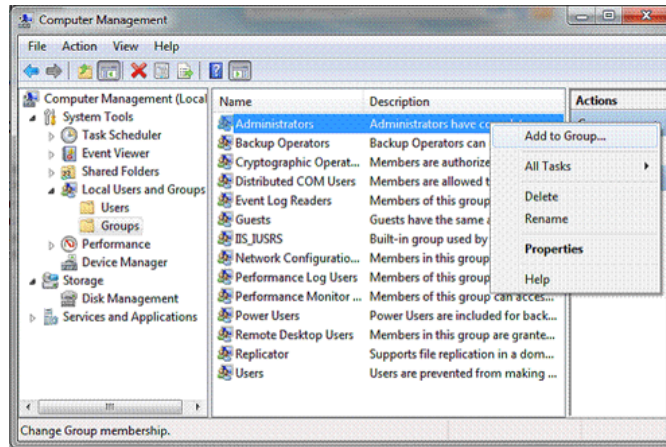

- ii. The Administrators Properties window will open. Click the **Add** button.
- iii. The **Select Users, Computers, Service Accounts, or Groups** window will open. Enter the user name in the **Enter the object names to select** field and click the **Check Names** button. Verify the spelling, and click **OK**.

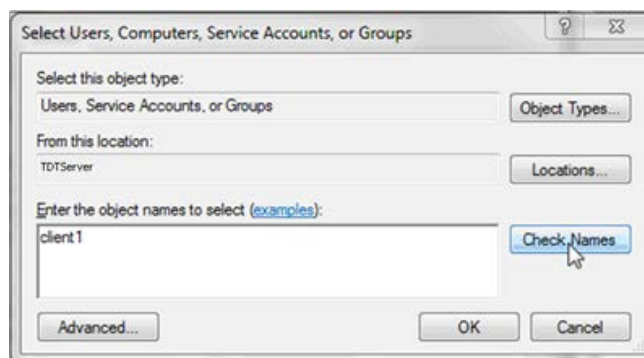

3. Close **Computer Management**.

From the **Control Panel**, double-click **Administrative Tools** and then **Component Services**.

Expand **Component Services**, expand **Computers**, right-click **My Computer** and click **Properties**.

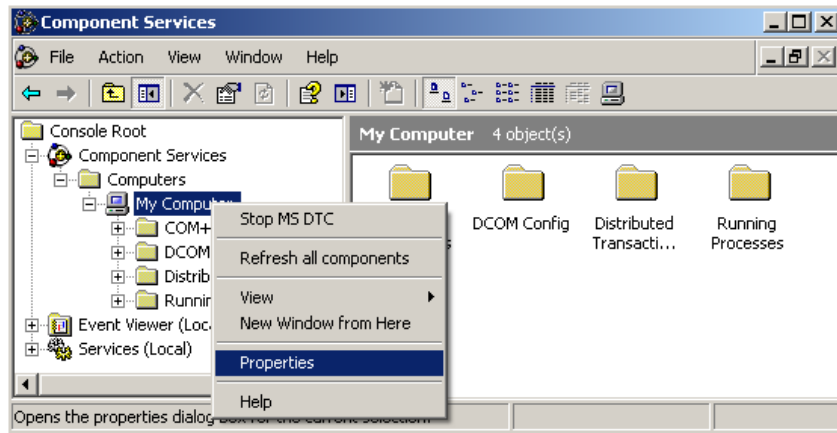

4. In the My Computer Properties window, click the **COM Security** tab.
5. Under Access Permissions, click the **Edit Default** button and then click the **Add** button.

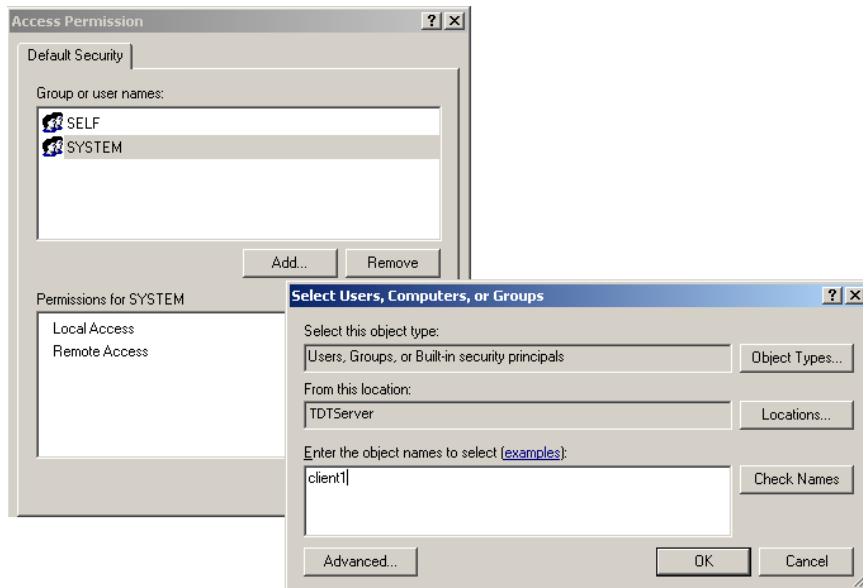

The Select Users, Computers, or Groups window is displayed. In the **Enter the object names to select** field, type **client1**.

Click the **Check Names** button, verify spelling, then click **OK**.

6. In the Access Permissions window, ensure the names **SYSTEM**, **INTERACTIVE**, and **client1** are all present and all have Local Access and Remote Access permission.

If any group names are missing, click Add to enter the group name as before.

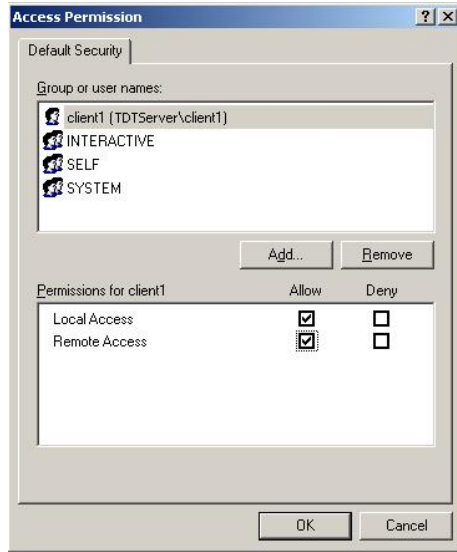

Click **OK**.

- Under Access Permissions in the My Computer Properties window, click the **Edit Limits** button and then click the **Add** button.

In the **Enter the object names to select** field, type **client1**.

Click the **Check Names** button, verify spelling, then click **OK**.

In the Access Permission window, ensure the group names **ANONYMOUS** (or **ANONYMOUS LOGON**), **Everyone**, and **client1** are all present and all have **Local Access** and **Remote Access** permission.

If any group names are missing, click Add to enter the group name as before.

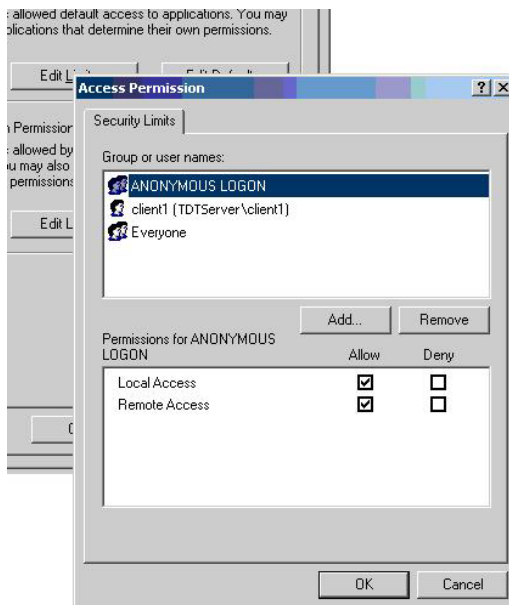

Click **OK**.

8. *If using Windows 7, skip steps 8 and 9.*

In Windows XP, under Launch and Activation Permissions in the My Computer Properties window, click the **Edit Default** button and then click the **Add** button.

In the **Enter the object names to select** field, type **client1**.

Click the **Check Names** button, verify spelling, then click **OK**.

In the Launch Permission window, ensure the group names **SYSTEM**, **INTERACTIVE**, and **client1** are all present and all have **Local Launch**, **Remote Launch**, **Local Activation**, and **Remote Activation** permission.

If any group names are missing, click Add to enter the group name as before.

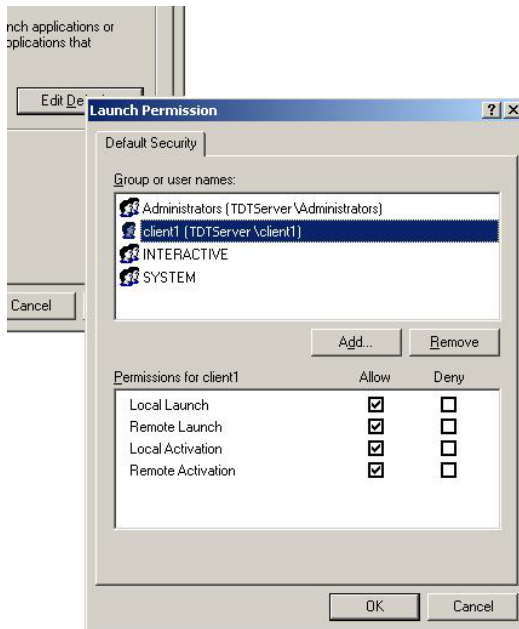

Click **OK**.

9. Under Launch and Activation Permissions in the My Computer Properties window, click the **Edit Limits** button and then click the **Add** button.

In the **Enter the object names to select** field, type **client1**.

Click the **Check Names** button, verify spelling, then click **OK**.

In the Launch Permission window, ensure the group names **Administrators**, **Everyone**, and **client1** are all present and all have **Local Launch**, **Remote Launch**, **Local Activation**, and **Remote Activation** permission.

If any group names are missing, click Add to enter the group name as before.

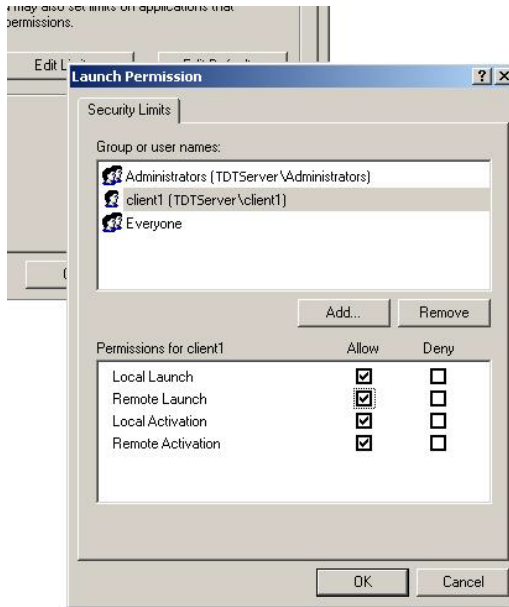

Click **OK**.

- Turn off the windows firewall.

From the Control Panel, open **Windows Firewall**, and select the **Off** radio button. Click **OK**.

- From the Control panel, double-click **Administrative Tools**, and then **Component Services**.

Expand **Component Services**, expand **Computers**, expand **My Computer**, and double-click **DCOM Config** (you can click No if you are asked to record a registry value at this point).

Right-click **XpMaker** and select **Properties**.



- On the Identity tab, ensure that The Interactive User is the account selected to run this application.
- If you would like to simultaneously access the tank data file that is recording in OpenEx through TTankX or OpenScope, repeat steps 11 and 12 for TTankEng in the DCOM Config.

14. After you finished making the security setting changes, reboot the server computer.

Client computer:

1. To test the communication link, ping the server computer from the client computer.
 - a. From the **Start** menu click **Run**, type **cmd**, and click **OK**.
 - b. In the DOS command prompt that opens, type **ping TDTServer**.
 - c. Verify that the server computer was reached and responded to the ping.
2. Add a registry entry with the user name and password of the client computer.
 - a. From the **Start** menu click **Run**, type **regedit**, and click **OK**.
 - b. In the Registry Editor window, expand **HKEY_LOCAL_MACHINE**, **SOFTWARE**, **TDT**, and then **TTank**. Right-click the **EnumServers** folder and select **New String Value**.
 - c. Type the server name (**TDTServer**) as the Value Name and type the user name and password for Value Data in the following form:

*** client1 * password1**

(be sure to include the asterisks and spaces)

- d. After the entry is added, the registry should look like this example below:

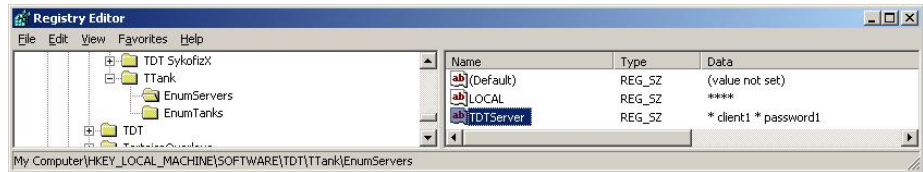

3. While Workbench is running on the server computer, test communication from the client in OpenController.
 - a. Launch **OpenController**
 - b. On the **Edit** menu, click **Window Property**. The Setup Default Properties dialog will open.

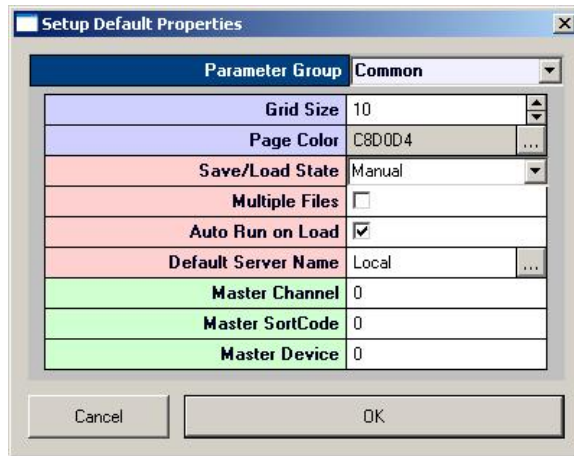

- c. In the **Default Server Name** box, click the browse button to view available servers.

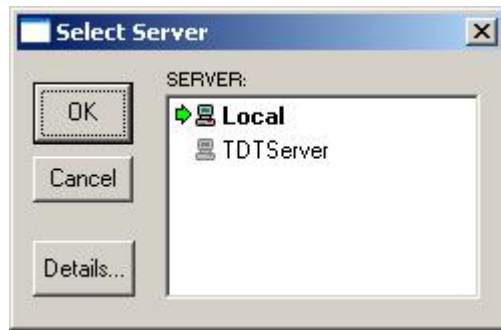

- d. The server name that was entered in the registry is now available. Click **TDTServer** to highlight it, then right-click **TDTServer**, and click **Test Connection** on the shortcut menu.
- e. If the connection was successful, the following message dialog will be displayed:



Click **OK**.

- f. Double-click TDTServer to select it as the default server for Controller.

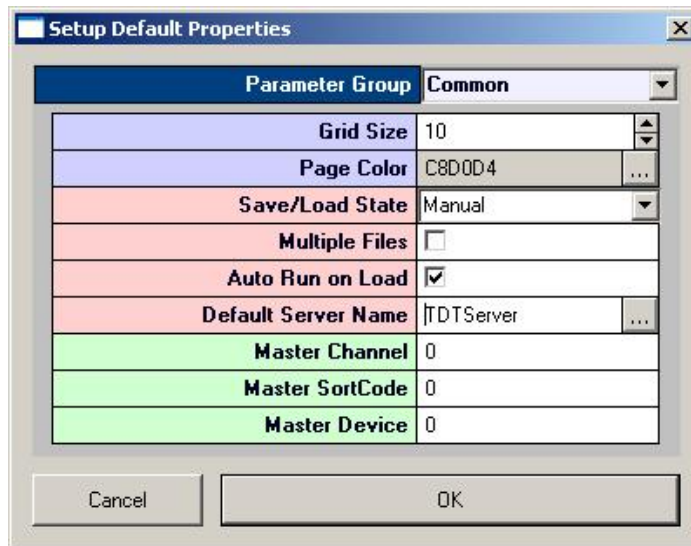

- g. Click **OK**.

You should now have access to the Workbench server running the TDT equipment just like you would if you were running Controller locally on that machine.

4. If you are simultaneously accessing tank data while Workbench is recording, test tank communication from the client in OpenScope.
 - a. Launch **OpenScope**

- b. On the **File** menu, click **Data Source** to open the Select Tank dialog.

Click the **Server** button to open the Select Server dialog.

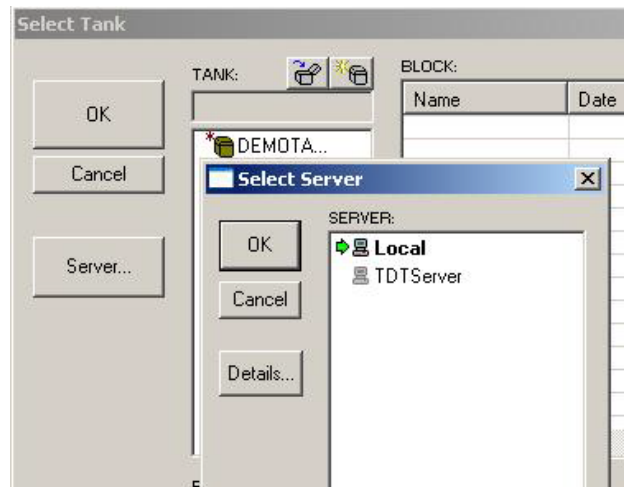

- c. Repeat steps 3d-3f to test communication and select the remote server.

Appendix A – Non Macro Circuit Construct Reference

In this appendix you will find:

OpenEx naming conventions and basic information about RIPvdsEx non-macros circuit constructs.

Overview

In RPvdsEx macros simplify circuit design, allowing the user to 'drop in' pre-debugged circuit chunks guaranteed to provide smooth integration with OpenEx. TDT recommends using macros whenever possible. If a macro is not available for a given task the user must use extra caution to design the circuit with all OpenEx conventions in mind.

OpenEx Naming Conventions

OpenEx uses parameter tags in the compiled circuit file to recognize, change, and record parameter values. OpenEx recognizes and classifies parameter tags using the tag name. Parameter tags fall into three categories:

1. Parameter tags reserved by OpenEx applications for use with Triggering and Control constructs. These cannot be changed.
2. Parameter tags used in Data Stores (Events). These have reserved prefixes but the suffixes are variable. TDT recommends that the suffixes be standardized for better interoperability of circuits.
3. Parameter tags for controls. In many cases controls will be modifying the same parameters in different circuits. For example, control of threshold levels in a spike detection circuit or filter settings for data acquisition will be the same across multiple circuits.

Reserved Tags and Prefixes

The OpenEx naming conventions described below must be followed to ensure that the compiled circuit file will work correctly with OpenEx. The first letter of each tag is a prefix used to classify the tag as a control or data parameter. These prefixes are used in combination with rigid tag names and flexible tag roots to simplify circuit design.



Control Tags

z Reserved

Tag names used by OpenEx controls use the z prefix. If the tag name has a valid OpenEx suffix, OpenEx will send and receive parameter values via the tag. z tags in example files or circuit constructs must be preserved in their entirety. The z prefix should be reserved for OpenEx tags.

Sweep Control

To use the sweep control circuit constructs the following names are required:

zSwPeriod: The period of the sweep duration. This is set in OpenWorkbench and can not be modified during block acquisition. If it is necessary to change this value during the experiment, an asynchronous next sweep control circuit construct should be used. See Asynchronous Next Sweep Control, page 322 for more information.

zSwCount: The maximum number of sweeps before the signal is terminated. If this requires manual or external control, the value should be set to -1 through the OpenWorkbench protocol.

Condition Control

To use the Condition constructs, the following names are required:

zCdPeriod: The period of the sweep duration. This is set in OpenWorkbench and can not be modified during block acquisition. If it is necessary to change this value during the experiment an asynchronous next condition control circuit construct should be used. See Asynchronous Next Condition Control, page 325 for more information.

zCdCount: The maximum number of conditions before the signal is terminated. If this requires manual or external control, the value should be set to -1 through the OpenWorkbench protocol.

Acquisition Control

To use the acquisition control circuit constructs the following name is required:

zAqDur: The duration of the acquisition.

To use the acquisition control circuit constructs with a delay the following name is required:

zAqDelay: The delay for the start of the acquisition.

Stimulation Control

To use the stimulation control circuit constructs, the following name is required:

zStimDur: The duration of the acquisition.

To use the stimulation control circuit constructs with a delay the following name is required:

zStimDelay: The delay for the start of the acquisition.

Data

OpenEx also uses tag roots to group related parameters. The tag root is the suffix used in the parameter tag name. It is identified in the oxScalar, oxSnippet, oxList, oxBuffer, or oxStream component and must be included in each related parameter tag. For example, a related group of parameter tags might be named sFreq, tFreq, and dFreq. These tag roots are used to identify the parameter tags that are associated so that data can be stored to the data tank.

By default, the tag root will be used as the Store ID in OpenWorkbench.

In general, Store IDs should begin with alpha-characters, that is, letters a-z and A-Z. Store IDs must NOT begin with any of the following characters: "-", "=", "(", ")", "<", ">", "!", a space or any number 0 to 9. Keep these limitations in mind when defining the tag root.

The following tag prefixes are used for the stored data:

s Sync

The s prefix identifies the parameter as an index value. Data that is not scalar requires a parameter with an s prefix associated with the buffer to indicate the position of the buffer. This tells OpenEx how many points are to be downloaded to the tank or if any points at all require downloading.

t Time

The t prefix identifies the parameter as a time stamp. Data that is time stamped such as scalars, lists and buffers use a parameter with a t prefix.

d Data

The d prefix identifies the parameter as a data value. All Data constructs require a parameter with a d prefix.

c Coefficient

The c prefix identifies the parameter as a coefficient value.

n Number of Points

The n prefix identifies the parameter as a Npts value.

x Decimation Factor

One tag suffix is used for stored data:

~# Channel Number

The ~# suffix identifies the parameter as part of several channels of data. In the circuit header (oxComponent) you can choose the number of channels associated with the data construct. The number after the tilde is the channel number.

A Brief Review of Terminology

Compiled circuit files are RP control objects, designed by users or TDT, for use with OpenEx and other applications. May be in .rco or .rcx format.

RPvdsEx files contain circuit diagrams designed in a visual drag-and-drop environment. May be in .rpd, .rpx, or .rcx format.

Circuits are made up of components. Each component does a set task, such as generate a waveform, store in memory, or send a signal to device outputs.

Circuit constructs are a group of components that do a defined task in OpenEx. A circuit construct will have a minimum component structure and alternate component structures.

Control Constructs

About Control Constructs

OpenEx is designed for time critical data acquisition and stimulus presentation. To ensure precise triggering of all System 3 hardware devices, a global trigger is sent to each of the System 3 hardware device caddies (zBus). At the simplest level (continuous acquisition) this will start a clock that generates a time stamped output.

All aspects of timing and triggering are controlled by the circuit, or compiled circuit file, running on the System 3 hardware devices.

The non-macro control circuit constructs described in this section can be used in two ways. When a straightforward stimulus and/or acquisition protocol is needed, these constructs can be added to circuits to allow the user to control timing and triggering parameters in OpenWorkbench. When more complex scenarios are needed these circuits offer a starting point for developing more complex control circuits.

Most control constructs use reserved parameter tag names and prefixes to tie construct parameters to the OpenWorkbench settings. When using constructs be sure to preserve the required tag names. When creating new tag names avoid reserved names and prefixes such as the "z" prefix.

See Naming Conventions, page 315 to become familiar with reserved parameter tag names and prefixes.

Basic Triggering and Timing

The main trigger and clock generator constructs provide sufficient triggering and timing control to generate and acquire continuously, such as continuously recording spike data or other waveforms. The minimal circuit consists of a global trigger (zBUS trigger). The trigger ensures that all devices start at the same time. If data storage is required then a clock generator is required. The clock generator starts with the Trigger. Clocks are used to precisely time stamp all data.

The basic triggering and timing constructs are:

- Main Trigger
- Clock Generator
- Secondary Trigger
- Cycle Usage

Main Trigger

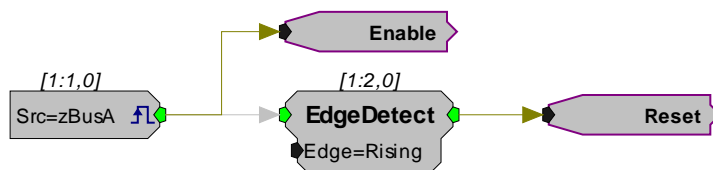

Uses: Each compiled circuit file assigned to a device that will be used by any OpenWorkbench Store must include this construct.

Description: This construct provides the main circuit reset and enable for control across all devices using the zBusA trigger. By default, OpenWorkbench will send a zBusA trigger to all devices when it goes into Preview or Record mode. The trigger stays high until OpenWorkbench is switched to Standby or Idle modes.

Details: zBusA is a feature of the TrgIn component. It generates a synchronized trigger across multiple devices.
 The Enable line (Hop) stays high until halted from OpenWorkbench. This high line is sent to multiple components/circuit constructs to control stimulus presentation, data acquisition, or other actions.
 The Reset line (Hop) is a synchronizing pulse that is sent to multiple components to ensure that all components/constructs are started at the same time.

Clock Generator

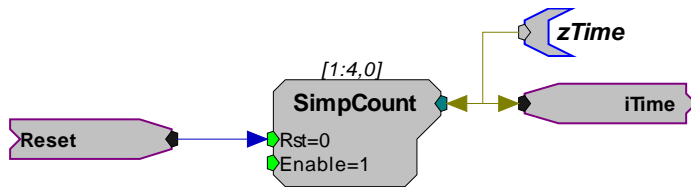

Uses: Each compiled circuit file assigned to a device that will be used by any OpenWorkbench Store must include this construct. The clock generator is used whenever the circuit must read back time to OpenWorkbench.

Description: The clock generator is critical for time stamping data. The clock increments on each tick of the sample clock.

Details: The Reset line is generated by the triggering construct and starts the clock at zero. The clock is reset to zero for each Block in the data tank.
 The output of the SimpCount is used by other constructs to time stamp data via the iTime line. The time value is measured in number of samples since the Reset line went high and is automatically converted to seconds by OpenWorkbench when time stamping data.

OpenWorkbench uses the **zTIME** parameter tag to display the current time and to make sure that the device is running correctly.

Note: The **zTIME** parameter tag is an OpenEx reserved tag name and must be included in this construct.

Secondary Trigger

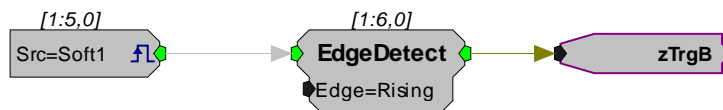

Uses: Used in circuits requiring a secondary software or external trigger. Each compiled circuit file assigned to a device in OpenWorkbench which will use secondary triggering must include this construct.

Description: This construct can facilitate secondary system wide synchronization. It can be used to implement any secondary trigger desired by the user. It can also be used with an asynchronous next sweep (or condition) construct to allow triggering of a next sweep or condition from the z-Trigger-B button in OpenWorkbench.

Details: The zTrgB line can be used to trigger other circuit components. When used with an asynchronous next sweep (or condition) construct an additional output line with a NextSweep (or NextCond) hop should be added.

Cycle Usage

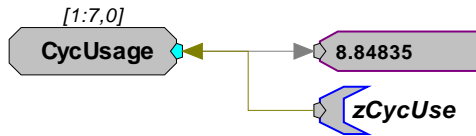

Uses: This is an optional construct that can be added to any compiled circuit file.

Description: This construct allows OpenWorkbench to monitor and display the cycle usage.

Details: The zCycUse parameter tag is used to read the current cycle usage from the CycUsage component for display in OpenWorkbench. The cycle usage is displayed when a protocol is running.

Sweep and Condition Control Constructs

A variety of circuit constructs can be used for precise control of the count, period, and behavior of sweep or condition loops. Sweep and condition loops are used to control the length, start, and end of a stimulus presentation or acquisition. A circuit that does not use sweep or condition control runs continuously. Sweep and condition circuits are triggered either by a trigger or through a user defined paradigm (asynchronous). Sweeps or conditions are used if acquisition or presentation requires a defined length or intervals. Sweep and condition constructs are used by the OpenEx protocols.

The sweep and condition constructs are:

- Basic Sweep Control
- Sweep Control with End Checking
- Asynchronous Next Sweep Control
- Basic Condition Control
- Condition Control with End Checking
- Asynchronous Next Condition Control
- Basic Nesting Control
- Nesting Control with End Tracking

Basic Sweep Control

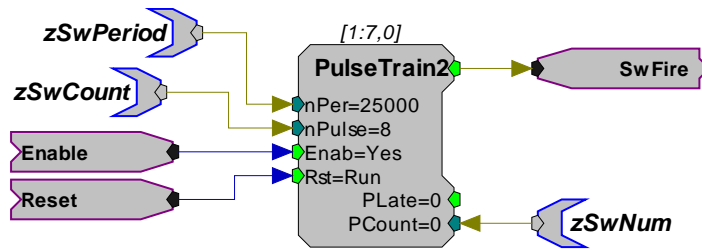

Uses: Used in circuits for basic sweep based control of stimulus or acquisition. The sweep control defines the sweep period and number of acquisitions or presentations. An OpenEx circuit that requires some form of sweep control must use one of the sweep or condition constructs.

Description: This construct allows the user to define the sweep period and the maximum number of sweeps generated during the experimental block through protocol settings in OpenWorkbench.

Details: The Enable and Reset lines are generated by the triggering construct. The SwFire line (Hop) pulses for a single sample to start each sweep and is generally sent to a stimulus or acquisition control construct.

The **zSwPeriod** parameter tag defines the period of the sweep and the **zSwCount** parameter tag defines the number of sweeps. The sweep count will be infinite when the count is set to -1 in OpenWorkbench.

The **zSwNum** parameter tag is an optional tag that points to the current sweep number. When zSwNum is used, OpenWorkbench will display the value on the Block Info sheet while the experiment is running.

Because there is no end checking, the Stop When Done and Standby on Stop protocol settings can not be used with this construct.

Note: The **zSwPeriod** and **zSwCount** parameter tags are OpenEx reserved tag names. These tag names must be included in the construct and must not be altered.

Sweep Control with End Checking

End checking is also provided with:
Asynchronous Next Sweep Control
Nesting Control with End Tracking

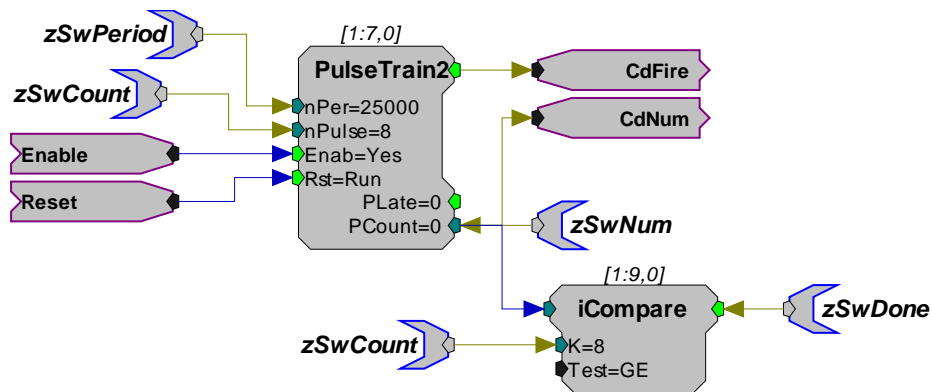

Uses: Used in circuits for basic sweep based control of stimulus or acquisition when end checking is required. End checking can be used to initiate some action at the end of the sweep loop. Each compiled circuit file assigned to a device in OpenWorkbench that will use a sweep must include some form of sweep control construct.

Description: When this construct is used, OpenWorkbench protocol settings can be used to initiate actions, such as stopping the protocol or generating a secondary trigger, when the sweep loop is done.

Details: The **zSwPeriod** parameter tag defines the period of the sweep and the **zSwCount** parameter tag defines the number of sweeps. The current sweep number is compared to the total number of sweeps (zSwCount) to determine when the sweep loop is complete. When this occurs, the output value is set high and this flags OpenWorkbench through the **zSwDone** parameter tag to indicate that the last sweep has been reached.

Using the Standby on Stop check box and the Stop When Done check box under Sweep Loop, the protocol can be set to go to Idle (check boxed cleared) or Standby (check box selected) mode when the **zSwDone** parameter tag value is set high.

A trigger (zTrgB) can also be generated and controlled by the user via the **zSwDone** parameter tag. Control of the trigger is based on settings found under zTrgB Action on Done.

The **zSwNum** parameter tag is an optional tag that points to the current sweep number. When zSwNum is used OpenWorkbench will display the value on the Block Info sheet while the experiment is running.

Note: The **zSwPeriod**, **zSwCount**, and **zSwDone** parameter tags are OpenEx reserved tag names. These tag names must be included in the construct and must not be altered.

Asynchronous Next Sweep Control

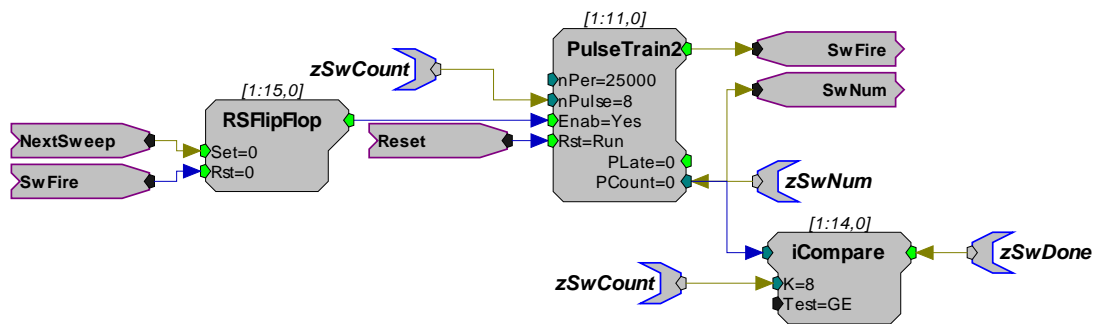

Uses: Used in circuits where manual or external control of the next sweep is required. Each compiled circuit file assigned to a device in OpenWorkbench that will use a sweep must include some form of sweep control construct.

Description: In this construct asynchronous next sweep control is provided by a trigger line which sets a flag to start the next sweep. Once the flag has been recorded the value is reset and the line is ready for the next event. This

construct allows the user to define the maximum number of sweeps generated during the experimental block and control protocol behavior at the end of the sweep loop through protocol settings in OpenWorkbench.

Details:

This construct uses an RSFlipFlop component and two trigger lines. The trigger high line (Set line) sets the output value of the RSFlipFlop high. Once the value has been recorded or the event generated the RSFlipFlop is reset.

Possible inputs for the NextSweep line include an external criterion, such as an external trigger or hardware trigger not generated by OpenWorkbench, or the ZTRGB signal in a secondary trigger construct.

Also, experiments that use changing sweep durations, interstimulus intervals (ISI) and so forth will require timing constructs to trigger the next sweep. The RSFlipFlop acts as a switch to start the PulseTrain2. When a criterion is met the PulseTrain2 fires. The firing of the pulse then resets the RSFlipFlop to zero.

The **zSwCount** parameter tag defines the number of sweeps. **zSwPeriod** is not used in this construct because the sweep durations are not necessarily constant throughout the experiment. Instead the asynchronous next sweep controls the duration and timing of each sweep.

The current sweep number is compared to the total number of sweeps (zSwCount) to determine when the sweep loop is complete. When this occurs, the output value is set high and this flags OpenWorkbench through the **zSwDone** parameter tag to indicate that the last sweep has been reached.

Using the Standby on Stop check box and the Stop When Done check box under Sweep Loop, the protocol can be set to go to Idle (check boxed cleared) or Standby (check box selected) mode when the **zSwDone** parameter tag value is set high.

A trigger (zTrgB) can also be generated and controlled by the user via the **zSwDone** parameter tag. Control of the trigger is based on settings found under zTrgB Action on Done.

The **zSwNum** parameter tag is an optional tag that points to the current sweep number. When zSwNum is used OpenWorkbench will display the value on the Block Info sheet while the experiment is running.

Note: The **zSwCount** and **zSwDone** parameter tags are OpenEx reserved tag names. These tag names must be included in the construct and must not be altered.

Basic Condition Control

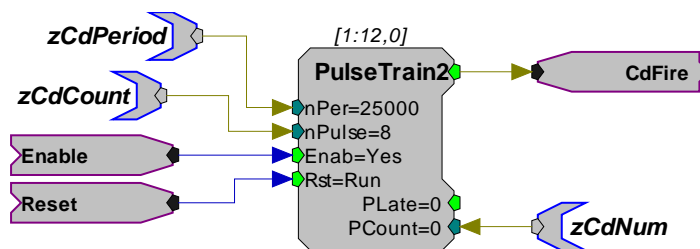

Uses:

Used in circuits for basic condition based control of stimulus or acquisition.

An OpenEx circuit that requires condition control must use some form of condition construct.

Description: This construct allows the user to define the condition period and the maximum number of conditions generated during the experimental block through protocol settings in OpenWorkbench.

Details: The Enable and Reset lines are generated by the triggering construct. The CdFire line (Hop) pulses for a single sample to start each condition and is generally sent to a stimulus or acquisition control construct.

The **zCdPeriod** parameter tag defines the period of the condition and the **zCdCount** parameter tag defines the number of conditions. The condition count will be infinite when the count is set to -1 in OpenWorkbench.

The **zCdNum** parameter tag is an optional tag that points to the current condition number. When zCdNum is used, OpenWorkbench will display the value on the Block Info sheet while the experiment is running.

Because there is no end checking, the Stop When Done and Standby on Stop protocol settings can not be used with this construct.

Note: The **zCdPeriod** and **zCdCount** parameter tags are OpenEx reserved tag names. These tag names must be included in the construct and must not be altered.

Condition Control with End Checking

End checking is also provided with:
Asynchronous Next Condition Control
Nesting Control with End Tracking

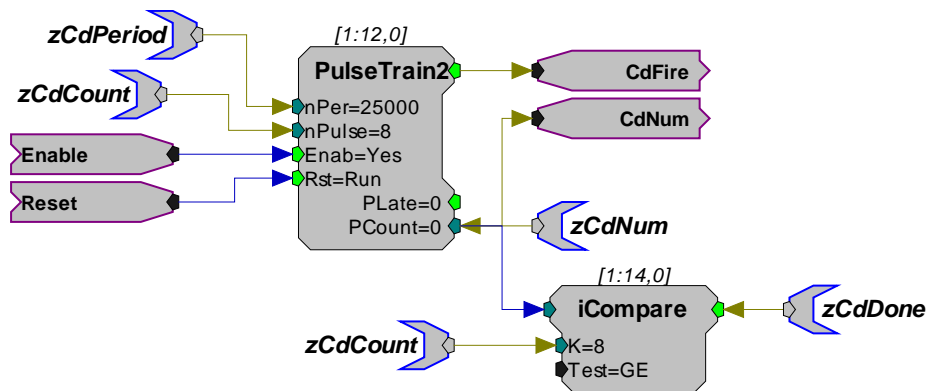

Uses: Used in circuits for basic condition based control of stimulus or acquisition when end checking is required. End checking can be used to initiate some action at the end of the condition loop. Each compiled circuit file assigned to a device in OpenWorkbench that will use a condition must include some form of condition control construct.

Description: When this construct is used, OpenWorkbench protocol settings can be used to stop the protocol when the condition loop is done.

Details: The **zCdPeriod** parameter tag defines the period of the condition and the **zCdCount** parameter tag defines the number of conditions.

The current condition number is compared to the total number of conditions (zCdCount) to determine when the condition loop is complete. When this occurs, the output value is set high and this flags OpenWorkbench, through the **zCdDone** parameter tag, to indicate that the last condition has been reached.

Using the Standby on Stop check box and the Stop When Done check box under Condition Loop, the protocol can be set to Idle (check boxed cleared) or Standby (check box selected) mode when the **zCdDone** parameter tag value is set high.

The **zCdNum** parameter tag is an optional tag that points to the current condition number. When zCdNum is used OpenWorkbench will display the value on the Block Info sheet while the experiment is running.

Note: The **zCdPeriod**, **zCdCount**, and **zCdDone** parameter tags are OpenEx reserved tag names. These tag names must be included in the construct and must not be altered.

Asynchronous Next Condition Control

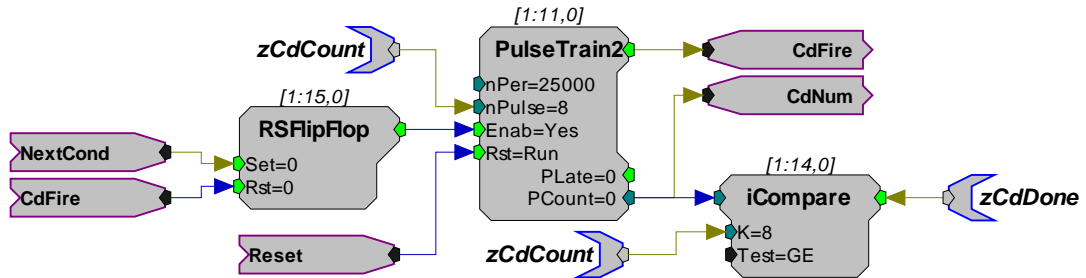

Uses: Used in circuits where manual or external control of the next condition is required. Each compiled circuit file assigned to a device in OpenWorkbench that will use a condition must include some form of condition control construct.

Description: In this construct asynchronous next condition control is provided by a trigger line which sets a flag to start the next sweep. Once the flag has been recorded the value is reset and the line is ready for the next event. This construct allows the user to define the maximum number of sweeps generated during the experimental block and control protocol behavior at the end of the sweep loop through protocol settings in OpenWorkbench.

Details: This construct uses an RSFlipFlop component and two trigger lines. The trigger high line (Set line) sets the output value of the RSFlipFlop high. Once the value has been recorded, or the event generated, the RSFlipFlop is reset and ready to accept the next trigger pulse. Possible inputs for the NextCond line include an external criterion, such as an external trigger or hardware trigger not generated by OpenWorkbench, or the ZTRGB signal in a secondary trigger construct. Also, experiments that use changing sweep durations, interstimulus intervals (ISI) and so forth will require timing constructs to trigger the next condition. The RSFlipFlop acts as a switch to start the PulseTrain2. When a criteria is met the PulseTrain2 fires. The firing of the pulse then resets the RSFlipFlop to zero.

The **zCdCount** parameter tag defines the number of conditions. **zCdPeriod** is not used in this construct because the sweep durations are not necessarily constant throughout the experiment. Instead the asynchronous next sweep controls the duration and timing of each sweep.

The current condition number is compared to the total number of conditions (zCdCount) to determine when the condition loop is complete. When this occurs, the output value is set high and this flags OpenWorkbench through the **zCdDone** parameter tag to indicate that the last condition has been reached.

Using the Standby on Stop check box and the Stop When Done check box under Condition Loop, the protocol can be set to Idle (check boxed cleared) or Standby (check box selected) mode when the **zCdDone** parameter tag value is set high.

The **zCdNum** parameter tag is an optional tag that points to the current condition number. When **zCdNum** is used OpenWorkbench will display the value on the Block Info sheet while the experiment is running.

Note: The **zCdCount** and **zCdDone** parameter tags are OpenEx reserved tag names. These tag names must be included in the construct and must not be altered.

Basic Nesting Control

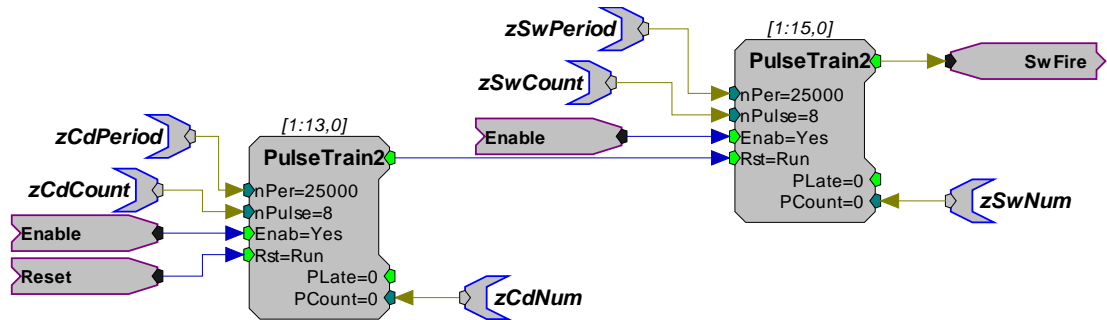

Sweep Nested in Condition

Uses: Used in circuits where both conditions and sweeps are used for either stimulation or acquisition and the count and period for both sweeps and conditions are known. Each compiled circuit file assigned to a device in OpenWorkbench that will use a sweep nested in a condition must include some form of nesting control construct.

Description: This is the simplest form of nesting. Each condition automatically fires the sweeps. The user must make sure the length of the sweeps does not exceed the length of each condition period.

When this construct is used, OpenWorkbench protocol settings can be used to define the sweep and condition period and the maximum number of sweeps and conditions.

Details: The **zCdPeriod** parameter tag defines the period of the condition and the **zCdCount** parameter tag defines the number of conditions.

The **zSwPeriod** parameter tag defines the period of the sweep and the **zSwCount** parameter tag defines the number of sweeps.

The **zSwNum** and **zCdNum** parameter tags are optional tags that point to the current sweep and condition numbers. When **zSwNum** and **zCdNum** are used OpenWorkbench will display the values on the Block Info sheet while the experiment is running.

Note: The **zCdPeriod**, **zCdCount**, **zSwPeriod**, and **zSwCount** parameter tags are OpenEx reserved tag names. These tag names must be included in the construct and must not be altered.

Nesting Control with End Tracking

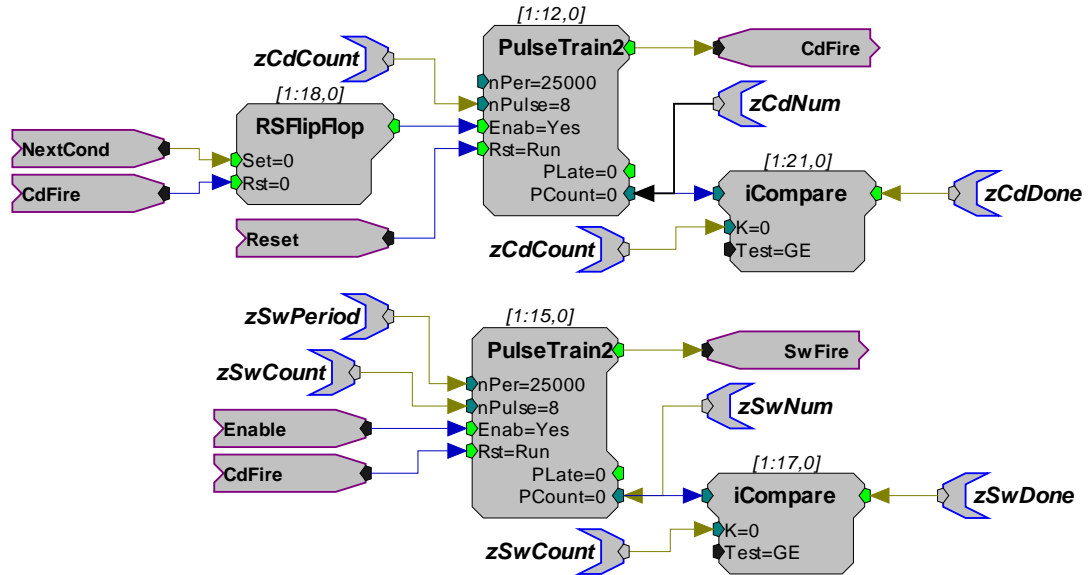

Uses: Used in circuits where both conditions and sweeps are used for either stimulation or acquisition and end checking is required. Each compiled circuit file assigned to a device in OpenWorkbench that will use both sweeps and conditions must include some form of nesting control construct.

Description: When this construct is used, OpenWorkbench protocol settings can be used to determine what action occurs when the sweep and condition loops are done.
 Using the Standby on Stop check box, and the Stop When Done check box for the condition loop, the protocol can be set to Idle (Standby on Stop check boxed cleared) or Standby (Standby on Stop check box selected) mode when the **zCdDone** parameter tag value is set high.

Details: The **zCdPeriod** parameter tag defines the period of the condition and the **zCdCount** parameter tag defines the number of conditions.
 The **zCdCount** parameter feeds into the iCompare component within the condition loop which counts the number of pulses generated. When this reaches the iCompare K value the output value is set high and this flags OpenWorkbench through the **zCdDone** parameter tag to indicate that the last condition has been reached.
 The **zSwPeriod** parameter tag defines the period of the sweep and the **zSwCount** parameter tag defines the number of sweeps.

The NextCond line can be connected to the final iCompare to automatically increment on the end of each set of sweeps. The NextCond line could also be connected to a secondary trigger construct to allow manual or computer control of the next condition.

A trigger (zTrgB) can also be generated and controlled by the user via the **zSwDone** parameter tag. Control of the trigger is based on settings found under zTrgB Action on Done.

The **zSwNum** and **zCdNum** parameter tags are optional tags that point to the current sweep and condition numbers.

When zSwNum or zCdNum is used OpenWorkbench will display the value on the Block Info sheet while the experiment is running.

Note: The **zCdPeriod**, **zCdCount**, **zSwPeriod**, **zSwCount**, **zCdDone**, and **zSwDone** parameter tags are OpenEx reserved tag names. These tag names must be included in the construct and must not be altered.

Acquisition and Stimulation Control Constructs

Circuit constructs are also provided for precise control of the timing (duration and delay) of acquisition, presentation, and other events.

The constructs are:

- Basic Acquisition Control
- Basic Stimulation Control
- Other Event Control

Basic Acquisition Control

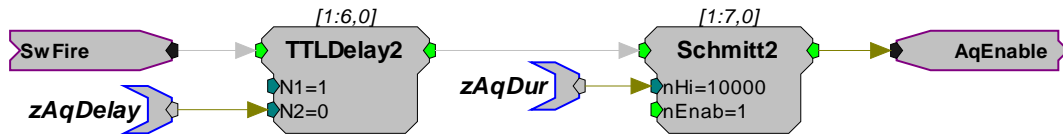

Uses: Used in circuits where sweep based acquisition will occur and the user will set the acquisition delay or duration. Each compiled circuit file assigned to a device in OpenWorkbench that will be used for data acquisition must include some form of acquisition control construct.

Description: This construct allows the user to control the delay and duration of acquisition from OpenWorkbench protocol settings.

Details: The SwFire line is generated by the sweep control construct. The AqEnable line (Hop) will trigger buffers for acquiring data.

The **zAqDelay** parameter tag defines the length of the delay for the start of the acquisition relative to the beginning of a condition or sweep and the **zAqDur** parameter tag defines the duration of the acquisition.

Note: The **zAqDelay** and **zAqDur** parameter tags are OpenEx reserved tag names. These tag names must be included in the construct and must not be altered.

Basic Stimulation Control

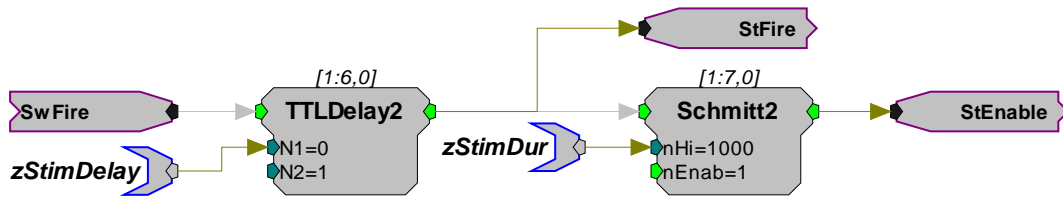

Uses: Used in circuits where stimulation will occur and the user will set the stimulation delay or duration. Each compiled circuit file assigned to a device in OpenWorkbench that will be used for stimulus presentation must include some form of stimulation control construct.

Description: This construct allows the user to control the delay and duration of stimulus presentation from OpenWorkbench protocol settings.

Details: The SwFire line is generated by the sweep control construct. The StEnable line (Hop) will control gates for turning stimuli on and off.

The **zStimDelay** parameter tag defines the length of the delay for the start of the stimulus relative to the beginning of a condition or sweep and the **zStimDur** parameter tag defines the duration of the stimulus.

Note: The **zStimDelay** and **zStimDur** parameter tags are OpenEx reserved tag names. These tag names must be included in the construct and must not be altered.

Other Timing Control

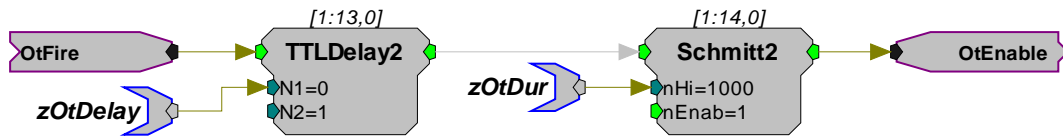

Uses: Used in circuits where the user will control the timing (delay or duration) of some other circuit or device. Each compiled circuit file assigned to a device in OpenWorkbench that will be used for this other occurrence must include an other timing control construct.

Description: This construct allows the user to control delay and duration of an alternate timing control option.

Details: The OtFire line is generated by the sweep control construct. The OtEnable line (Hop) will control gates for turning a timed event on and off.

The **zOtDelay** parameter tag defines the length of the delay for the start of the timed event relative to the beginning of a condition or sweep and the **zOtDur** parameter tag defines the duration of the event.

Note: The **zOtDelay** and **zOtDur** parameter tags are OpenEx reserved tag names. These tag names must be included in the construct and must not be altered.

Data Storage

When it is necessary to use a non-macro data construct, the user must take extra care to understand all the details of data construct design. Circuit headers within each data construct contain all the necessary information for OpenWorkbench to be able to retrieve the data from the hardware and store it in a data tank on the computer's hard drive.

Headers, such as OxSnippet and OxStream, are the link between OpenWorkbench and the waveforms or data being acquired by the device. They give Workbench and TTankEngine information about the waveforms and what kind of data to expect, at what rate, in what form, and so forth. If there is a mismatch between the attributes of the signal specified by the header and the actual data being transferred to the PC, then OpenWorkbench will generate timing errors. So, it is important to use the correct parameters in these headers.

Circuit headers are a special type of processing component. In RPvdsEx, they are grouped in the OpenEx Headers components category. There are five data generating constructs that can be used with OpenEx, and each one requires a different type of circuit header.

The five data constructs used in OpenEx are:

- Type 1: Triggered Scalar (uses the oxScalar circuit header)
- Type 2: Data Buffer (uses the oxBuffer circuit header)
- Type 3: Data List (uses the oxList circuit header)
- Type 4: Signal Snippet with and without spike sorting (uses the oxSnippet circuit header)
- Type 5: Continuous Waveform (uses the oxStream circuit header)

The circuit headers for each data type contain different pieces of information. However, all of them include a tag root. The tag root is a name that will be used by OpenWorkbench to access the data, time stamps, and other information associated with the data construct. All of the data constructs require a parameter tag to access the data. To do this, OpenWorkbench will look for a parameter tag with the name $d + (\text{tag root})$. For example, if the tag root is *Freq* then it will look for the tag *dFreq*. Depending on the type of data construct being used, other tags will be required as well, including sync parameters (s tags) and time stamps (t tags). For the tag root *Freq* these would be *sFreq* and *tFreq*. When storing multiple channels, suffixes may be used with these parameter tags as well. More detail about each of these tags can be found in the OpenEx naming conventions and in the documentation for each particular data construct.

When discussing data constructs it is also important to mention secondary tags. Secondary tags are a way of sharing time stamps when storing pieces of data that are always stored at the same time. For example, if a complete construct with circuit header is set up for saving the sweep number parameter, other stimulus parameters can be saved at the same time (with the same time stamp) by listing them as secondary tags. There are several methods for using secondary tags. For more information see Secondary Tag Constructs, page 342.

Data Construct Types

Type 1: Triggered Scalar

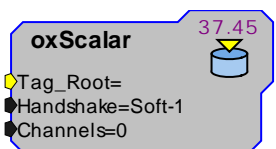

About the oxScalar component ...

Tag_Root identifies the base name of the construct. All parameter tags in the circuit that use the base name will be associated with the oxScalar component.

HandShake indicates whether a software trigger will be used for the handshake. The handshake is a communication procedure between the application and the compiled circuit file. A flag is set high to indicate the data has been acquired. The application acquires the data and time stamp and then resets the flag for the next stimulus. If the handshake value is set to None, OpenWorkbench polls for changes in the time stamp parameter tag (t prefix) and then stores the data when the time value changes.

Channels is the number of channels associated with the scalar. For single mode the value is set to 0.

Uses: The triggered scalar data construct is used when storing asynchronous scalar data that arrives at a rate no greater than once per second. Examples of asynchronous data include sweep numbers, stimulus parameter, and digital input values. Each compiled circuit file assigned to a device, in OpenWorkbench, that will be used to acquire asynchronous scalar data must include this construct.

Description: With a triggered scalar data construct, data values are latched (using the Latch component) each time they need to be stored. Periodic timing can be used (For example, latch the data once every five seconds) or other timing methods can be used (for example: latch the data when an external trigger arrives at the device). A time stamp value must be latched at the same time as the data is latched, so that the data and time will be associated when stored in the tank. OpenWorkbench reads the data and time values when polling the hardware device. After reading the values and storing them to the tank, it will reset the latch (if using a handshake protocol) or continuously read the values and only save them when they change. The triggered scalar should only be used when the data arrives at a rate less than once per second. If scalar data values must be stored more frequently, a data list (Type 3) construct must be used instead.

Details: Each data buffer must include parameter tags using the tag root with the following prefixes and suffixes:

- t prefix for the time stamp parameter
- s prefix for the sync parameter
- d prefix for the data tags that are stored

Handshaking is optional. If there is no handshake, the latching of the time occurs through OpenWorkbench polling. OpenWorkbench polls for changes in the time stamp parameter tag (t prefix) and then stores the data when the time value changes.

The example below uses a triggered scalar construct with handshaking to store the sweep number. On each sweep, the Counter is incremented, changing the value of the **dSweep** tag. Also the latch is triggered, which stores the current time value via **tSweep**. Since handshaking is being used, OpenWorkbench will look for the **sSweep** tag to be set high when new data has arrived. So, also on each sweep, the RSFlipFlop is set, which causes **sSweep** to be equal to 1. After

OpenWorkbench reads the data and time values, it issues a Soft-1 trigger, which resets the RSFlipFlop and **sSweep** becomes 0. Notice that Soft-1 is set as the handshake trigger in the oxScalar component. If multiple triggered scalar constructs with handshaking were used in the circuit, a different software trigger would be used for each of them.

Additional data values can be associated with this scalar and may also be stored to the tank. These values are called secondary tags. See Secondary Tags, page 69 for more information.

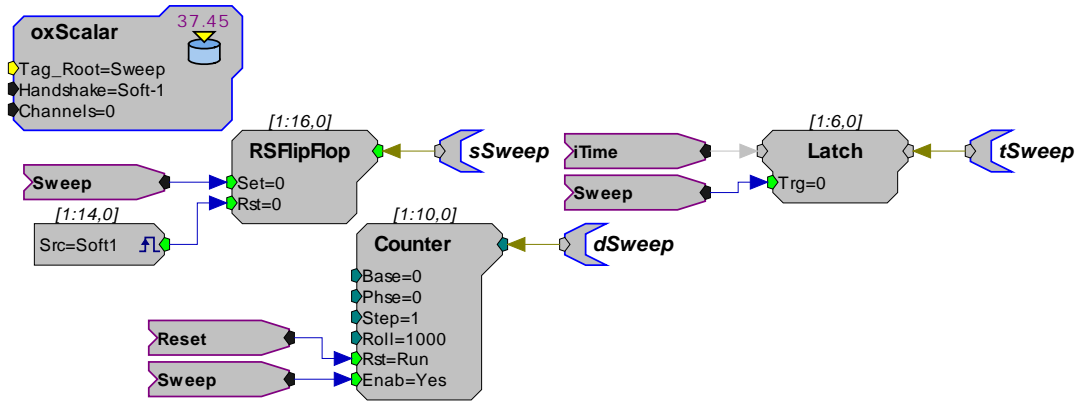

Type 2: Data Buffer

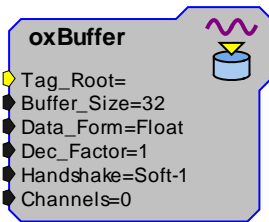

About the oxBuffer component ...

Tag_Root identifies the base name of the construct. All parameter tags in the circuit that use the base name will be associated with the oxBuffer component.

Buffer_Size indicates the number of points in the data buffer. This can be a fixed value; however in many cases the buffer size may be dependent on the timing construct. Then it is convenient to use a parameter tag to specify the buffer size. This is done by setting Buffer_Size to 0 in the oxBuffer and using a parameter tag with the prefix 'n' to specify the size of the buffer.

Data_Form is the format of the data. The data type can be float (32-bit), integer (32-bit), short (16-bit integer), or byte (8-bit integer).

Dec_Factor is the decimation factor. If the data is reduced either through a Plot16dec or through changes in the time-slice then a decimation factor other than one should be used.

HandShake indicates whether a software trigger will be used for the handshake. The handshake is a communication procedure between the application and the compiled circuit file. A flag is set high to indicate the data has been acquired. The application acquires the data and time stamp and then resets the flag for the next stimulus.

If the handshake value is set to None, OpenWorkbench polls for a change in the time stamp parameter tag and then stores the data when the time value changes.

Channels is the number of channels associated with the buffer.

Uses:

The data buffer construct is used when storing a block of data points that are not continuously streaming. Examples of data buffers include signal averages for evoked potentials and fixed-duration blocks of acquired data (such as one

second worth of data after each stimulus). Each compiled circuit file assigned to a device, in OpenWorkbench, that will be used to acquire a data buffer must include this construct.

Description: With a data buffer, a waveform and associated time stamp are stored to the data tank. Each time a block of data is acquired into the buffer, the time stamp value should be latched so that it contains the time of the first data point in the buffer. If handshaking is used, a sync parameter tag should also be set high after the buffer has filled up. OpenWorkbench will then read the data and time stamp and reset the sync parameter tag.

Details: Each data buffer must include parameter tags using the tag root with the following prefixes and suffixes:

t prefix for the time stamp parameter

A Latch component acquires the time stamp from the Clock Generating construct.

s prefix for the sync parameter

A parameter tag with the s prefix is used if handshaking is enabled for the construct.

It will be set high when data has been acquired into the buffer and needs to be stored to the tank.

n prefix for the number of points

If the Buffer_Size of the oxBuffer is set to 0, then OpenWorkbench will look for a parameter tag with the n prefix to determine the number of points in the buffer. This tag value should take into account any decimation factor including Plot16Dec and time slices. If a timeslice is used, make sure that all constructs use the same timeslices (see the RpvdsEx Help section on timeslices).

d prefix for the data tags that are stored

This tag may also include a suffix with a tilde and a number if there are multiple acquisition channels.

In this example the data is acquired and stored to the tank on each sweep.

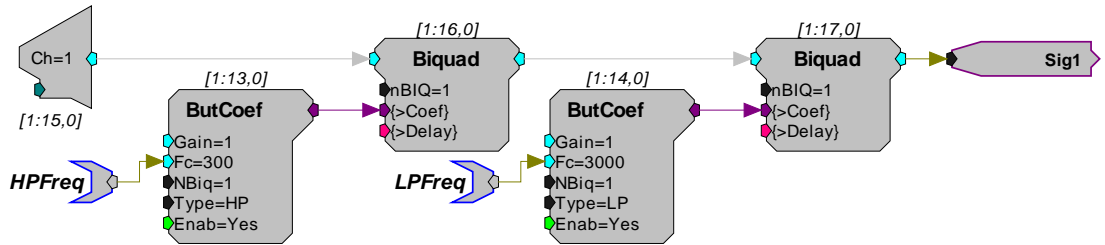

The acquired signal is filtered and a signal line is connected to the Stores input.

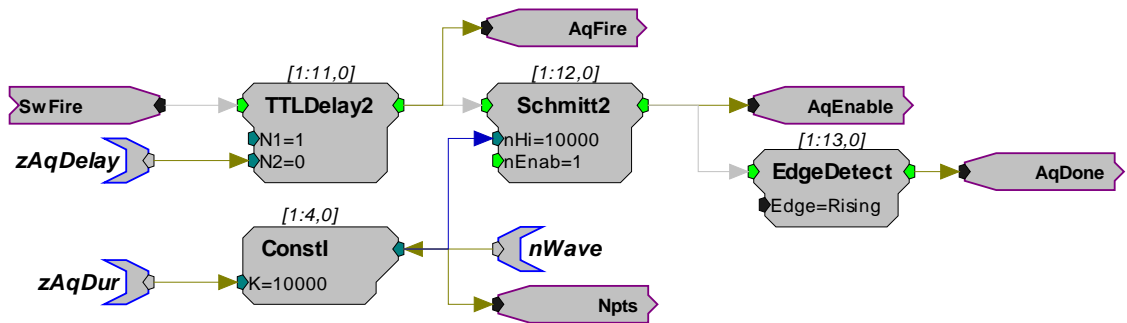

A timing circuit controls the duration and calculates the number of points.

This circuit differs from the simple timing circuit. It contains an AqFire which is used by the handshaking protocol. It also has the n prefix parameter tag and Npts for determining the number of points in the buffer. An EdgeDetect triggers the end of the acquisition pulse.

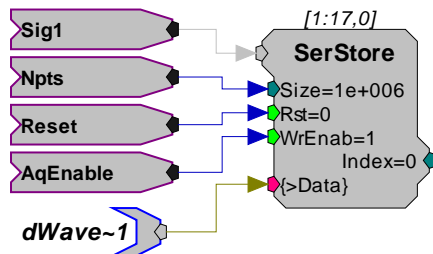

The store component is a SerStore.

Signal data is acquired when the AqEnable line from the acquisition timing circuit is set high. This is high for the duration of the acquisition. The size of the Store is indicated by the Npts line and is determined by the acquisition timing circuit (above). The Reset line resets the buffer at the start of a new block of acquisition.

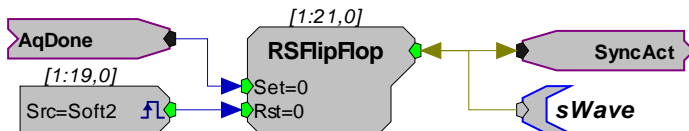

The AqDone line sets the RSFlipFlop high when the acquisition ends. While polling, OpenWorkbench will detect the sWave high. It will then acquire and store the buffered variable dWave and the associated time stamp. Once the data is acquired the RSFlipFlop is reset by the handshake protocol.

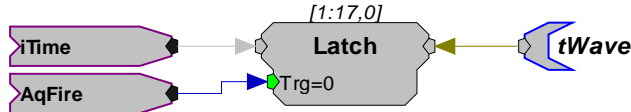

The Latch buffer uses the Time line from the clock generating construct and the AqFire line to time stamp the start of the acquired buffer.

Type 3: Data List

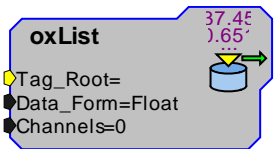

About the oxList component ...

Tag_Root identifies the base name of the construct. All parameter tags in the circuit that use the base name will be associated with the oxList component.

Data_Form is the format of the data. The data type can be float or integer (both are 32-bit).

Channels is the number of channels associated with the list.

Uses: The data list construct is used when storing scalar data that can arrive at rates greater than the polling rate of OpenWorkbench. Examples of data lists include sweep numbers, stimulus parameters, and digital input values. Each compiled circuit file assigned to a device, in OpenWorkbench, that will be used to generate a stimulus using the list must include this construct.

Description: A data list involves two buffers – one for the data and one for the associated time stamps. A timing construct must be set up so that both of the buffers are enabled for writing a single sample each time a data value must be saved. The sync parameter tag should be connected to the Index of one of the buffers. Each time OpenWorkbench polls the device, it will check to see if the index has changed, and if so it will store the new data and time stamp values. Data lists are not dependent on the polling rate of OpenWorkbench for acquiring signals because they can store multiple data points in between polls.

Details: Each data list construct must include parameter tags using the tag root with the following prefixes and suffixes:

- t** prefix for the time stamp parameter
- s** prefix for the sync parameter
- d** prefix for the data tags that are stored

If several pieces of data need to be stored at the same time (for example: saving several stimulus parameters such as frequency, level, and duration) each one can be stored as a different channel or they can be saved as secondary tags. A suffix of a tilde and a number indicate multiple channels for the data list.

No handshaking is used with data lists because OpenWorkbench will always need to look at the current buffer index to determine how much data needs to be stored.

In this example the intensity and frequency of a time stimulus are changed in rapid fashion on each stimulus sweep. The output signal is a gated tone to channel 1 of a System 3 device.

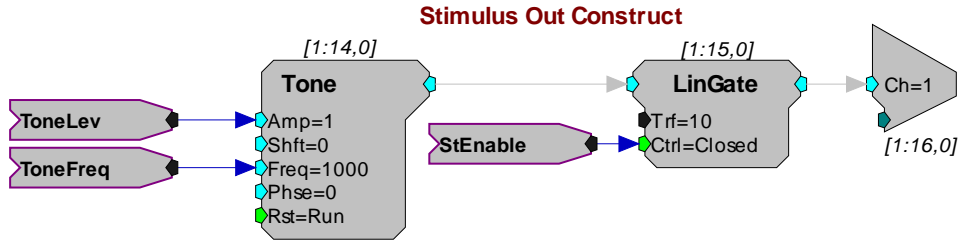

The gated signal out is created using the Tone and LinGate components.

Tone frequency and level are controlled by a list of variables (see following diagram).

The gate opens when the StEnable line is set high (see the Basic Stimulation control construct).

List of Levels and Frequencies

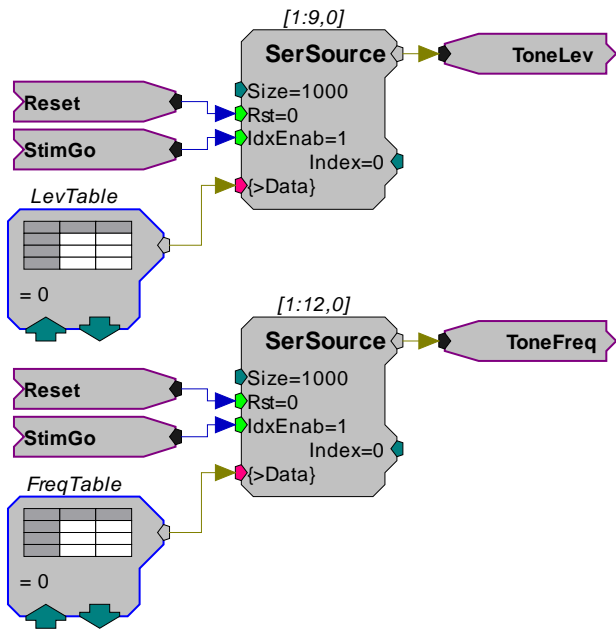

Levels and frequencies are loaded into memory buffers from data tables. A SourceFile component or parameter tag would also work.

The Reset line is generated from the trigger construct and resets the list after each block is recorded.

The StimGo line is generated from the TTLDelay2 component of the stimulus timing construct. This produces a single pulse to move the memory buffer to the next list before the next tone.

The ToneFreq and ToneLev lines go to the Tone component and the scalar list Stores.

The oxList data construct in this example consists of a time stamp value and sFreq list. Note that as with a continuous waveform construct, only one s variable is required.

The time stamp and all channel values will have the same sequence position in each of the buffers.

The data Store contains the variable information for the list. In addition, secondary tags can be added that are stored with these values (See Secondary tags, page 69).

The secondary tag has a different Tag_root from the primary Stores.

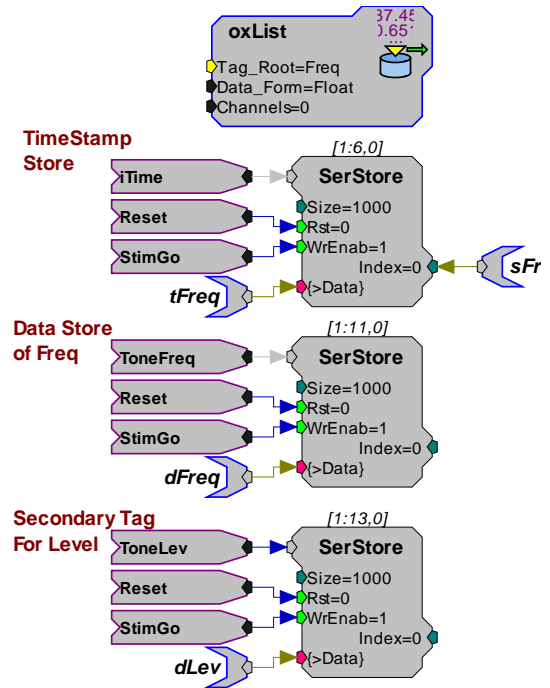

Type 4: Signal Snippets

Also see Signal Snippets with Spike Sorting, page 339.

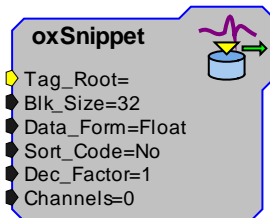

About the oxSnippet Component...

Tag_Root identifies the base parameter name. Parameter tags in the circuit that use the base parameter name will be associated with the oxSnippet component.

Blk_Size indicates the block size of the snippet acquired. The value set here needs to match the width of the snippet as defined by the spike detection component (or processor type), such as SortSpike, SortSpike2, SortSpike3, or FindSpike.

Data_Form is the format of the data. Most snippet data is in floating point format, making use of the full resolution of the system. However, other data types can be in integer, short, or byte. This value must be configured correctly for the data type or tank values will be incorrect.

Sort_Code is a flag that determines whether or not a sort code should be stored with spike data. This parameter should be set to Yes when using a spike acquisition component which generates a sort code for each snippet stored, such as SortSpike, SortSpike2, and SortSpike3. It should be set to No when using components that do not generate a sort code, such as FindSpike and Tetode. Specifying Yes when no sort code is generated will result in erroneous data being stored as the SortCode. Specifying No when a sort code is generated will result in the sort code data not being stored. Form more information on spike sorting see Signal Snippets with Spike Sorting, page 339.

Dec_Factor is the decimation factor when data is stored at a lower rate than the devices sampling rate.

In most cases snippet data will not require decimation and this will be set to 1.

Channels is the number of channels of snippets being stored.

Uses: Each compiled circuit file assigned to a device, in OpenWorkbench, that will be used to acquire snippet data must include this construct.

Description: The signal snippet stores a waveform and its associated time stamp in to the data tank. The value is read from a buffer that stores the waveform(s) and the associated time stamp each time OpenWorkbench is polled. When used with multiple channels, data acquired at different rates and times (asynchronously) can be stored.

Details: Each signal snippet must include parameter tags using the tag root with the following prefixes and suffixes:

s prefix for the sync parameter

d prefix for the data tags that are stored

This tag may also include a suffix with a tilde and a number if there are multiple acquisition channels.

For example, dPD~1, dPD~2, sPD~1, and sPD~2 would be used for two channels of associated data using the tag root PD.

Before the circuit is stored as a compiled circuit file the number of channels is checked by comparing the tilde values to the oxSnippet buffer value.

The example below shows two channels of snippet data from a FindSpike. FindSpike acquires candidate spikes using a threshold level that is compared to the RMS of the background signal. Candidate spikes are time stamped (timeline below) and stored to a buffer. Because each channel will have different spike patterns, a separate sample position parameter with the s tag prefix is required for each channel. Separate data parameters with the d tag prefix are also required. No time parameter tag is needed since the data structure contains the time stamp.

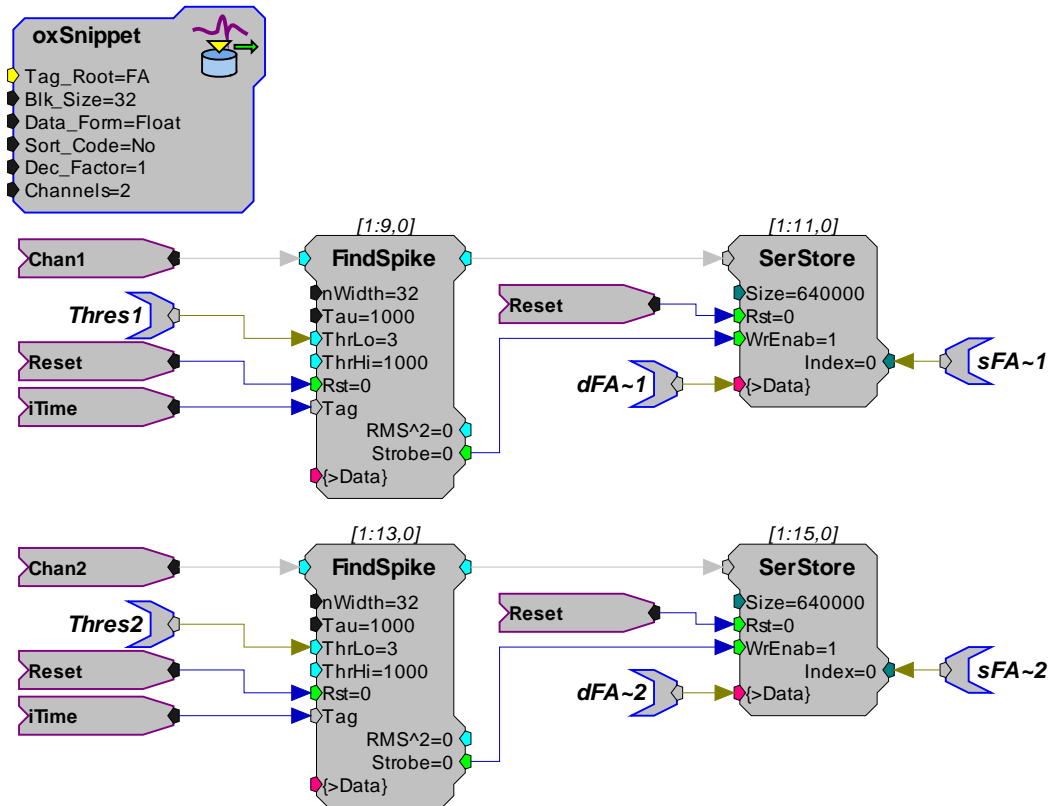

Type 4: Signal Snippets with Spike Sorting

See Type 4: Signal Snippets, page 337 for information about the oxSnippet component.

Spike sorting components generate a sort code for events that pass through a window discriminator and a voltage range at a set time.

Uses: Used with Sort Spike Control to store waveforms that differ in shape based on the voltage of the signal at a set point in time.

Description: Used as part of a signal snippet data construct. Stores a spike event and sort code for each snippet. Data can then be exported with the sort code and the time stamp.

Details: Each spike sorting construct must include parameter tags using the tag root with the following prefixes:

- a prefix for the lower voltage threshold
- b prefix for the upper threshold
- c prefix loads the SortSpike coefficients to the component. The coefficients are generated in OpenController and contain the time and voltage range for each hoop (time-amplitude window discriminator) added in the Snippet Sort control.

SortSpike Variation

The SortSpike component must have the following organization:

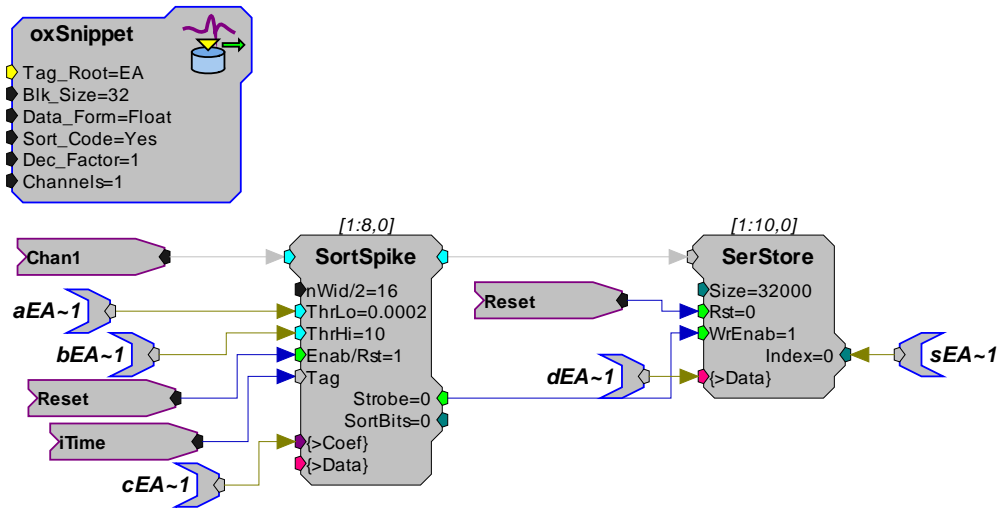

SortSpike2 Variation

This construct can also use a SortSpike2 component in place of SortSpike. SportSpike2 works similarly but specifies only a lower voltage threshold value and allows for spike detection outside of a range [-threshold, +threshold]. In this construct the prefix a, is used for the parameter tag that controls the threshold. The threshold parameter is also affected by the Use Sign parameter. If Use Sign is set to one any sign entered with the Thresh value is disregarded and the value is considered to be a +/- number. If set to zero, Thresh value sign is considered. This construct can be further modified for use with a SortSpike3 component. Users should be aware of the limitations of SortSpike3 when using it within the OpenEx environment.

Note: there is no b prefix parameter tag with this construct.

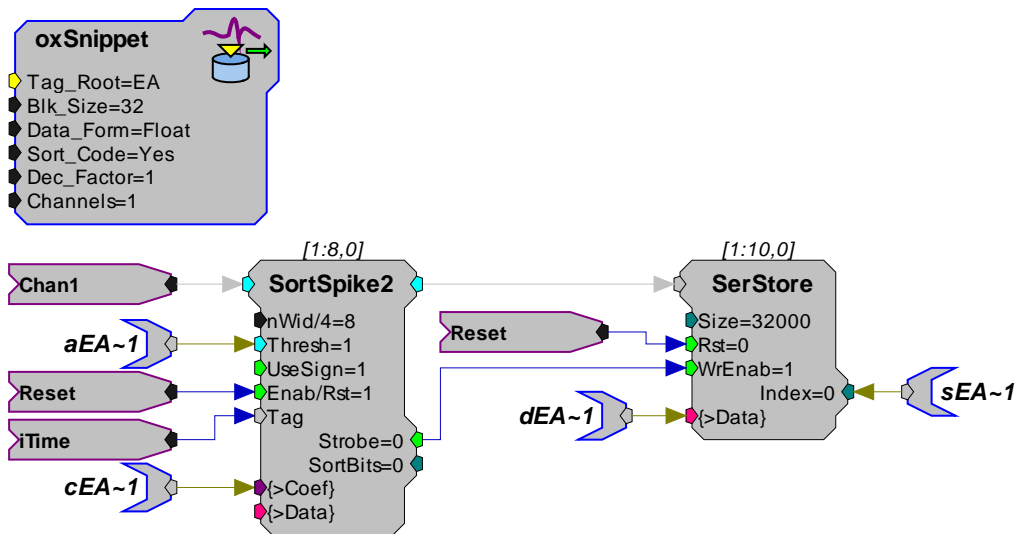

See also Choosing a Spike Component, page 71.

Type 5: Continuous Waveform

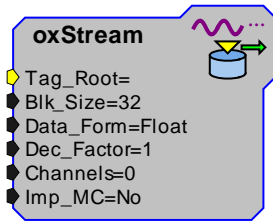

About the oxStream Component ...

Tag_Root identifies the base name of the construct. All parameter tags in the circuit that use the base name will be associated with the oxStream component.

Blk_Size indicates the block size (data is acquired by the DSP in small packets, or blocks) of the stream acquired and specifies the size of each scroll section. Block size is arbitrary but the block should be small enough for easy download to the tank and large enough to minimize the cycle usage associated with continuously streaming small chunks of data to disk. Too large a block size will also make a scroll plot look choppy.

Important Notes:

Blk_Size cannot be more than 265 if the stream is being used in Controller for spike thresholding. The size of the buffer storing the signals needs to be an even multiple of **Blk_Size**.

Data_Form is the format of the data and depends on the resolution of the stored data. This value must be configured correctly for the data type or tank values will be incorrect.

If the data is being stored in 16-bit resolution (usually when passed through the PlotDec16 or CompTo 16 components) then the data form is short. If the data is being stored in 8-bit resolution (usually when passed through the CompTo8 component) then the data form is Byte. If the data is in 32-bit integer format, the data form is Integer.

Dec_Factor is the decimation factor when the streaming data is being decimated. When decimation is not required, the value should be set to 1.

If a PlotDec16 component is being used for decimation, then the **Dec_Factor** will be half of **nDec** on the PlotDec16. If a CompTo16 is being used, then the **Dec_Factor** should be set to 1.

Channels is the number of channels of snippets being recorded.

Uses: Each compiled circuit file assigned to a device, in OpenWorkbench, that will be used to acquire continuous data must include this construct.

Description: Data streams are continuously acquired and stored waveforms that do not require a unique time stamp. Because the event is streamed and all values are stored, TTank can keep account of the precise time when each streamed event was stored.

Typical streamed events include slow wave brain recordings, decimated multi-channel extracellular recordings, and any event that requires a chart recording of all or most of the data.

Details: Each data buffer must include parameter tags using the tag root with the following prefixes and suffixes:

s prefix for the sync parameter

Only one parameter tag with the s prefix is required because all streams are acquired at the same time and are the same

size and position.

- d prefix for the data tags that are stored

This tag may also include a suffix with a tilde and a number if there are multiple acquisition channels. For example, dPD~1 and dPD~2 would be used for two channels of data associated with the data stream using the tag root PD. Before the circuit is stored as an compiled circuit file, the number of channels is checked by comparing the tilde values to the oxStream buffer value.

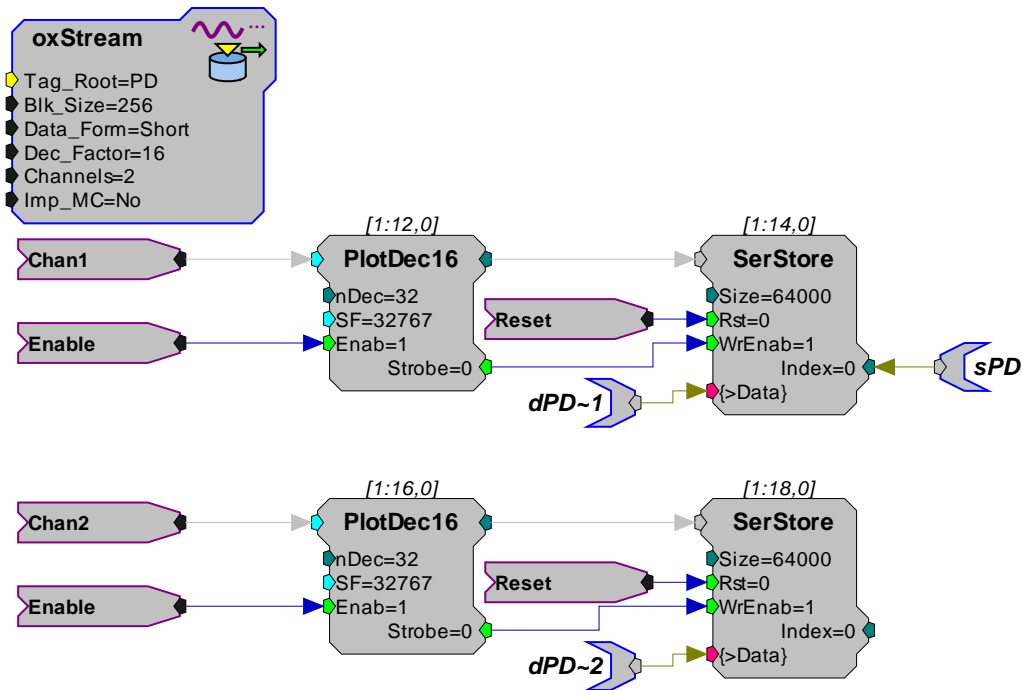

In this example, 2 channels of data stream are associated with the oxStream component through the use of the tag root PD. The tag root is set in the oxStream component and could be changed to any value.

The Chan1 and Chan2 lines are data from an acquired signal. The Enable line from the zTrigB starts the plot decimation component (PlotDec16).

The PlotDec16 finds the maximum and minimum value from a set of 32 points and then stores the data as two 16-bit integers in a 32-bit word for later decompression. Every 32 samples a strobe signal is sent to the SerStore component to store the data. (Note that the size parameter of the SerStore components should always be an even multiple of the block size defined in the OxStream component.) While the protocol is running, OpenWorkbench polls the Store to see if the block size has increased by 256 points. Once it has, the data is stored as 512 floating point values.

Note that there is only one sPD since both Stores will download the same number of points.

Secondary Tag Constructs

Several constructs exist for implementing secondary tags in OpenEx without the aid of macros. See Secondary Tags, page 69 for more information about secondary tags.

Secondary tag constructs can be used to implement secondary tags when using non-macro data storage.

The secondary tag construct is implemented by first selecting a data construct component for the primary store. Additional secondary Stores can be made into secondary tags, which do not require circuit headers and only need constructs for saving the data.

There are three common constructs used with secondary tags:

A Latch component can be used for asynchronous scalar values.

A MultiLatch component can be used for multiple asynchronous scalar values.

A SerStore component can be used for lists and data buffers.

Latch

Uses: Each compiled circuit file that will be used to acquire asynchronous scalar values from a single secondary tag must include a latch construct.

Description: This construct provides a way to store one secondary tag value latched to data tags in the primary triggered scalar construct.

Details: The latch component stores a value when a trigger pulse is sent high then low. Each trigger event will store a new value. The latch is not reset once read (that is, set to zero).

Using a Latch to store a scalar value as a secondary tag:

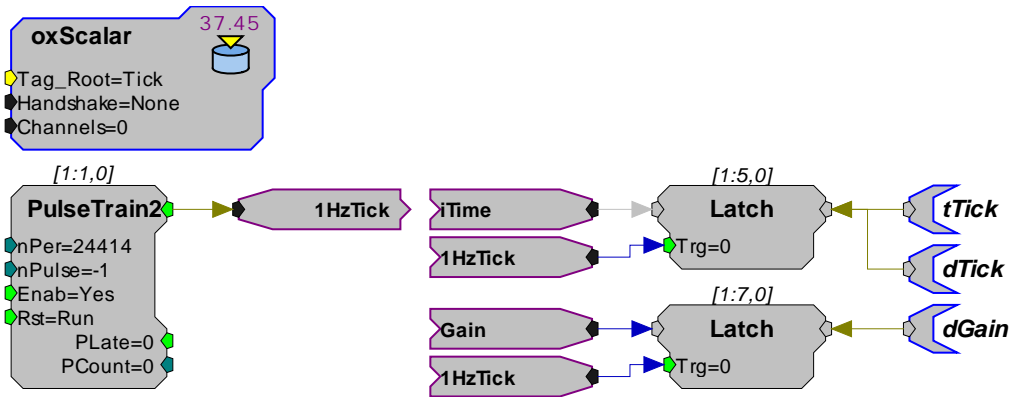

In the above circuit, two scalar values are stored – Tick and Gain. Tick is the primary Store, so it includes an oxScalar circuit header and tags for the data (dTick) and time stamp (tTick). Gain is the secondary Store. It only requires a latched value for the data.

The data is called dGain here for consistency, but any name could be used. Notice that the data values for both Stores are latched at the same time (by the 1HzTick pulse) – this is essential for secondary tags to work correctly.

To store Gain, no circuit header is required and no time stamp tag is required. Simply add dGain as a secondary tag of Tick in the OpenWorkbench Stores settings. Then the gain will be stored and it will automatically use the time stamps of Tick.

MultiLatch

- Uses:** Each compiled circuit file that will be used to acquire asynchronous scalar values from multiple secondary tags must include latch or multilatch construct(s).
- Description:** This construct provides a way to store secondary tag values latched to data tags in the primary triggered scalar construct.
- Details:** The MultiLatch component stores parameter values from the PC until triggered. An input line is used to trigger the MultiLatch component. When triggered it sends the new values to output lines.
- This ensures that signal parameters are updated after the stimulus has been presented. The latch also updates the data parameter tags. When the software polls the variables it will detect the updated values and store them.

Using a MultiLatch to store multiple scalar values as secondary tags:

More than one secondary tag can be latched to a triggered scalar data construct by adding multiple Latch components with tags for saving the data of the additional scalar values. The number of components can be reduced by using a MultiLatch component to latch three values at once:

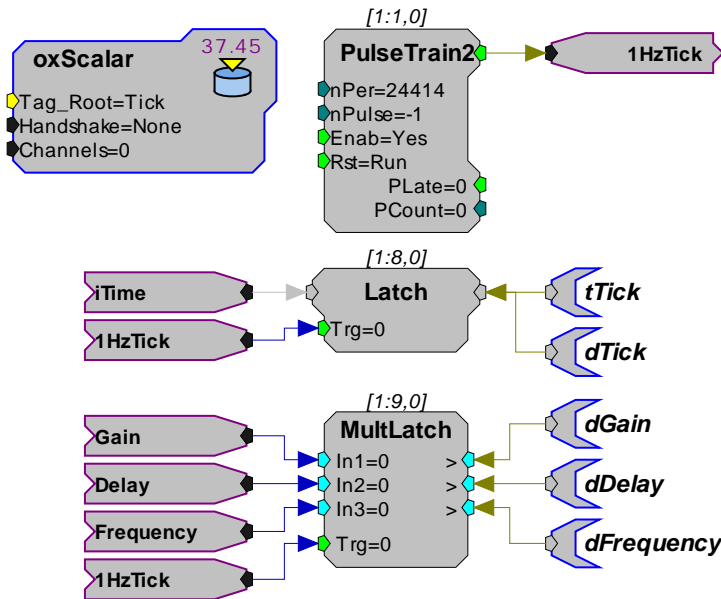

In this circuit, Tick is the primary Store and three secondary tags are stored – dGain, dDelay, and dFrequency.

All of the values are latched at the same time as Tick, so they can all share the same time stamp values. Each of the three must be added as secondary tags of Tick in the OpenWorkbench Stores settings.

Serial Store

Uses: Each compiled circuit file that will be used to acquire list or buffered data from secondary tags must include a serial store construct.

Description: A serial store can store buffered data. When used for a secondary tag two or more buffers can be acquired using the same time stamps.

Using a SerStore to store a data list as a secondary tag:

Storing a data list as a secondary tag involves the same basic process as storing scalar values as secondary tags.

First, the primary Store must be created, the secondary Store is then created by making only the data portion of the Store with no time stamps or circuit header. Finally, the secondary tag is added to the OpenWorkbench Stores settings of the primary Store. The difference with data lists is that the data is a memory buffer rather than a single scalar value.

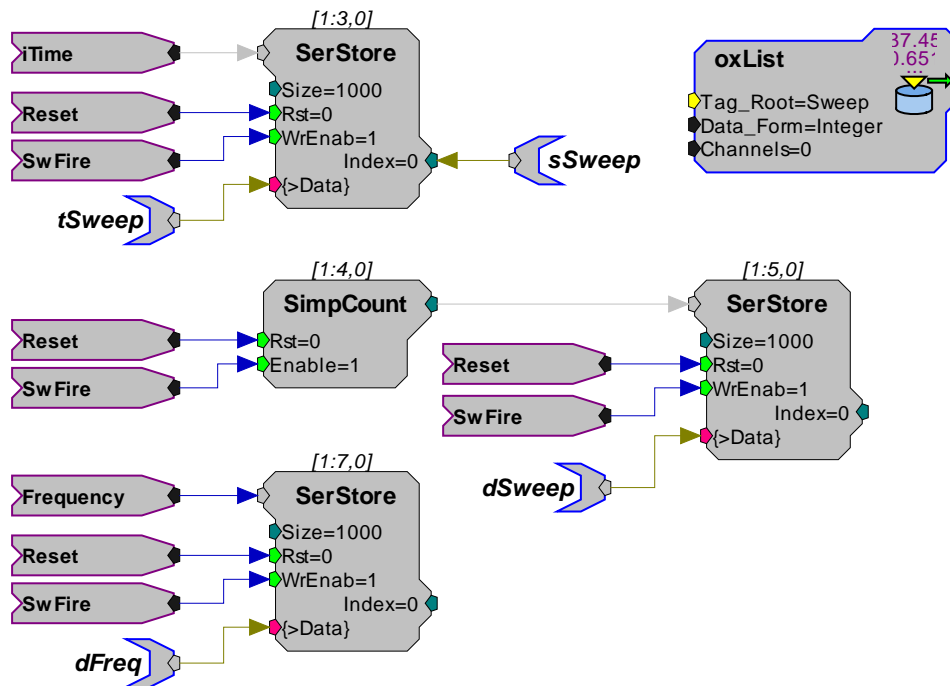

In this circuit, Sweep is the primary Store. It includes an oxList circuit header and buffers (SerStore) for storing its data (dSweep) and time stamps (tSweep). The sync parameter (sSweep) is also necessary for the data list. Freq is the secondary Store. It only requires a buffer for the data. The data is called dFreq here for consistency, but any name could be used. No circuit header, time stamps, or sync tag are required for the secondary Store.

The essential part is that the values of Freq are stored at exactly the same time as the values of Sweep. All of the SerStores have the SwFire hop connected to their write-enable port. So every time a sweep fires, each buffer will store a single value. Simply add dFreq as a secondary tag of Sweep in the OpenWorkbench Stores settings.

Instantaneous Rate Construct

About Instantaneous Spike Rates

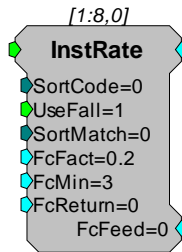

The InstRate component is particularly useful for OpenEx users acquiring extracellular spike data.

The InstRate continuously measures the spike activity from an electrode channel or group of sorted spikes. The spike rate is calculated by integrating the spike activity over time. A low pass filter is used to integrate the spike rate and also acts to interpolate the spike rate between spike events. For a more complete description of the InstRate component see the RpvdsEx help.

When to Use the Instantaneous Rate

The InstRate allows end users to visualize changes in spike activity in response to stimuli and may be the primary information saved to the data tank or disk. InstRate can also be used anytime a real-time measure of the spike activity is required, such as when the spike rate is used to control external devices, gauge the quality of a signal, or examine spike activity in real-time.

How to Store/View the Data

Instantaneous rate data can be stored in one of two formats, either as a list value that occurs at discrete epochs in the acquisition system or as a continuous decimated stream. Either data format can be viewed in real-time through OpenController using an appropriate visualization tool.

InstRate Construct

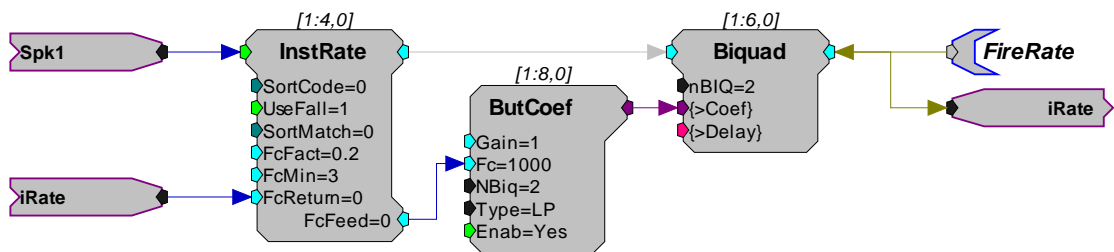

The minimum components necessary to use the InstRate include the InstRate, the ButCoef, and the Biquad. The ButCoef, Butterworth Coefficient generator, controls the lowpass filter frequency while the Biquad uses the coefficients to generate the digital filter. The circuit construct below shows a more typical construct which includes a SerStore to store the spike rate to the data tank.

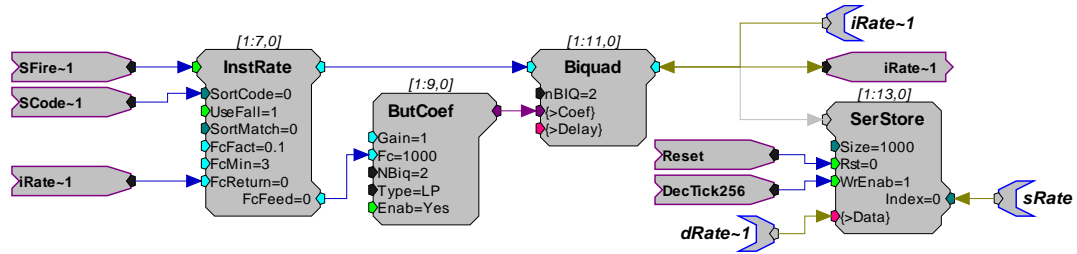

The primary input to the InstRate is the strobe out from the spike component (Sfire~ HopIn). This example also includes sort code input to the SortCode parameter from the SortBits output of the spike component (Scode~). The sort code to match can be set in the InstRate SortMatch parameter. A parameter tag (FcFact) has been included to allow the user to set the maximum rate of change of the filter from OpenController.

The primary output is fed through the filter that is constantly updated using a loop from the InstRate's FcFeed to the FcReturn. The FcFeed is fed to the ButCoef corner frequency setting to update the corner frequency of the filter. The output from the filter is saved to a Store and is also fed back into the FcReturn. The FcReturn value is used to calculate a new value for the FcFeed.

Notice that the SerStore stores the new rate once every X number of sample ticks. In general the InstRate will not exceed a rate of, at most, 250 events per second. This means that recording the spike rate continuously would be inefficient. A decimation rate of between 128 and 256 is recommended, depending on the maximum firing rate of the neurons.

OpenController Constructs

Biquad Filtering

When necessary, filters can also be implemented without macros. A biquad filtering circuit construct is required for each biquad filter that will be implemented through OpenController.

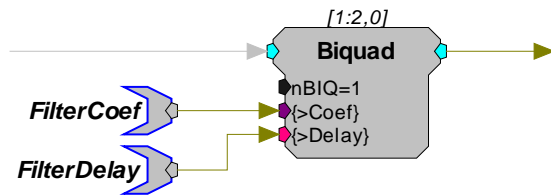

In this example:

The **FilterCoef** parameter tag is used by OpenController to load the coefficient values for that filter setting to the Biquad.

The **FilterDelay** parameter tag is used to reset the Biquad delay lines. If the delay lines are not zeroed it is possible for the filters to crash.

These parameter tag names are suggested names. The parameter tags must be defined as the Coef Target and Delay Line Target in a control's property settings.

SigGen Control

The following circuit construct must be added to the RPvdsEx circuit to allow users to load and control SigGen generated stimulus through OpenController's SigGen Engine Control.

In most cases the SigGen file will be used with a sweep based stimulus protocol. The information below assumes that the circuit construct is part of a circuit that includes a sweep or condition construct and that the construct is controlled by an OpenWorkbench protocol that uses sweep settings. It is possible to use SigGen circuits in other circuits and OpenWorkbench protocols, however, the circuit control must be designed by the end user.

SigGen Signals are generated on the PC and then loaded to and played from the SerSource component.

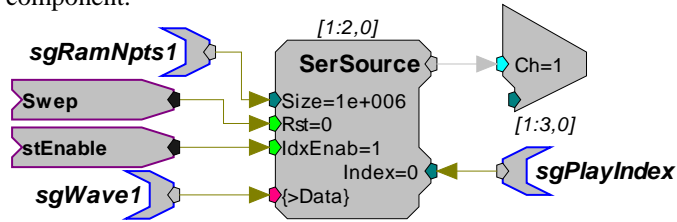

sgRamNpts1 parameter tag determines the size of the buffer.

sgWave1 parameter tag loads the SigGen file to the SerSource component.

Sweep resets the buffer before the start of the next stimulus. (This should be changed to condition if condition control settings are used rather than sweep control settings in the OpenWorkbench protocol.)

stEnable plays out the signal from a sweep based protocol. (This should be changed to CoEnable if condition control settings are used rather than sweep control settings in the OpenWorkbench protocol.)

Appendix B – Tips, Tricks, and Technical Information

In the Tips, Tricks, and Technical Information section you will find:

Quick access to topics of special interest to OpenEx users. If you are looking for shortcuts and tips for working in the OpenEx environment, you'll find our *Tips, Tricks, and Technical Information* area to be a useful resource.

Connecting the Hardware

The OpenEx Software Suite may be used with any of the System 3 real-time processors. Some of the most common hardware configurations are described below.

See the installation guide supplied with your system for more information on connecting your hardware.

Connecting a Multi-Channel Pentusa System with Multiple Medusa Preampifiers

The diagram below shows a typical 32 channel system with a single Pentusa base station, two preamplifiers, and Gigabit interface.

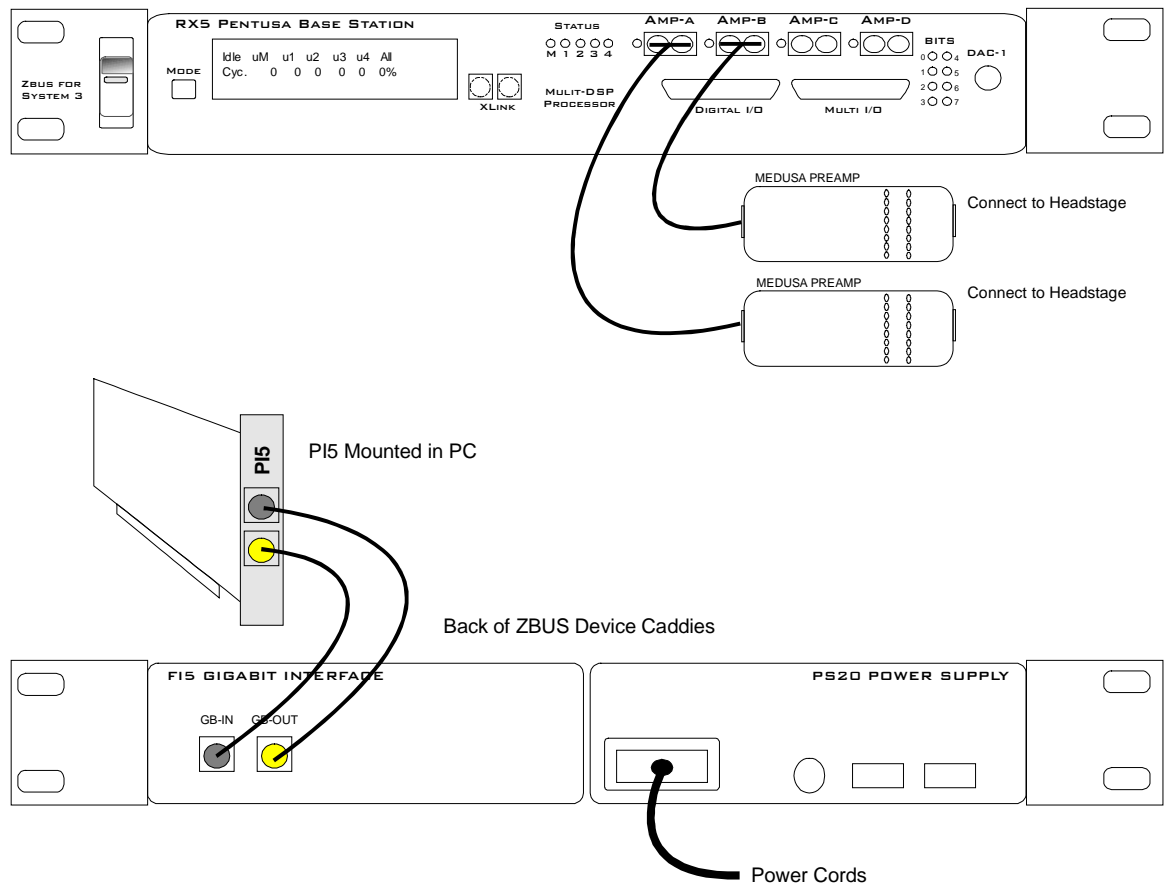

Connecting a Medusa System with a Single Medusa Base Station

The diagram below shows a typical Medusa Amplifier and Gigabit interface system for less than 16 channels.

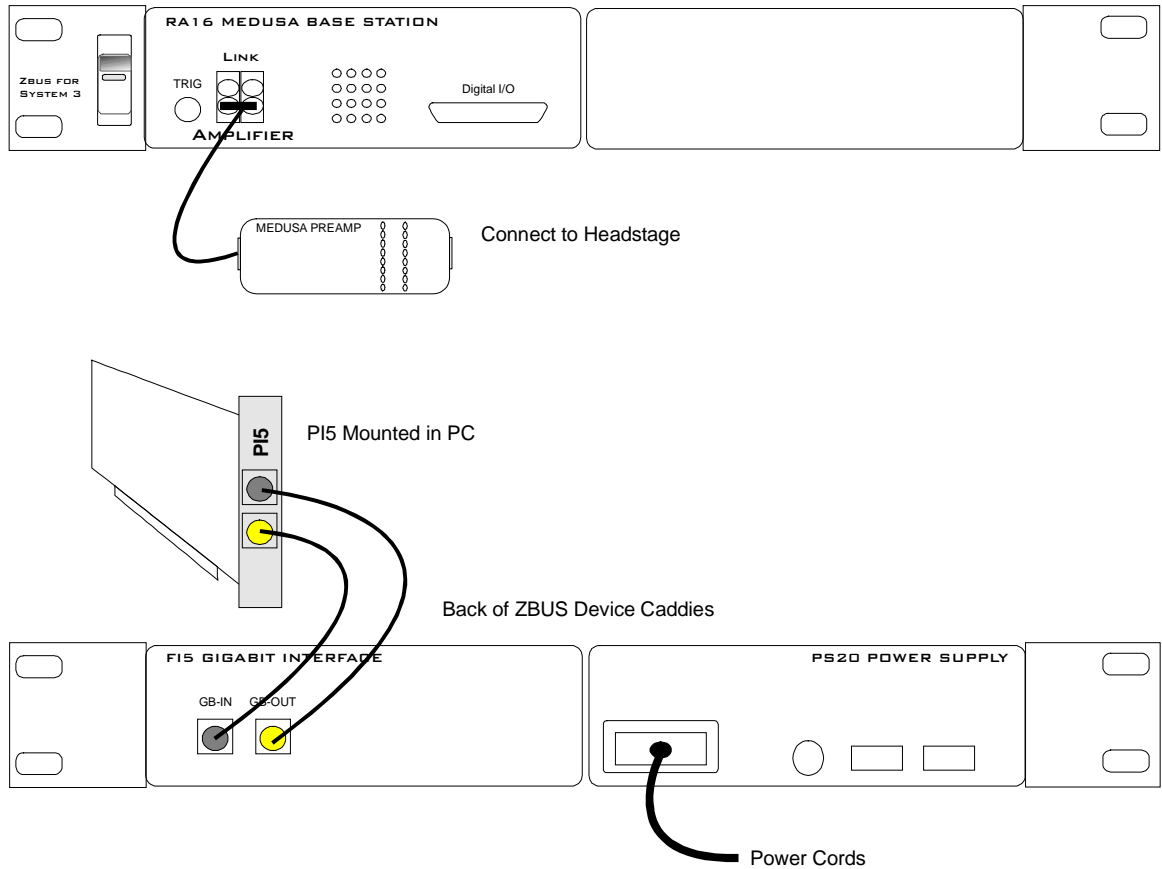

Notes:

PI5/FI5 Gigabit interface: provides communication between the PC and the zBUS as well as between zBUSs.

ZB1PS zBUS: provides communication and power for modules mounted in the device caddie.

RA16 Medusa/ RX5 Pentusa Base Stations: provide onboard processing and a fiber optic link to preamplifiers and headstages. Multiple Base Stations are linked for higher channel count acquisition.

Tips for Working in OpenEx

OpenWorkbench Idle Mode

Use caution when switching to OpenWorkbench's Idle mode. In Idle mode many values set from OpenController are cleared from the hardware. Use Standby mode, rather than Idle, to pause an experiment.

Compiled Circuit File Sampling Rates

Compiled circuit files are interchangeable among devices, but keep in mind that not all devices will run all sampling rates. For example, a high frequency auditory stimulus file designed for playback on an RP2 may not be suitable for playback on an RA16BA which has a maximum D/A sampling rate of 48 kHz.

Tips for Modifying Circuits

Because the RPvdsEx system is complex, simple acts can cause circuits to fail. Included below are several tips to help users avoid common mistakes that might occur when modifying RPvdsEx circuits for use with OpenEx.

- One of the most common problems that users encounter is exceeding the maximum cycle usage. The problem can easily go unnoticed because the cycle usage displayed in RPvdsEx and OpenEx will wrap around if it exceeds 100%, for example, if a large circuit appears to be running a only 10% cycle usage, it has probably wrapped around and is really using 110%. See the RPvdsEx help for information on reducing cycle usage.
- Always recompile the circuit after making changes. The circuit is automatically recompiled on saving when using the .rcx format.

The common problems below can be avoided by using macros wherever possible within the circuit. Using macros in your circuit design automatically handles required constructs, reserved OpenEx parameter tags, parameter tag naming conventions, component parameter dependencies and OpenEx header settings.

- When deleting parts of a circuit, be careful to avoid deleting control and timing constructs or reserved OpenEx parameter tags. Deleting these components from the circuit will cause OpenEx to be unable to control the circuit properly.
- When using OxStream to read data from the hardware the Dec_Factor must be a multiple of the Blk_Size, otherwise you'll read a partial block back. When this happens you'll see data coming back as if all where fine but that data will be erroneous.
- Always follow the OpenEx naming conventions for parameter tags. Be aware of reserved tags and tag prefixes, especially when adding a data construct (Store). If the correct reserved tags and prefixes are not used, then OpenEx might not be able to control the circuit or store data correctly.
- After changing a value related to a Store in the circuit (for example, changing the block size of an OxStream), any OpenController controls that use the corresponding Store as a target will not work properly. Double-click on each of these controls and re-select the Store as the Data Target, and then they will work again.

OpenEx Cheat Sheet

The cheat sheet provides a quick reference to some of the shortcuts and non-menu driven features of the OpenEx applications. Click an application below to see the quick list for that application.

OpenController

- Press and hold down the Shift key and drag the mouse up or down (or right or left) to adjust the scale of a plot control.
- Double-click a control to display its properties dialog box.
- To display the properties dialog box for the Controller window, double-click the grid area (Design mode). The dialog includes parameters for behaviors such as Auto Run and Lock on Stop.
- Right-click the scrolling threshold or snippet sort controls to display the auto sorting and auto thresholding commands.

Snippet Sort Control:

- Adjust the scale of the Snippet Sort plot (as described above) to show threshold markers that are not positioned in the plot's visible area.
- Hold down the control key and double-click in the center of the control to add a time-voltage window bar.
- Point to the center of a time-voltage window bar then drag it into position.
- Point to the end of a time-voltage window bar and drag to resize the bar as needed.
- You can add multiple time-voltage windows. To remove a time-voltage bar, drag it off the edge of the plot.

OpenScope

- Press and hold down the Shift key and drag the mouse up or down (or right and left) to adjust the scale of a plot.
- Double-click a plot to display its properties dialog box.
- Click a tank, block, and event in the Tank Navigator to select data for plots. Data must be selected in the Tank Select window before you can create or animate a plot. Because tracking always uses the current data, you can animate the plot in track mode without first selecting the data.
- Drag an event to the grid area to create a plot.
- Add an event to the timeline by dragging it from the Events list to the Time Control window.
- Look for the  Epoch icon to identify epoch events. Epochs are defined in OpenWorkbench and used in OpenScope and OpenBrowser to organize and display data. Epochs are stored events that are associated with a block's timeline.

Open Browser

- Select a row before adding an Tref epoch. To add the epoch, right-click the next available cell in the header row (row 4) and select an event from the available epoch events.

Using these shorthand characters to configure additional rows once the first row has been configured in Data Selection Table:

^	Indicates that the value in the cell above will be used for this cell. For example, placing a caret in a cell in the TANK column will cause the row to acquire data from the tank named in the row above.
^+	Used with BLOCK, CHAN, and SORT cells. It will increment the BLOCK, CHAN, or SORT number by one, relative to the cell above it.
>	Used with TIME, CHAN, SORT, and epoch cells. Channels that are greater than the cell value are viewed and exported. For example, >3 selects channel or sort values greater than 3.
<	Used with TIME, CHAN, SORT, and epoch cells. Values that are less than the cell value are viewed and exported.
:	Used with TIME, CHAN, SORT, and epoch cells. Values within the named range are viewed and exported. For example, if a cell in the CHAN column contained the statement 3:10 then channels 3 through 10 would be viewed and exported.

OpenWorkbench

- Click a device icon in the Device Navigator to display the device configuration in the main window.

Clean Running Applications

If a user attempts to run OpenProject when an OpenWorkbench or OpenProject application is already running a Clean Running Applications applet will be launched. This applet lists running project applications and allows users to choose between terminating the applications or quitting the project start up processes. Note: Applications other than OpenWorkbench that were not loaded with OpenProject will not appear in the list.

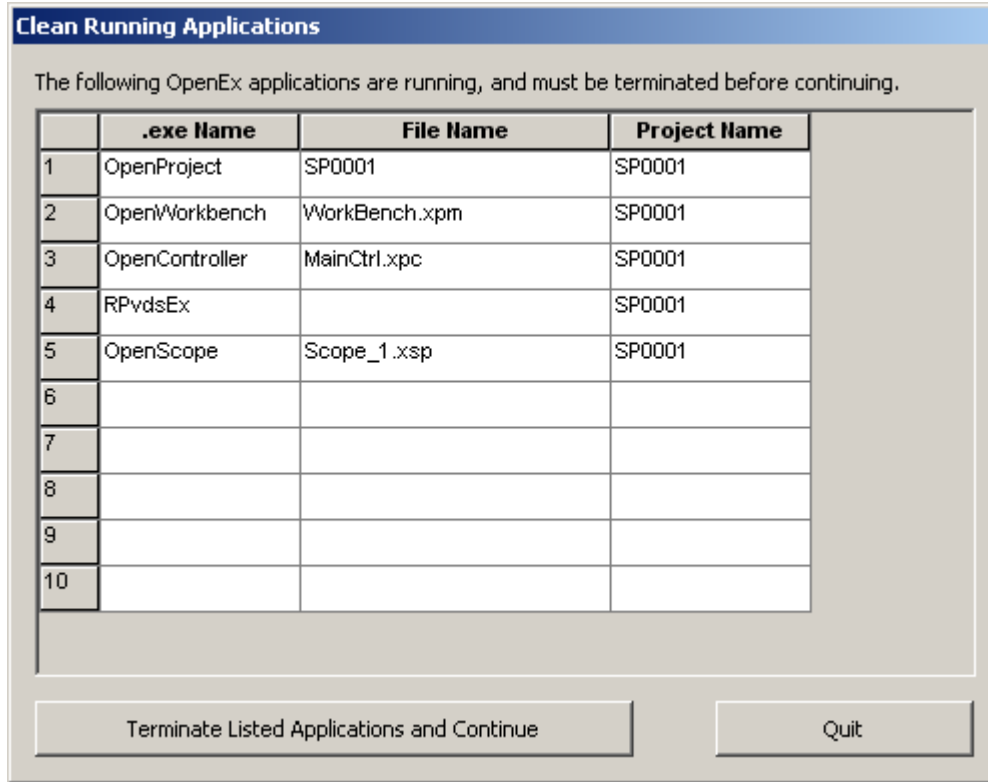

Terminate Listed Applications and Continue: terminates all applications listed

Quit: halts the project creation process, closes the Clean Running Applications window, and allows the current OpenEx applications to continue running.

The applet is launched in the following four conditions:

- OpenWorkbench is running and OpenProject attempts to run. Choose either to terminate or quit.
- OpenProject is running and a new OpenProject attempts to run. Choose either to terminate or quit.
- OpenProject or OpenWorkbench fail to close properly (such as when an application quits unexpectedly) and a new OpenProject attempts to run. Choose to terminate.
- Immediately after Installation of OpenEx. This occurs because the applications are being registered and that process has not been completed. Choose to quit so that the registration process can continue. The applications will exit on their own.

Note: The Clean Running Applications applet does not load if users attempt to run OpenWorkbench while OpenProject or another OpenWorkbench file is running. OpenWorkbench will not open and a message is displayed indicating that another instance of OpenWorkbench is running.

Optimizing Performance for High Data Transfer Rate Operation

When operating OpenEx at higher data rates (generally 16 channels or more) measures should be taken to improve overall system performance and efficiency. The system is optimized via modifications to the OpenEx project and its Stores and by terminating unnecessary applications running on the host PC.

The following list of guidelines can be used to optimize system performance.

OpenEx:

1. In OpenWorkbench, set the '**Cache Delay**' preference to **6.0** seconds and ensure the '**Flush read when overload**' preference is NOT enabled. To check or modify these values, click **File | Preferences** in the OpenWorkbench window.
2. Turn off all unnecessary scrolling plots within Workbench. To turn off individual, right-click the plot and click **Hide**.
3. Run each device or compiled circuit file in your OpenEx project at the lowest acceptable overall sample clock rate. For example, if you're collecting EEG type signals you should set the device sample rate to no more than 6 kHz.
4. Ensure a reasonable sample rate is being used for each Store in your project and use 16 or even 8 bit data for Stores whenever possible.
5. Remove any redundant data Stores. For example, if you are storing the full 25 kHz bandwidth signals in your single unit collection project, there is no need to also store a band-limited LFP version of these sample signals.

Operating System:

6. Turn off unnecessary applications including:
 - a. Background applications like anti-virus, firewall and spyware detection tools
 - b. Services that run in the background even if you do not have the program open.
7. Turn off any automatic update features.
8. Avoid launching applications once data collection has started in OpenEx.
9. Avoid doing other tasks on the collection computer while it's running OpenEx (like accessing the Internet).
10. If you have USB or the Wired Gigabit interface, consider upgrading to the Optical Gigabit Interface.

If you need assistance with any of the above design guidelines, please contact TDT technical support.

Working with Long Blocks

In OpenEx, the data acquired during each recording session is typically labeled and stored to the tank as a single OpenEx Block. Theoretically, there is no limit on the size of a single block or

tank; however, we recommend that neither exceeds a size of 2GB to ensure the best performance possible. Lengthy recording session can be divided into several smaller blocks, depending on the amount of data being acquired. Users who frequently run lengthy recording sessions, but do not want to divide the data into several OpenEx Blocks, can still limit the amount of data being acquired. One way to do this, when acquiring spike data, is to “pause” active event acquisition without actually pausing the recording session.

The technique described here might be suitable for experiments in which there is a lengthy delay between delivering a stimulus and some response of interest. It allows the user to record selected periods of interest in a single block. This is especially helpful when each OpenEx block will be individually processed offline. Reducing the number of blocks reduces time spent in demanding offline processing.

Pausing Event Acquisition Without Closing the Block

The circuit segment below shows how the user can create such a pause using the threshold (Thresh) parameter of a SortSpike2 component. This technique will also work with the threshold (ThLo) parameter of a SortSpike component.

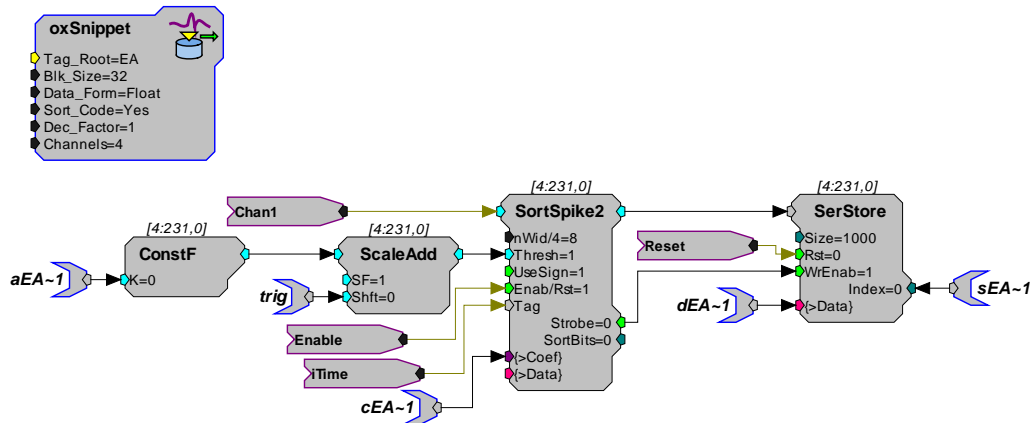

Usually the aEA~1 tag is linked directly to the threshold parameter. In this case, a ConstF and ScaleAdd have been added between the aEA~1 tag and the parameter port. The ConstF is included to convert the parameter tag output to a signal that can be used by the ScaleAdd. The addition of the ScaleAdd provides a simple means of altering the signal value. When the scale factor (SF) is set to 1, via the trig parameter, the threshold value passes through without being altered. However, if the scale factor is set to 0 the threshold value will also become 0. When the threshold value on a SortSpike 2 (Thres) or SortSpike (ThLo) becomes 0, no spikes are acquired. This creates the desired pause effect without stopping the recording session.

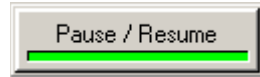

The value of this trig tag (which controls the scale factor) can be set from OpenController using a simple switch control. The switch, with an on value of 1 and an off value of 0, can be used to pause and resume event acquisition within a single block.

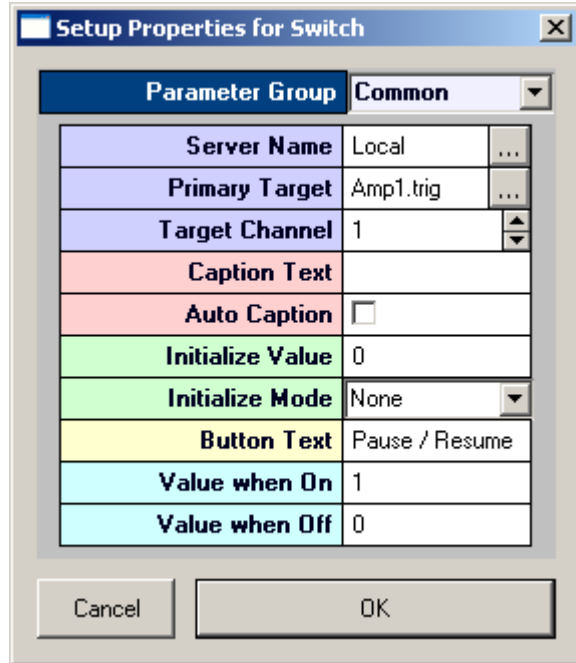

FAQs

In this topic you'll find page references to areas of the help that will provide answers to some of the most frequently asked questions about OpenEx. Some of these questions refer to advanced topics and may require a bit of background reading so be sure to view any supporting information regarding these topics.

How do I choose a Data Construct?

Choosing a Data Construct, page 66.

How do I choose a Spike Component?

Choosing a Spike Component, page 71.

How do I calculate the data transfer rate?

Calculating Data Transfer Rates, page 67.

How can I view the firing rate on an acquisition channel?

About Instantaneous Spike Rates, page 346.

What are epochs?

About Epoch Events, page 81.

Known Anomalies

Note: The latest anomalies and tech notes are always available on the Web at www.tdt.com/T2Support/FlashHelp/System3TechNotes.htm.

When operating OpenEx at higher data rates (generally 16 channels or more) measures should be taken to improve overall system performance and efficiency. The system is optimized via modifications to the OpenEx project and its Stores and by terminating unnecessary applications running on the host PC.

The RZ2 does not support sample clock edge synchronization. In the OpenWorkbench Preferences dialog box, the *Synchronize sampling clocks* check box is not checked when using the RZ2.

Errors may be generated when attempting to filter blocks larger than 2GB. See tech note 0222 to resolve this problem.

A partial install or partial uninstall of OpenEx may not be able to be uninstalled automatically. In this situation, a manual uninstall may be necessary.

When a control circuit is not located in the project's local RCOCircuits directory and the user has to browse outside the local directory, a local copy is created within the project's RCOCircuits folder (this local copy behavior is controlled by a preference within OpenProject). In version 2.0, the control circuit file path seems correct and a local copy is generated, however, the project is still pointing to and using the original browsed version of the circuit. Therefore, changes made to the local copy of the circuit have no effect.

A channel of streamed data might fail to be stored when acquiring data using OpenEx. The probability of this occurring is very low. It has been observed only for continuous data and only when using mirror devices. However, there is no guarantee that the problem is restricted to these conditions. We recommend avoiding putting **OpenWorkbench** in Idle mode until the end of the experiment. Instead, use Standby mode when acquisition must be stopped. (First noted in 1.57)

An error message, such as "unable to connect to specified device" might be generated when **OpenWorkbench** attempts to reset multiprocessor devices (RX5, RX6, RX7, RX8). To avoid this issue, change OpenWorkbench preferences so that hardware is not automatically reset on launch. See Tech Note 0156 for more information. (First noted in 1.57)

Values in the **OpenController** Data Table are displayed with a precision of 1. However, the actual value is retained. For example: a value of 0.0001 is displayed as 0.0, but 1.0001 will be passed to the target.

OpenController crashes and an error appears stating, "MainCtrl caused an exception and has been closed" when a percent sign is used in a graphic frame.

If the Windows Script Debugger has not been installed, loading any **OpenController** files that include VBScript components causes the OpenController to crash. Install the latest version of Windows Script Debugger. It can be downloaded from this URL:

<http://www.microsoft.com/downloads/details.aspx?FamilyID=2f465be0-94fd-4569-b3c4-dffdf19ccd99&displaylang=en>

Note that Windows XP and Windows 2000 do not come with the Windows Script Debugger installed, so this will need to be installed when using OpenEx with VBScript. (First noted in 1.0.)

After adding a new control from the **OpenController** Controls menu, international users are unable to modify the Value properties for a Slider, or any control that uses the Value property sheet. To avoid this problem, international users should open the Regional Options in the Windows Control Panel and change the following settings on the Numbers tab. Change the Decimal Symbol to a period. Change the Digit Grouping Symbol to a comma. (Found in all versions.)

On some systems, the Windows Installer launches erroneously, asking the user to insert the Microsoft Office 2000 CD-ROM. The action must be canceled several times before normal operation can continue. This problem has been seen when starting **OpenWorkbench** and when setting the Server of a control in **OpenController**. (First noted in 1.1.)

Chart plots in **OpenController** and **OpenScope** can only be used with scalar or snippet data. Using stream or buffer data may cause OpenController/OpenScope to crash or display data improperly. (First noted in 1.1.)

If epoch events occur infrequently the event might be missed by OpenEx polling and, as a result, the Store will not appear in the **OpenScope** or **Open Browser** timelines or events list. The data is acquired and can be accessed by manually typing in the event name in Scope or Browser. For more information see Tech Note 0116.

Offset Strobe epochs events that exist in the tank data, do not automatically appear in the **OpenScope** timeline. You can add the event to the timeline manually by dragging it from the Event list to the timeline. (First noted in 1.1.)

When using oxBuffers or oxSnippets with large block sizes (greater than 5000), some blocks do not appear in **OpenScope** and **OpenBrowser**. However, data is stored in the tank and can be exported. Smaller block sizes should be used whenever possible. (First noted in 1.0.)

Error message "Trouble saving data to tank" is displayed if no data has been saved to tank for an extended period of time (approximately ten seconds). To avoid this problem a Pulse Train can be used to generate a pulse to be stored once per second. (First noted in 1.0.)

You can only have 100 tanks registered in TankMon at one time. Removing a tank from the monitor does not delete it, however in version 1.57 and below, tanks cannot be used when they are not registered.

Users can not register or unregister tanks without administrator privileges.

When deleting blocks from a tank in **OpenBrowser**, the deletions are not saved.

'Unable to open tank...Tank does not exist' error message is displayed when attempting to open a tank with a name 32 characters long or longer or a path name 100 characters long or longer.

When trying to delete a large block in OpenScope using the Tank Select window, a server busy error will appear.

OpenEx 2.0 uses a new data tank structure that is not supported by Windows 2000 or earlier operating systems. The new version allows users to manage tanks and individual block using Windows Explorer.

If **OpenWorkbench** detects more than one Store by the same name a duplicate store error -- "multiple stores have the same name" -- is reported and OpenWorkbench will not run until the duplicate store's name has been changed or the duplicate store has been disabled. See tech note # 0271.

Resolved Anomalies

Version 1.57

After WindowsXP Service Pack 2 or Windows Server 2003 Service Pack 1 is installed, OpenController can no longer access OpenWorkbench. New security settings, included in these service packs, affect the performance of client/server applications. See Tech Note 0134 (Windows Service Pack 2) or Tech Note 0175 (Windows Server 2003 Service Pack 1) for step-by-step instructions for using this service pack with OpenEx. **Fixed in version 2.0**

Error message "Cannot add tank. No error to report." or "Cannot delete tank. No error to report." is displayed when attempting to add or delete tanks from OpenWorkbench if the user does not have administrator privileges. **Functionality changed in version 2.0**

Version 1.5 and 1.52

The Threshold Scaling Factor in **OpenController's** Scrolling Threshold Control may spontaneously reset to 0. This occurs whenever settings in the Behavior parameter group are modified, or even viewed, in the Setup Parameters dialog box. Avoid opening the Behavior parameter group. Most behavior parameters that users will need to modify can be modified in the Common parameter group. **Fixed in version 1.54.**

The signal in **OpenController's** Snippet Sort Controls might disappear unexpectedly. The green threshold marker will be set to the 0 position. Attempting to move the marker will cause it to disappear. This occurs because the Y-Axis Units Factor has reset to 0. This can occur spontaneously whenever the Y-Axis Setup parameter groups is modified, or even viewed, in the Setup Parameters dialog box. Avoid opening the Y-Axis Setup parameter group in the Snippet Sort Control. Parameters in other parameter groups can be modified without problems. **Fixed in version 1.54.**

Version 1.1

Recording to multiple tanks at the same time causes Tank Server errors. The protocol appears to run without data loss initially but Tank Server errors are generated repeatedly after the protocol is stopped. **Fixed in version 1.5.**

In OpenScope, the XY plot does not display the first plotted point. **Fixed in version 1.5.**

OpenWorkbench will always use the sample rate defined in the compiled circuit file (.rco), even if the "Use sample rate from RCO file." box on the Devices property sheet is cleared. Each time you need to run a circuit at a different sample rate, change the sample rate in the circuit file (.rpd) then recompile the RPvdsEx file (.rco). **Fixed in version 1.5.**

Currently only one SigGen Engine control can be used in each instance of OpenController. A second one cannot be added even if the existing control is deleted. If a SigGen Engine control is deleted, restart OpenController before attempting to add a new SigGen Engine control. Restarting should allow you to add a single SigGen Engine control. **The limitation of one SigGen Engine control per Controller remains but the anomaly associated with adding and deleting the controls has been fixed in version 1.5.**

If a tank name contains spaces, or if the directory path to a tank contains spaces, then the tank may be named improperly, appear in a different location, or fail to function correctly. **Fixed in version 1.5.**

Version 1.0

Error message “Cannot Close there are active COM clients. Must close all instances of Open Controller” is displayed when closing **OpenWorkbench**. In this version OpenWorkbench launches applications correctly, but can not close all Controllers, so the user must close Controllers manually before closing OpenWorkbench. **Fixed in version 1.5.**

In OpenScope, Invalid property value error 380 appears when starting OpenScope if the font size (DPI Setting) is set too large in Windows Display properties. Setting the display font size (DPI setting) to small fixes the problem. **Fixed in version 1.1**

OpenBrowser is unable to export all events if the time between two successive events is too great. Until this issue is resolved make sure that events occur at regular intervals. **Fixed in version 1.5.**

Troubleshooting

Below is a listing of general issues you may encounter in OpenEx. If you encounter an error that is not described below, contact tech support at support@tdt.com or consult the online tech notes database at: <http://www.tdt.com/support.htm>.

Access to path and application was denied

Occurs when attempting to run an OpenEx project using the Windows XP or Windows 2000 operating system without administrator privileges.

OpenEx modifies the registry on your Local Machine (that is, the PC on which you run the application). Windows requires that users have administrator level privileges to modify the Local Machine registry.

Multiple stores have the same name

Occurs whenever OpenWorkbench detects more than one Store with the same name.

Make sure all store names are unique either by renaming the circuit components in RPvdsEx or by disabling the duplicate store in OpenWorkbench.

Note that duplicate buddy epocs are harder to detect since the default setting in OpenWorkbench does not show buddy Epocs. To disable a buddy Epoc Store, select **Show All Fields** from the Storage Specification dialog box. This will display all stores and allow all stores to be disabled. Set the **Mode** of the Store to **Disable**.

RZ device fails to run a circuit in OpenWorkbench

Occurs when the *Synchronize sampling clocks* check box is checked when using the RZ2 or RZ5.

The RZ devices do not support sample clock synchronization, a project will fail to run if this option is selected in OpenWorkbench. Uncheck the *Synchronize sampling clocks* check box in the OpenWorkbench Preferences dialog box to run the circuit.

Tank or zTime errors are generated when switching between Preview and Record mode in OpenEx.

When OpenEx changes from Preview mode to Record mode or visa-versa the circuit is not halted. During this switch it is possible that some components might not be reset to the proper state (i.e. timing components or store related components such as a buffer write enable). This will cause Tank or zTime errors.

Switch to Idle Mode before switching from Preview to Record mode.

Memory allocation failure

Occurs when attempting to set the number of channels or buffer size of a storage component to a value larger than the size of available memory on the DSP. Verify that your circuit operates within the limits of your device. Devices contain different amounts of memory and processing power so individual applications will vary. Reduce the number of channels and/or buffer size to be processed.

Occurs when attempting to run a circuit that contains components assigned to a DSP that does not exist (i.e. DSP 5 on a 2 DSP RX device). Verify that your RPvdsEx circuit has not assigned components to a DSP (assigned pages or DSP assign components) that does not exist.

Glossary

A

asynchronous: describes buffers or events (typically, across multiple recording channels) that are NOT coordinated in time.

B

block: 1. In OpenEx, a group of data labeled and stored in the tank for the purpose of analysis. Typically, a block contains one recording session and may contain many sweeps. There may be one or more blocks in each data tank. Blocks are named (automatically or by the user) and can be selected for display or export. 2. A specified number of data points handled as a group for downloading from, or uploading to, a device. Breaking data into chunks for data transfer increases the efficiency of the system. The block size is defined in OpenEx header components such as oxSnippet and oxStream.

C

circuit: a configuration of processing components. Each component does a set task, such as generate a waveform, store in memory, or send a signal to the DAC outs. Circuits are designed using RPvdsEx software and are run on System 3 Real-Time Processors.

client: the requesting program or user in a client/server relationship. For Example, OpenScope is a client application that requests data from the TTank data server in the OpenEx client application.

compiled circuit file: RP control object, or compiled circuit, designed for use with OpenEx or other TDT applications. The System 3 real-time processing modules are controlled using these files, which are compiled from circuits designed using TDT's RP visual design studio (RPvdsEx). Users can generate their own compiled circuit files for use with OpenEx or select one of the standard compiled circuit files provided by TDT.

construct: a group of components (in a circuit) that perform a defined task in OpenEx. For example: a triggered scalar construct stores single data values for later analysis. Most circuit constructs have a minimum or required component structure and secondary or alternate component structures.

continuous decimated data: signals that are acquired and filtered, then decimated and stored to a buffer.

D

Data types: 1. In OpenEx, standardized construct formats in which data is stored, such as snippet, buffer, list, stream, and scalar. 2. A description of data such as: float (32-bit floating-point value), integer (32-bit integer value), short (16-bit integer value), byte(8-bit integer value).

decimated data: data that has been reduced further than the sampling rate of the device for data storage. May refer to continuous decimated or plot decimated data. Data is decimated to reduce the amount of data stored to disk or being transferred from the hardware to the PC and in cases where very low sample rates are necessary.

device: a named group of OpenWorkbench settings which define which System 3 hardware (such as RP2, RL2, RA16, RXn, RZ, or RV8) or attenuators (PA5) are controlled from OpenWorkbench and what compiled circuit files will be used to control the specified hardware. Also: the hardware component specified in the Device settings.

E

epoch: an event (or sections of a tank block) that are associated with the tank's timeline. Epoch events can be scalar variables including triggered scalars, data lists, and their associated secondary tags. Epoch events can be used by other OpenEx applications such as OpenScope and OpenBrowser to sort and display tank data.

event: data that is stored in the data tank, such as a scalar value, snippet waveform, or continuous waveform. Note: not all significant occurrences (e.g. spikes) are events. In OpenEx an event refers only to stored data.

H

hand shaking: an optional protocol where a flag (sync tag) is set to signify that data is ready for downloading and OpenWorkbench resets the flag after the data has been downloaded. Often used with oxBuffer stores.

I

Idle: an OpenWorkbench protocol mode in which devices are not loaded and are not running. All values are cleared from the hardware including values set in OpenController.

index: 1. The logical number of a hardware device. The zBUSmon application shows the logical number of all programmable devices in the workstation. Multiple devices of the same type, such as two RP2s, must have different index values. Devices of different types can have the same index value. 2. A number assigned to an RPvdsEx component within a circuit that indicates its position in the processing chain that is the order in which components will be executed.

M

master polling rate: the rate at which OpenWorkbench polls devices for new data. A high polling rate means that data is read more rapidly. However, a high polling rate decreases system efficiency.

P

parameter tag: a specialized helper component within a circuit that allows users to modify parameter values through OpenEx or other software control. By utilizing these tags, users can control the experiment in real-time.

plot decimated data: a form of decimation where only the maximum and minimum values are stored for each chunk of data (e.g. 64 samples). Data in this format allows users to visualize the maximum noise floor and spike activity of an incoming signal; however, it is not a true

representation of the acquired signal. It is used to get an approximation for real-time plotting without requiring the transfer of a large amount of data.

Preview: an OpenWorkbench protocol mode in which data is saved to a temporary block in the tank. This mode allows the user to view data in OpenController or OpenScope without permanently storing data.

protocol: the method used to present stimuli and/or acquire data.

R

Record: an OpenWorkbench protocol mode in which devices are loaded and running and data is saved to the tank.

RPvdsEx file: a file that contains an uncompiled circuit, designed in a visual drag-and-drop environment.

S

scalar: a single value, or series of values, that may be stored as data. May also be used to refer to the Triggered Scalar (oxScalar) data construct.

secondary tag: a parameter tag that has been defined as such on an OpenWorkbench Store. By configuring a parameter tag as a secondary tag, data read from the tag can be saved using the construct and time stamp association with an existing Store. Using secondary tags simplifies circuit design by eliminating some components.

server: a program that awaits and fulfills requests from client programs in the same or other computers. An application may function as a client with requests for services from other programs and also as a server of requests from other programs. For example: TTank is a server that responds to requests for data storage and retrieval. May also refer to the computer where a server program is located.

Standby: an OpenWorkbench protocol in which devices are loaded and running but signals aren't being acquired and saved to disk. This mode allows the user to modify parameter values through OpenController.

Store: a named group of OpenWorkbench settings that pull together all the information needed to store data. Each store is associated with a data construct within the compiled circuit file running on the Store's Host Device. Also, the data construct used by the Store, or the data stored by the Store.

Sync: a tag that tells OpenEx when data is ready to be downloaded. May be connected to a FlipFlop for handshaking stores or an index value that indicates the position of the buffer and tells OpenEx how many points are to be downloaded to the tank or if any points at all require downloading. The parameter tag associated with a Sync is identified by an s prefix.

synchronous: describes buffers or events that are coordinated in time, typically across multiple recording channels.

T

tank: a group of data stored by OpenEx's TTank data server or the files used to store the group of data.

target: Points to the location of data being read or the location to which a value will be read. This location might be an OpenWorkbench Store, a parameter tag within a compiled circuit file running on a device, or another control setting.

time stamp: the precise time of an event that is recorded to the tank. The precision of the time stamp depends upon the sample clock. Parameter tags associated with a time stamp are identified

by a t prefix. Typically, the time values will be latched periodically when data needs to be stored. Streaming data (continuous) does not require time stamping. Time stamps should not be confused with the RpvdsEx component "TimeStamp" which is used by the RV8.

~

Index

7	
7 segment display.....	132
creating	133
overview	132
A	
acquisition control.....	110
Advance Setup dialog box.....	98, 100
Arbitrary sample rates	98
B	
biquad coefficient generator	177
creating	178
overview	177
C	
changing file names.....	51, 56
circuit constructs	63, 315
acquisition	328
asynchronous next condition	325
asynchronous next sweep	322
asynchronous scalar	330
biquad filtering.....	75, 347
buffer	332
clock generator.....	319
condition.....	323
condition control with end checking	324
continuous waveform	341
control.....	65, 318
latch	343
list	335
multilatch	344
naming conventions	315
nesting - basic	326
nesting with end tracking.....	327
other timing.....	329
overview	63, 315
serial store.....	345
SigGen control.....	347
signal snippets.....	337, 339
stimulation	329
sweep - basic	320
sweep with end checking	321
trigger	318
trigger- secondary	319
cleaning the project.....	56
client/server approach	7
condition loop.....	109
configuring export	282
constructs.....	63, 315
controls - OpenContorller.....	115
modifiers.....	116
visualization tools	115

D	
data export.....	271
export configuration	282
exporting	282
overview	271
previewing data	278
selecting data.....	274, 275
data generating constructs	80
choosing a data construct	66
overview	80
type 1	
asynchronous scalar data	66, 67, 80, 330
type 2	
data buffer	66, 67, 80, 332
type 3	
data list	66, 67, 80, 335
type 4	
signal snippets.....	66, 67, 71, 80, 337
signal snippets with spike sorting	66, 67, 71, 80, 339
type 5	
continuous waveform	66, 67, 80, 341
data tables	
creating	165
formulas	167
delays	106
Device Navigator	83
Devices	
configuring.....	83, 94, 98
E	
epochs	81
overview	81
selecting in OpenBrowser	275
using with OpenScope	228
errors.....	85
exporting data	282
configuring.....	282
exporting.....	282
OpenBrowser overview	271
previewing data	278
selecting data	274, 275
F	
file names.....	51
frames	180
creating.....	181
overview	180
G	
guages	130
I	
importing applications	55
initializing tags.....	100
input box	145
creating.....	145
overview	145
K	
knobs	150
creating.....	151
overview	150
L	
launch settings	53
led caption.....	135
creating.....	136
overview	135

led indicator	135	modifiers	116
creating	135	overview	115
overview	135	Run! mode	125
linear guages	130	targets	116, 123, 184
creating	130	visualization tools	115
overview	130	workspace	119
linking controls	184	OpenProject	49
example	185	creating	50, 53
overview	184	importing applications	55
logarithmic gauge	130	overview	49
creating	131	working with data tanks	54
overview	130	OpenScope	225
M		dialog boxes	232
master mode control	164	overview	225
creating	164	workspace	230
overview	118, 164	OpenWorkbench	79
master parameters	116, 123	overview	79
messages window	85	workspace	79
N		P	
naming conventions - tags	315	period	108
numeric display	132	plots - OpenScope	225
O		activity	257
OpenBrowser	271	adding	225
exporting data	282	chart	255
overview	271	feature	252
workspace	271	histograms	245
OpenController	115	modifying	226
Design mode	120	pile	239
dialog boxes	121	raster	248
		scroll	242
		selecting data	239
		XY	251
		plots and graphs - OpenController	137
		creating a feature plot	143

creating a scrolling plot	142	choosing a spike component.....	71
creating chart plots.....	141	circuit	339
creating pile plots	137	creating snippet sort control	155
creating scope plots	139	using snippet sort control	158
overview	137	status indicators	135
polling rate	105	stimulus control	110
R		storage specification table	96, 101
RCO Files	83, 94, 98	Stores	
removing files.....	58	configuring.....	96
S		sweep loop.....	108
sampling rate	98	switch button	146
scripting in OpenController		creating.....	147
creating a VB script control	169	overview	146
debugging	176	switches	146
running	176	system controls - OpenWorkbench.....	84
writing.....	171	system controls -OpenScope.....	231
secondary tags	101	T	
server		tag initialization	100
database server	6	Tank Monitor	301
hardware server	5	Tanks	82
SigGen Engine control.....	181	formats	82
creating	182	registering.....	82
overview	181	selecting	82, 103
slide switch	146	selecting in OpenScope	231
creating	149	tanks in OpenProject	54
overview	146	targets	116
sliders	150	initialization.....	100
creating	150	linking controls.....	184, 185
overview	150	selecting	123
spike sorting			

Time Control Window	233	value watch	132
timing	106, 110	creating.....	134
Triggered Scalar	80	overview	132
triggering.....	106, 108	 	
U		VBScript control	
under one second design	66	creating.....	169
V		debugging scripts	176
value inputs.....	145	running scripts	176
		writing scripts.....	171
		W	
		Workbench Plotting.....	86