

# **ActiveX Reference Manual**

---

***DT***

ActiveX Reference Manual

**Copyright**

©2000-2012 Tucker-Davis Technologies, Inc. (TDT). All rights reserved.

No part of this manual may be reproduced or transmitted in any form or by any means, electronic or mechanical, including photocopying and recording, for any purpose without the express written permission of TDT.

**Licenses and Trademarks**

Windows Vista and Windows XP are registered trademarks of Microsoft Corporation.

Updated: 1/31/2012 10:30 AM

# Table of Contents

<b>Before You Begin:</b> .....	<b>1</b>
Requirements.....	1
ActiveX Updates .....	1
Organization of the Manual.....	1
<b>TDT ActiveX Overview</b> .....	<b>3</b>
The ActiveX Controls.....	3
Controlling TDT Real-Time Processors using the RPcoX ActiveX Controls.....	3
<b>Using ActiveX with Common Programming Languages</b> .....	<b>5</b>
MATLAB ActiveX.....	5
Interfacing with TDT Devices through ActiveX Controls .....	5
RP Example Programs.....	6
Using ActiveX Controls With More Than One TDT Module.....	7
Using Older Versions of MATLAB .....	7
Visual Basic ActiveX .....	8
Interfacing with TDT Devices through ActiveX Controls .....	8
Adding ActiveX Controls in VB2005 .....	8
Adding ActiveX Controls in VB6 .....	13
Visual Basic Examples.....	16
Visual C++ ActiveX.....	18
Interfacing with TDT Devices through ActiveX Controls .....	18
Adding ActiveX Controls in VC++ 2005.....	18
Adding a Member Variable.....	21
Programming Multiple Modules.....	22
Visual C++ Examples.....	22

Delphi Function Headers .....	23
Working with Control Object Files (*.rco and *.rcx).....	24
Creating an RCO for Legacy Formats .....	25
<b>RPcoX Real-Time Processor Control .....</b>	<b>27</b>
About the RPcoX Methods.....	27
Device Connection .....	27
ConnectRP2.....	27
ConnectRA16 .....	28
ConnectRL2.....	28
ConnectRV8 .....	29
ConnectRM1 .....	30
ConnectRM2 .....	31
ConnectRX5 .....	31
ConnectRX6 .....	32
ConnectRX7 .....	33
ConnectRX8 .....	33
ConnectRZ2.....	34
ConnectRZ5.....	35
ConnectRZ6.....	35
File and Program Control .....	37
About the File and Program Control Methods.....	37
ClearCOF.....	37
LoadCOF .....	37
LoadCOFsf .....	38
ReadCOF .....	40

Run .....	40
Halt .....	41
Device Status .....	42
About the Device Status Methods .....	42
GetStatus .....	42
GetCycUse.....	44
GetSFreq.....	44
GetNumOf.....	44
GetNameOf .....	45
Tag Status and Manipulation.....	46
About the Tag Status and Manipulation Methods .....	46
GetTagVal .....	46
GetTagType.....	47
GetTagSize .....	48
ReadTag.....	48
ReadTagV.....	49
ReadTagVEX .....	49
SetTagVal.....	51
WriteTag.....	51
WriteTagV.....	52
WriteTagVEX .....	53
ZeroTag .....	54
Other.....	54
GetDevCfg.....	54
SetDevCfg .....	54

SoftTrg.....	56
SendParTable.....	57
SendSrcFile .....	58
<b>PA5 Programmable Attenuator .....</b>	<b>59</b>
About the PA5x Methods .....	59
ConnectPA5.....	59
Display.....	60
GetError.....	60
GetAtten .....	61
Reset .....	61
SetAtten .....	61
SetUser .....	62
<b>zBUS Device .....</b>	<b>65</b>
About the zBUSx Methods.....	65
ConnectZBUS .....	65
FlushIO.....	66
GetDeviceAddr.....	66
GetDeviceVersion .....	67
GetError.....	67
HardwareReset .....	68
zBusTrigA/zBusTrigB.....	68
zBusSync .....	70
<b>ActiveX Examples.....</b>	<b>71</b>
MATLAB Examples .....	72
MATLAB Example: Circuit Loader.....	72

MATLAB Example: Device Checker .....	73
MATLAB Example: Band Limited Noise.....	74
MATLAB Example: Continuous Acquire.....	76
MATLAB Example: Continuous Play.....	79
MATLAB Example: FIR Filtered Noise .....	81
MATLAB Example: Two Channel Acquisition with ReadTagVEX .....	83
MATLAB example: Two Channel Play with WriteTagVEX.....	85
Visual Basic Examples – VB2005.....	87
VB2005 Example: Circuit Loader.....	87
VB2005 Example: Band Limited Noise .....	89
VB2005 Example: Continuous Acquire .....	92
VB2005 Example: Continuous Play .....	94
VB2005 Example: Two Channel Acquisition .....	97
VB2005 Example: Two Channel Play.....	100
VB2005 Example: Read Data.....	102
Visual Basic Examples – VB6.....	104
VB6 Example: CircuitLoader.....	104
VB6 Example: Band Limited Noise .....	105
VB6 Example: Continuous Acquire .....	109
VB6 Example: Continuous Play.....	111
VB6 Example: Two Channel Play.....	116
VB6 Example: Read Data.....	118
Visual C++ Examples.....	120
Visual C++ Example: Circuit Loader.....	120
Visual C++ Example: Band Limited Noise .....	122

## ActiveX Reference Manual

Visual C++ Example: Continuous Acquire .....	125
Visual C++ Example: Continuous Play .....	127
Visual C++ Example: TDT ActiveX Console .....	130
<b>Revision History .....</b>	<b>133</b>
<b>Known Anomalies.....</b>	<b>135</b>
<b>Index .....</b>	<b>137</b>



# Before You Begin:

## *Requirements*

TDT Drivers must be installed before installing TDT ActiveX Controls.

The recommended operating system for all TDT systems is Windows 7®.

**Note:** Version 7.4 and greater installations include both 32-bit and 64-bit versions of the activeX controls.

## *ActiveX Updates*

Always ensure that you are using the same versions of ActiveX and the TDT Drivers. The version numbers should always be the same. To avoid problems, always upgrade TDT Drivers whenever you upgrade ActiveX. See the Revision History, page 133, for information about revisions and updates to the TDT ActiveX library.

## *Organization of the Manual*

*This manual is organized in the following sections:*

- Overview
- Language Specific Essentials
- RPcoX Real-Time Processor Control
- PA5 Programable Attenuator Controls
- ZBus Device Controls
- Examples

~

# TDT ActiveX Overview

TDT's ActiveX Controls provide a simple and powerful way to control TDT System 3 hardware modules from custom software applications running on a PC. ActiveX controls can be run from within an application program written in programming languages such as MATLAB, Visual Basic, Delphi, or Visual C++.

## *The ActiveX Controls*

The TDT ActiveX programming library includes three ActiveX controllers: RPcoX, PA5x, and ZBUSx.

### **RPcoX**

The RPcoX controller includes a versatile group of methods for the Classic Real-Time Processors (RP), Mobile Processors (RM), High Performance Processors (RX), and the Z-series Processors (RZ); making it possible to connect to hardware, load and run the RCO circuits on the hardware, and allow for flexible real-time control of the circuits loaded to the hardware.

### **PA5x**

The PA5x controller includes methods for real-time control of the PA5 front panel parameters, such as attenuation and attenuation stepsize.

### **ZBUSx**

The zBUSx controller includes methods that allow access to zBus control functions; such as flushing the IO, resetting the hardware, and triggering a zBus rack.

## *Controlling TDT Real-Time Processors using the RPcoX ActiveX Controls*

Some of the most powerful ActiveX methods are those that interact with the processing chains as they are executed on TDT real-time processors. The processing chain—the most basic instructions used to control a processor are designed in RPvdsEx and saved as a Control Object, either as a Control Object File (\*.rcf) or embedded in the RPvds Circuit File (\*.rcx). These files also contain special components called "parameter tags" that can be accessed via TDT ActiveX controls to implement real-time control. For more on RCOs, see page 24.

~

# Using ActiveX with Common Programming Languages

Each programming language implements ActiveX controls differently. This section provides a brief explanation of programming using ActiveX controls with:

- MATLAB
- MSVC++
- Visual Basic
- Delphi

This manual also includes examples that demonstrate how to implement the TDT ActiveX controllers for MATLAB, MSVC++, and Visual Basic.

## MATLAB ActiveX

MATLAB versions 5.3 and above support ActiveX controls. The primary MATLAB method call for using ActiveX controls is:

```
actxcontrol()
```

This method adds an ActiveX control to your program. Once the ActiveX control has been instantiated all of its ActiveX methods can be used.

### Interfacing with TDT Devices through ActiveX Controls

*The following three calls will get a circuit running on the processor device:*

- **Connect(device type)** - establishes a connection with the processor device
- **LoadCOF** - loads a Control Object file
- **Run** - runs the circuit

#### Example Code

```
RP=actxcontrol('RPco.x',  
[5 5 26 26])
```

Creates an ActiveX Control for the processor device, the second argument controls the placement of the icon in the MATLAB figure. The figure must remain open for ActiveX control methods to be called.

```
RP.ConnectRP2('GB',1) % MATLAB  
R13 and up
```

Calls the Connect function to the RP2 (a member of the RPx family) using the ActiveX control. Connects to the first RP2 via the Gigabit port.

```
RP.LoadCOF('C:\TDT\ActiveX\  
ActXExamples\RP_files\*.rcx')
```

Loads a processor device Control Object (\*.rcx or \*.rcx) file.

RP . Run

Starts the processor device processing chain.

Included with the ActiveX help are several examples of programs using the ActiveX controls with the RP2. Other TDT processor devices may be used with these example files by modifying the example code to connect to the specified device. We have also included the circuit Control Object File (\*.rcx). The examples include programs written for versions newer than MATLAB 6.0, specifically R13 and R14. If you are using an older version of MATLAB such as R12, please review the example files that were designed for older releases of MATLAB.

## RP Example Programs

### **Circuit Loader**, page 72

Demonstrates the basic ActiveX methods that are part of any program. The program starts an ActiveX control, connects to an RP2, and loads an \*.rco or \*.rcx file and runs it.

*Methods used:* ConnectRP2, ClearCOF, LoadCOF, Run, GetStatus

### **Device Checker**, page 73

Checks the components in a circuit that has been loaded and is running.

*Methods used:* GetCycUse, GetNumOf, GetNameOf, GetTagType, GetTagSize

### **Band-limited Noise**, page 74

Uses parameter tags to control the frequency and intensity of filtered noise.

*Methods used:* SetTagVal, GetTagVal

### **Continuous Play**, page 79

Plays a continuous set of tones generated in MATLAB.

*Methods used:* WriteTagV, SoftTrg, GetTagVal

### **Continuous Acquire**, page 76

Stores one channel of stream data to an f32 file.

*Methods used:* ReadTagV, SoftTrg, GetTagVal

### **FIR Filtered Noise**, page 81

Uses a noise component on the DSP to generate and filter it through an FIR.

*Methods used:* SendSrcFile, SendParTable

### **Two Channel Continuous Acquire**, page 83

Stores two channels of streaming data to a f32 file using ReadTagVEX.

*Methods used:* ReadTagVEX, SoftTrg, GetTagVal

**Two Channel Continuous Play**, page 85

Plays two sets of tones out of two DACs.

*Methods used:* WriteTagVEX

**Using ActiveX Controls With More Than One TDT Module**

When using ActiveX controls with multiple processor devices, create a separate ActiveX control for each module. For example, in the example code below the user can add code to talk to a different processor device by creating a second control with a different MATLAB handle (i.e. RP2\_2 instead of RP2\_1):

```
% TDT Module 1
RP2_1 = actxcontrol('RPco.x', [10, 5, 36, 26])
RP2_1.ConnectRP2('GB', 1) % This connects to RP2 module #1 via
the Gigabit interface
% TDT Module 2
RP2_2 = actxcontrol('RPco.x', [10, 5, 36, 26])
RP2_2.ConnectRP2('GB', 2) % This connects to RP2 module #2 via
the Gigabit interface
```

**Using Older Versions of MATLAB**

If using versions of MATLAB greater than release 12, the invoke() method is not required. If using MATLAB R12 or prior releases, the invoke() method is required. Examples of how the ConnectRP2 method should be called in older MATLAB releases are shown below.

```
invoke()
```

Calls the ActiveX methods used with a control object file (\*.rcx or \*.rcx).

```
invoke(RP, 'ConnectRP2', 'GB', 1) % MATLAB Prior to R13
```

**Important!:** MATLAB 6.0 (R12) requires that all variables that are to be used in numerical operations be cast as Doubles. These operations include: +, -, \*, ./, ^, :, and others. Compare statements such as <, >, == do not need the variable to be of type double. Changing your MATLAB code to work with MATLAB 6.0 (R12) requires that you cast the variables as DOUBLE. MATLAB 7 (R14) supports math on integer and single-precision data.

**For example:**

```
freq=invoke(RPx, 'GetTagVal', 'freq')
```

should be changed to

```
freq=double(invoke(RPx, 'GetTagVal', 'freq')) % MATLAB 6.0 (R12)
```

## Visual Basic ActiveX

Visual Basic supports ActiveX controls through a graphical interface. Controls are placed into frames in the same way that buttons and text boxes are added. The programmer then controls the circuit through calls to the ActiveX module. To use the ActiveX components for the Real-time processor family (RPcoX), the PA5 (PA5x), and the zBus (ZBUSx) you add them to your Visual Basic Program.

For Adding ActiveX Controls in VB6, see page 13.

For Adding ActiveX Controls in VB2005, see page 8.

### Interfacing with TDT Devices through ActiveX Controls

*The following three calls will get a circuit running on the processor device:*

- **Connect(device type)** - establishes a connection with the processor device
- **LoadCOF** - loads a Control Object file
- **Run** - runs the circuit

#### Example Code:

<code>RP2.ConnectRP2( "GB" , 1 )</code>	Calls the Connect method to the RP2 (a member of the RP family) using the ActiveX control. Connects to the first RP2 via the Gigabit port.
<code>RP2.ClearCOF</code>	Clears any circuit on the RP2 processor device.
<code>RP2.LoadCOF( "C:\TDT\ActiveX\ActXE xamples\RP_files\*.rcx" )</code>	Loads a processor device Control Object *.RCO (*.rco or *.rcx) File.
<code>RP2.Run</code>	Starts the processor device's processing chain.

### Adding ActiveX Controls in VB2005

Visual Basic supports ActiveX controls through a graphical interface. Controls are placed into frames in the same way that buttons and text boxes are added. The programmer then controls the circuit through calls to the ActiveX module. To use the ActiveX components for the Real-time processor family (RPcoX), the PA5 (PA5x), and the zBus (ZBUSx) you add them to your Visual Basic Program. To use ActiveX in VB2005 you'll need to add the desired control to the **Toolbox**

*To add an ActiveX Control in VB2005:*

1. Create a new **Windows Application** by selecting **Visual Basic** from the **Project Types** dialog box to the left.



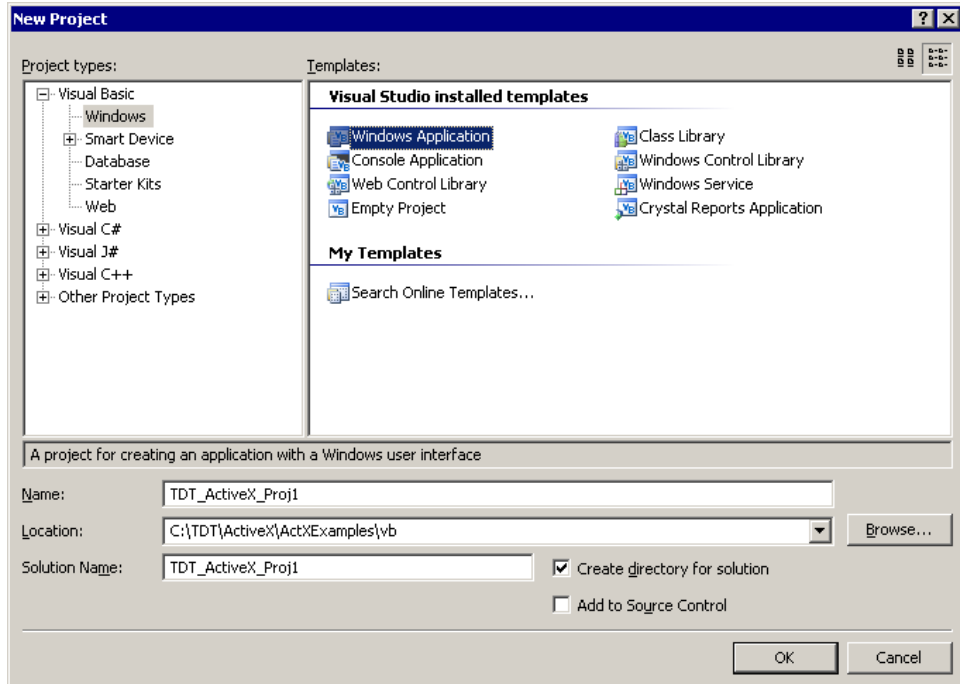

2. To display the **Toolbox**, Select **Toolbox** from the **View** menu.

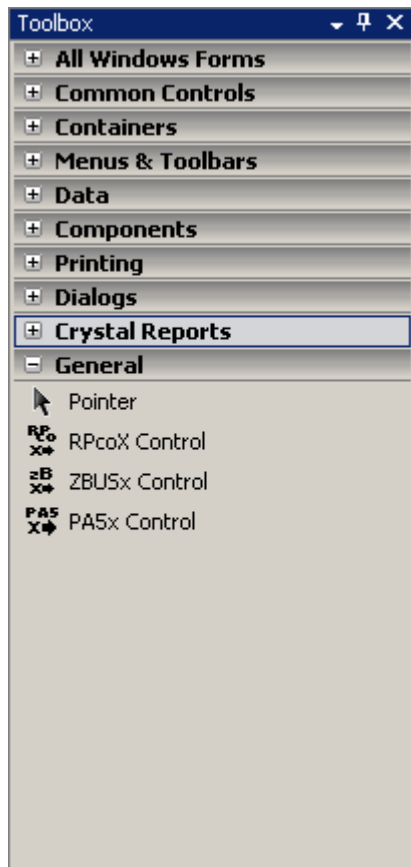

3. Next, add an ActiveX control, right-click in the **General** tab of the **Toolbox** and select **Choose Items**.

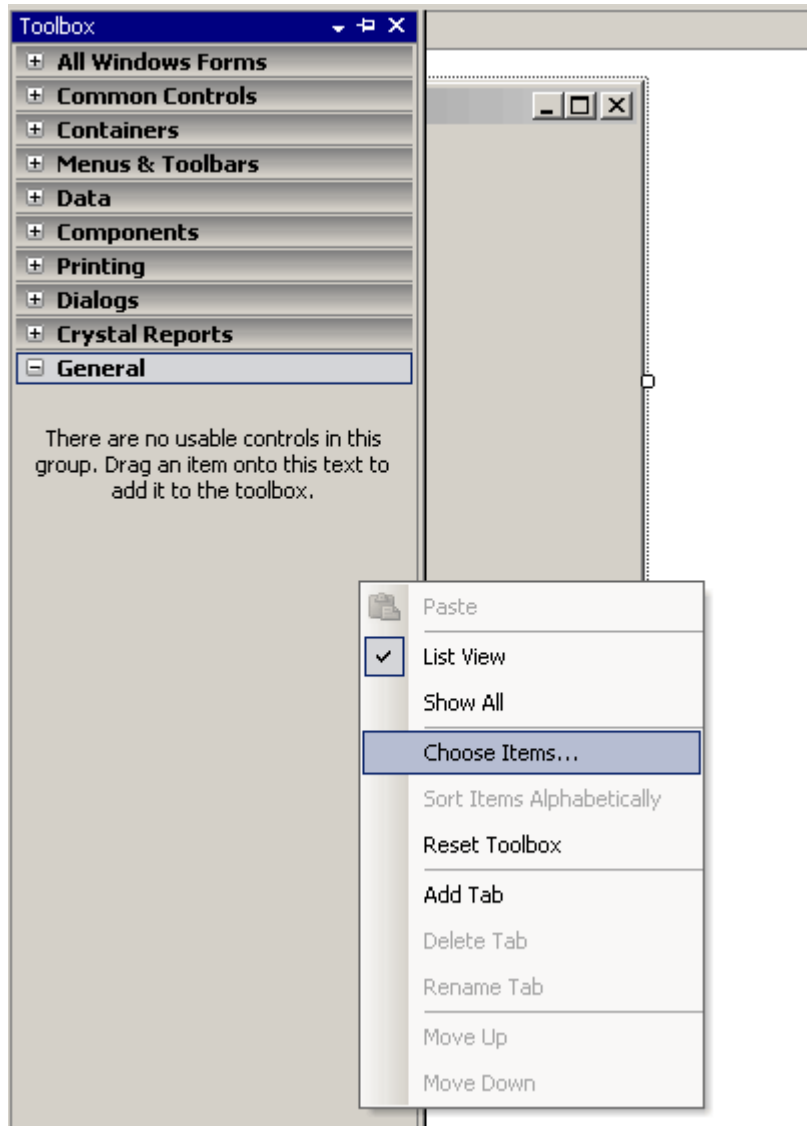

4. In the dialog box, click the **COM Components** tab. Scroll down the list and select the **RPCoX Control** check box, then click **OK**.

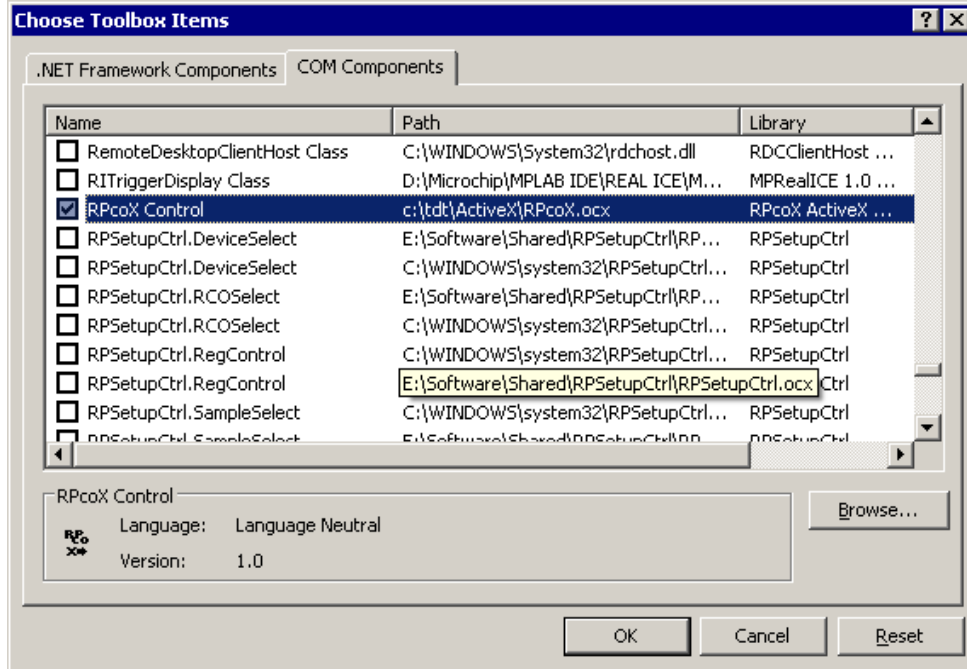

5. The **General** tab of the **Toolbox** should now contain the **RPcoX** control.

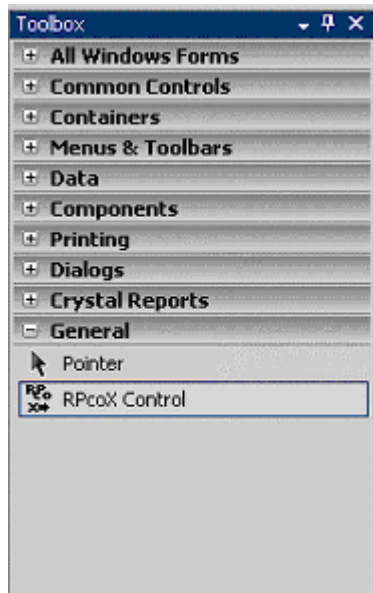

6. Click and drag the **RPcoX** control to your form.

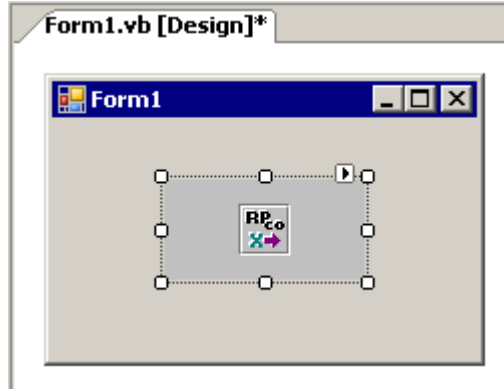

The default name for the new **RPcoX** control component is *AxRPcoX1*.

7. Repeat the steps above for any other TDT ActiveX control you wish to add (i.e. PA5x, ZBUSx).

### Displaying ActiveX Control Methods

In the code editor, type the name of the ActiveX control component (in this case *AxRPcoX1*) followed by a period to obtain a listing of the available methods and variable properties associated with that device.

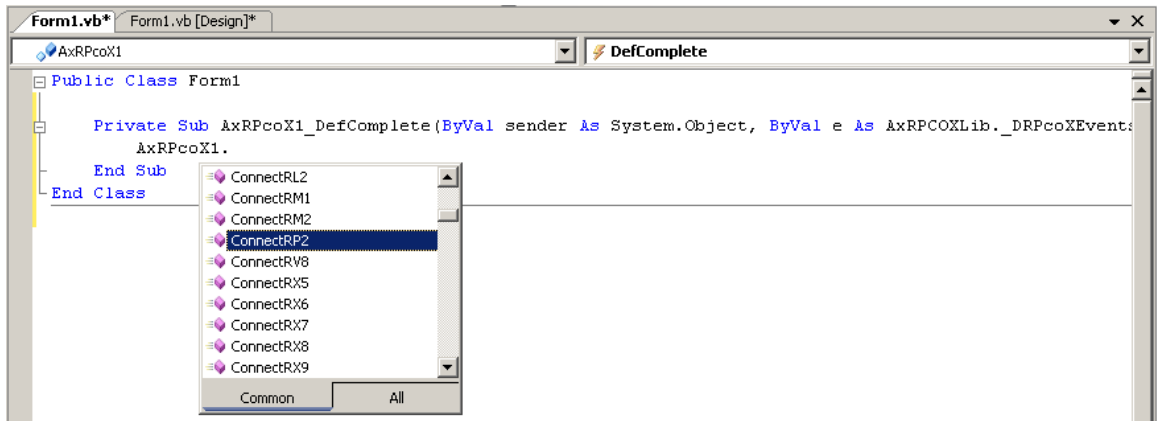

### Programming Multiple Modules

Each module should have its own ActiveX Control and its own variable. For example, to control two PA5 modules, insert two PA5x Controls. Each control will get its own variable.

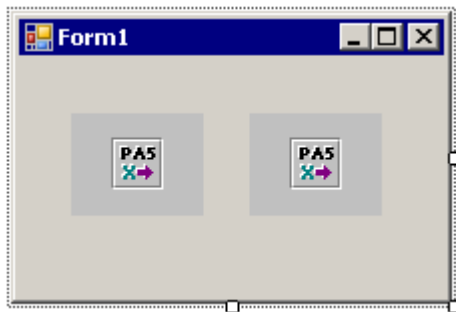

## Adding ActiveX Controls in VB6

Visual Basic supports ActiveX controls through a graphical interface. Controls are placed into frames in the same way that buttons and text boxes are added. The programmer then controls the circuit through calls to the ActiveX module. To use the ActiveX components for the Real-time processor family (RPscoX), the PA5 (PA5x), and the zBus (ZBUSx) you add them to your Visual Basic Program. To use ActiveX in VB6 you'll need to add the desired control to the **Toolbox**.

### To add an ActiveX Control in VB6:

1. Create a new **Standard EXE** project.

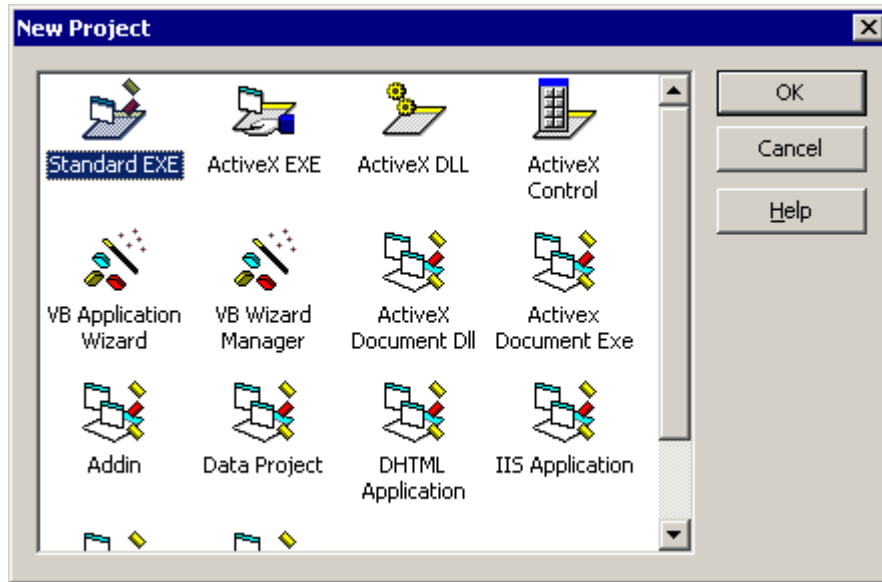

2. To display the **Toolbox**, Select **Toolbox** from the **View** menu.



3. Next, add an ActiveX control, right-click on an empty space in the **Toolbox** and select **Components**.

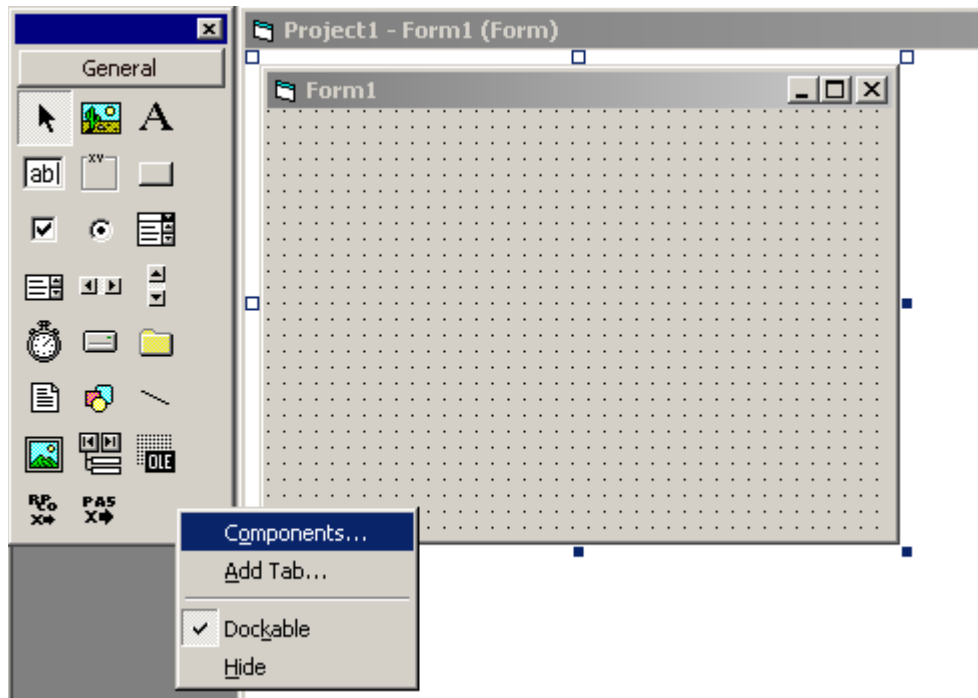

4. In the dialog box, click the **Controls** tab. Scroll down the list and select the **RPcoX ActiveX Control module** check box, then click **OK**.

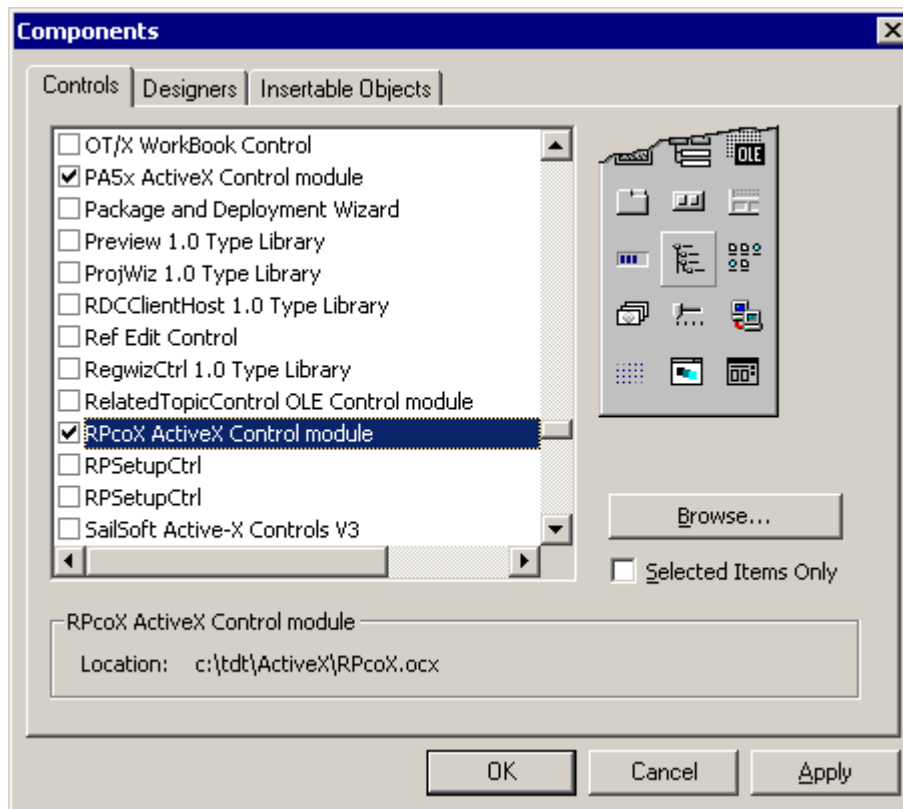

5. The **Toolbox** should now contain the **RPcoX** control.

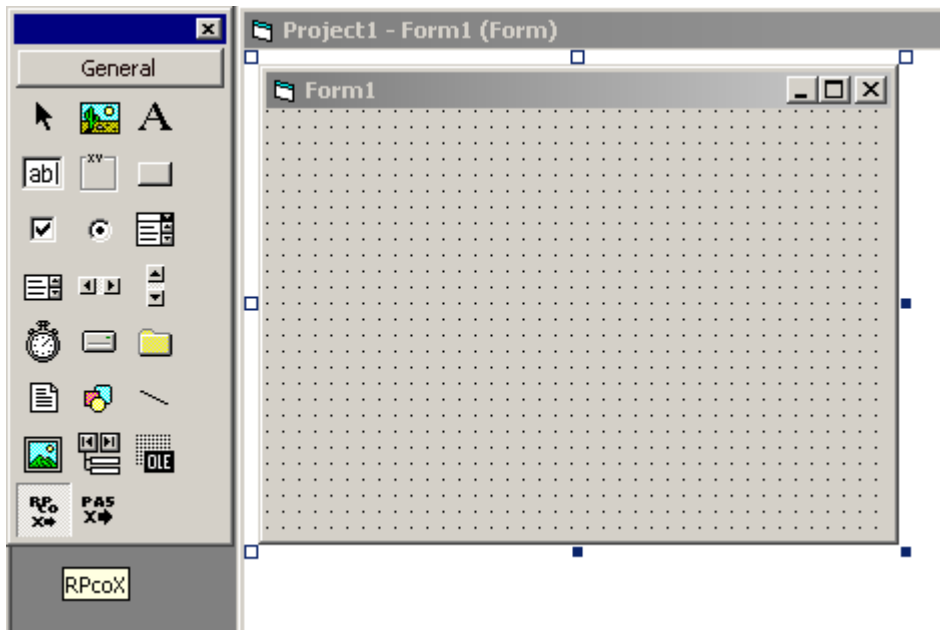

6. Click and drag the **RPcoX control** component to your form.

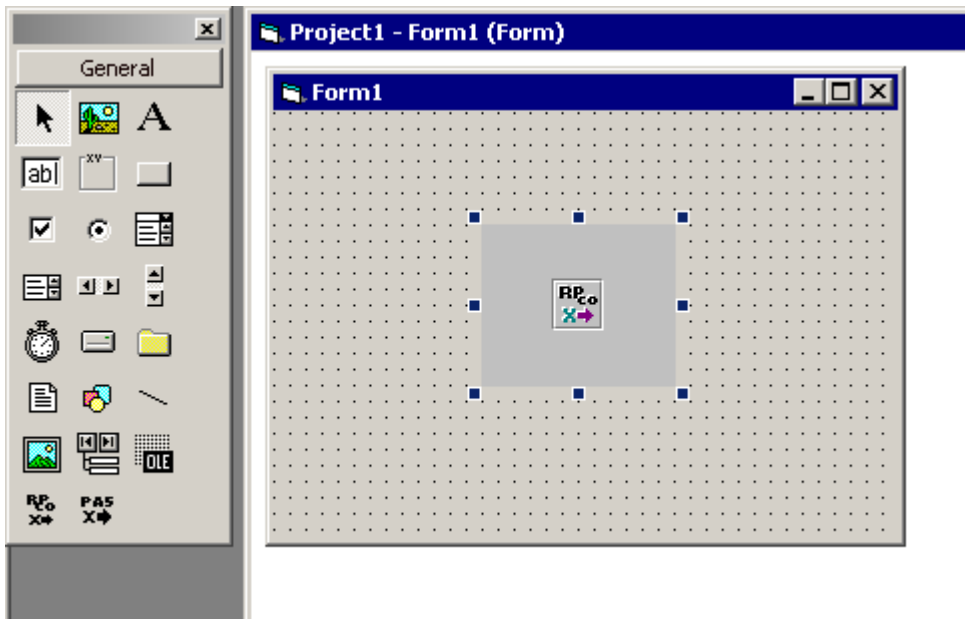

The default name for the new **RPcoX** control is *RPcoX1*.

7. Repeat the steps above for any other TDT ActiveX control you wish to add (i.e. PA5x, ZBUSx).

### Displaying ActiveX Control Methods

In the code editor, type the name of the ActiveX control component (in this case *RPcoX1*) followed by a period to obtain a listing of the available methods and variable properties associated with that device.

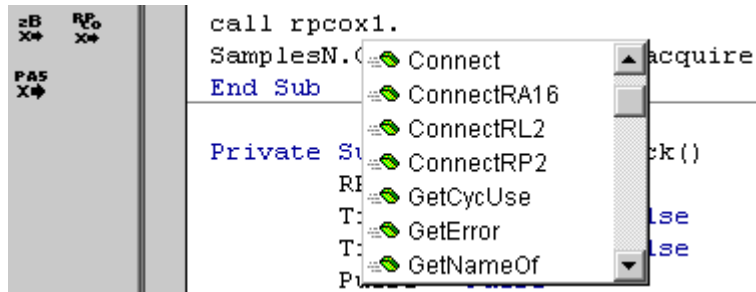

### Programming Multiple Modules

Each module should have its own ActiveX Control and its own variable. For example, to control two PA5 modules, insert two PA5x Controls. Each control will get its own variable.

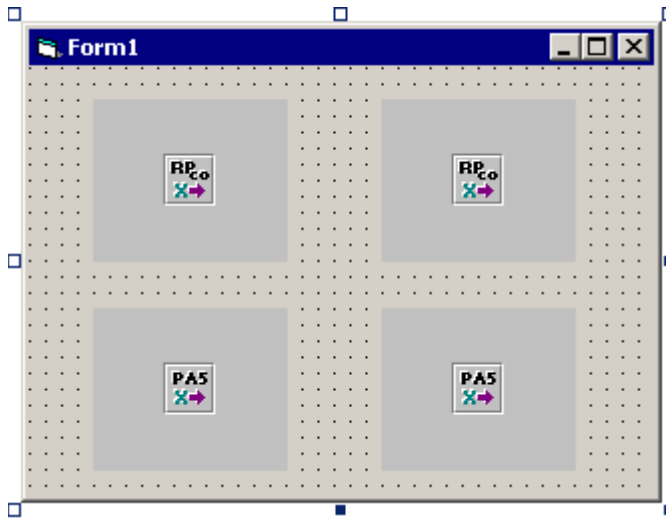

### Visual Basic Examples

Included with the ActiveX help are several examples of programs using the ActiveX controls with the RP2. We have included the circuit design file \*.rcx. TDT has included older VB6 examples and newer VB2005 examples. Please note that there are significant changes to the file structures of these two versions.

**Note:** In order to successfully run the VB2005 example exe files, .Net Framework 2.0 must be installed. MS Visual Studio 2005 will automatically install .Net Framework 2.0 or can be downloaded at <http://msdn2.microsoft.com/en-us/netframework/aa569263.aspx>.

#### Circuit Loader, page 87

Demonstrates the basic ActiveX methods that are part of any program: The program starts an ActiveX control, connects to an RP2, loads a \*.RCO (\*.rco or \*.rcx) file and runs it.

*Methods used:* ConnectRP2, LoadCOF, Run



**Read Data**, page 102

Reads either a 1-channel or 2-channel binary data file generated by the Continuous Acquire or Two Channel Continuous Acquire examples.

*Files used:* tones.dat, 2Chtones.dat

**Band Limited Noise**, page 89

Uses parameter tags to control the frequency and intensity of filtered noise.

*Methods used:* ConnectRP2, ClearCOF, LoadCOF, GetStatus, Run, Halt, SetTagVal, GetTagVal, GetCycUse

**Continuous Acquire**, page 92

Continuously acquires one channel of data and stores it on the PC at 100kHz.

*Methods used:* ReadTag, SoftTrg, GetTagVal

**Continuous Play**, page 94

Continuously plays sounds out of the RP2 that have been generated on the PC.

*Methods used:* WriteTag, SoftTrg, GetTagVal, GetTagSize

**Two Channel Continuous Acquire**, page 97

Same as Continuous Acquire except that it stores two channels of streaming data to a f32 file using ReadTagVEX.

*Methods used:* ConnectRP2, ClearCOF, LoadCOF, GetStatus, Run, SoftTrg, GetTagVal, ReadTagVEX

**Two Channel Continuous Play**, page 100

Plays two sets of tones out of two DACs.

*Methods used:* WriteTagVEX

## Visual C++ ActiveX

Visual C++ supports ActiveX controls through a graphical interface. Controls are placed into frames in the same way that buttons and text boxes are added. The programmer then controls the circuit through calls to the ActiveX module. To use the ActiveX components for the Real-time processor family (RPcoX), the PA5 (PA5x), and the zBus (ZBUSx) you add them to your Visual C++ Program.

For Adding ActiveX Controls in VC++ 2005, see page 18.

### Interfacing with TDT Devices through ActiveX Controls

*The following three calls will get a circuit running on the processor device:*

- **Connect (device type)** - establishes a connection with the processor device
- **LoadCOF** - loads a Control Object file
- **Run** - runs the circuit

#### Example Code:

<code>m_rp2.ConnectRP2( "GB", 1);</code>	Calls the Connect method to the RP2 (a member of the RP family) using the ActiveX control. Connects to the first RP2 via the Gigabit port.
<code>m_rp2.ClearCOF();</code>	Clears any circuit on the RP2 processor device.
<code>m_rp2.LoadCOF( "C:\\TDT\\ActiveX\\ActXExamples\\RP_files\\*.rcx" );</code>	Loads a processor device Control Object *.RCO (*.rco or *.rcx) File.
<code>m_rp2.Run();</code>	Starts the processor device's processing chain.

### Adding ActiveX Controls in VC++ 2005

To use the TDT ActiveX controls with Visual C++, you need to make a project that uses MFC with ActiveX support. The easiest way to do this is to use the MFC Application Wizard. Make sure that support for ActiveX controls is enabled (it should be enabled by default). Then you will be able to add ActiveX controls to the dialog and make member variables for them using ClassWizard (see below for more details). This example assumes you are creating the ActiveX Control in a dialog box.

#### *To use ActiveX in VC++ 2005:*

1. Create a project that uses an **MFC Application** with ActiveX support. Make sure that support for ActiveX controls is enabled (it should be enabled by default). Then you will be able to add ActiveX controls to the dialog and make member variables for them.

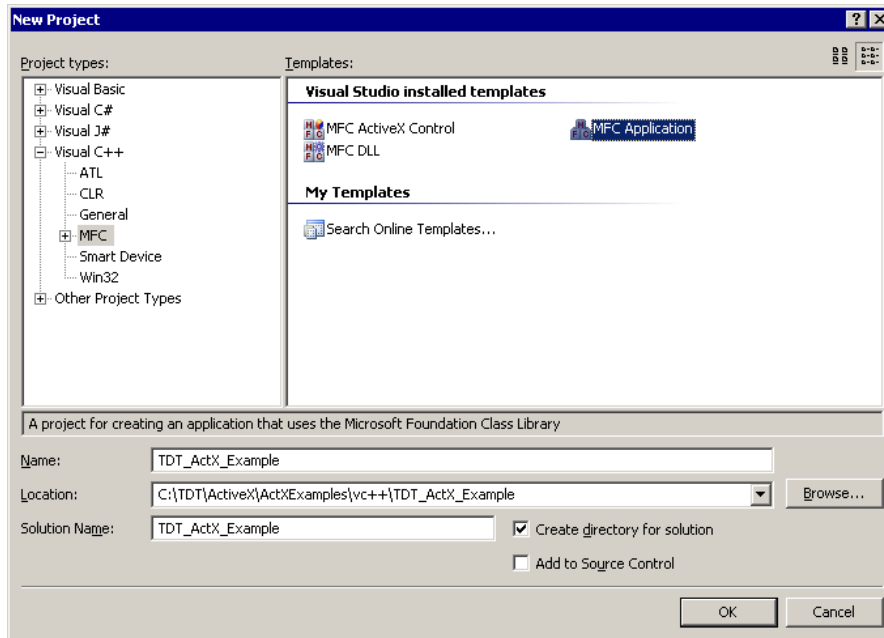

2. Follow the steps defined in the project wizard to create your **MFC Application**.
3. Under **Application type**, select the **Dialog based** radio button and click **Finish**.

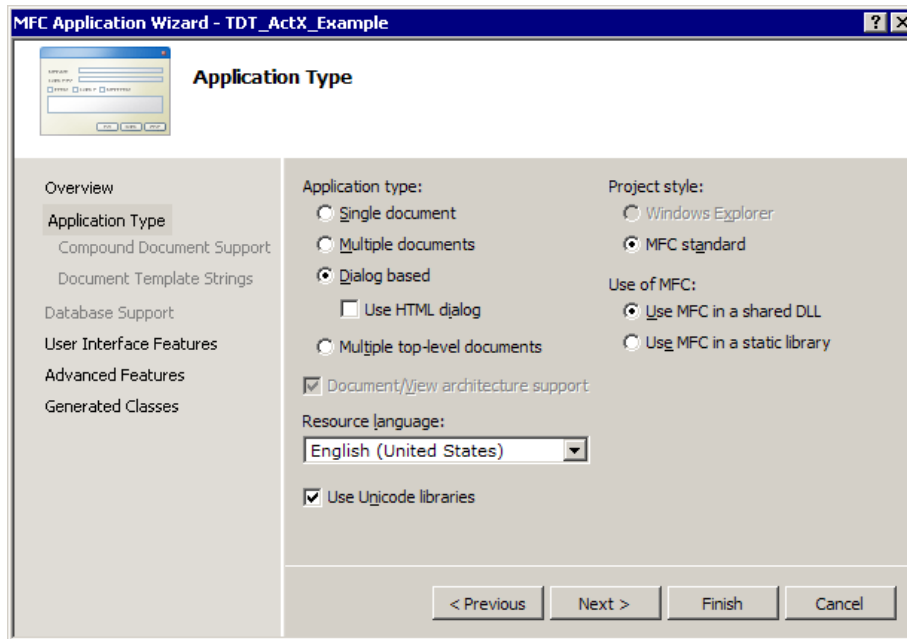

4. Under the **Resource View** dialog box, expand the **Dialog** folder and double click on **IDD\_YourProjectName\_DIALOG**.

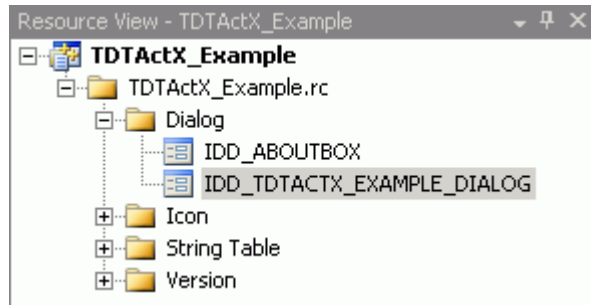

The dialog pane editor will then be shown in the workspace.

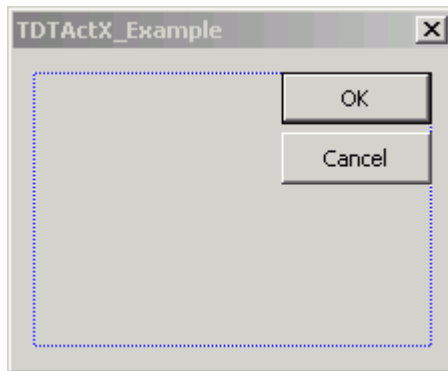

5. Right-click inside the blue dotted line on the dialog box and select **Insert ActiveX Control** from the menu.
6. Scroll down the list until you reach the desired ActiveX control (i.e. RPcoX, PA5x, or ZBUSx).

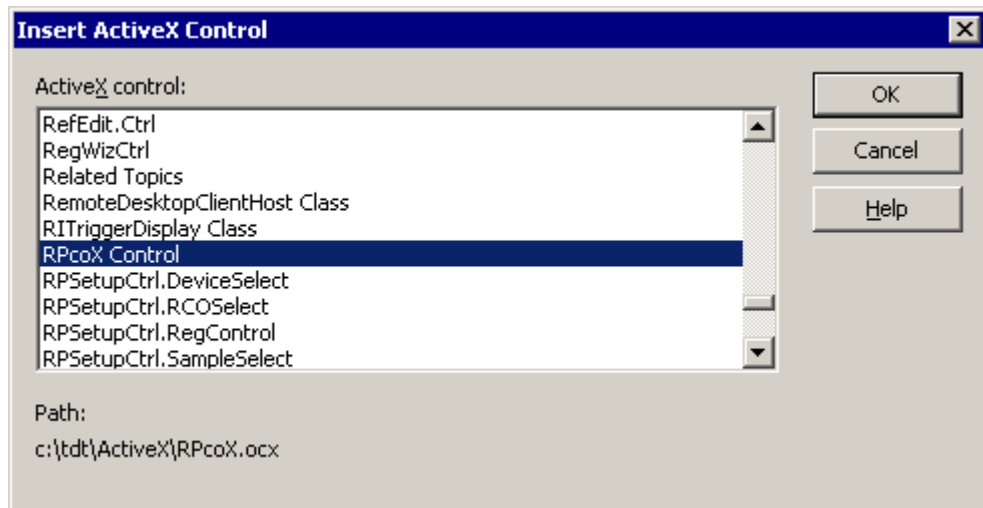

7. Click **OK**.
8. Drag the ActiveX control component to your dialog pane and place it in the desired location.

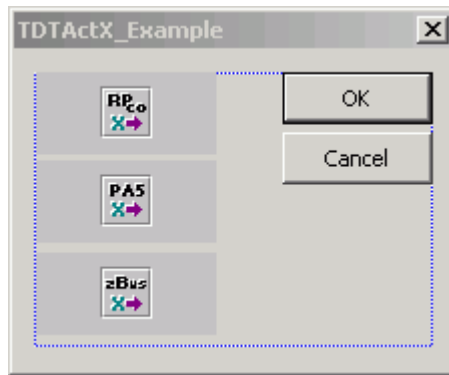

## Adding a Member Variable

Right-click on the ActiveX control and select **Add Variable**. When you add a variable for the control, VC++ will create a Class wrapper for the control.

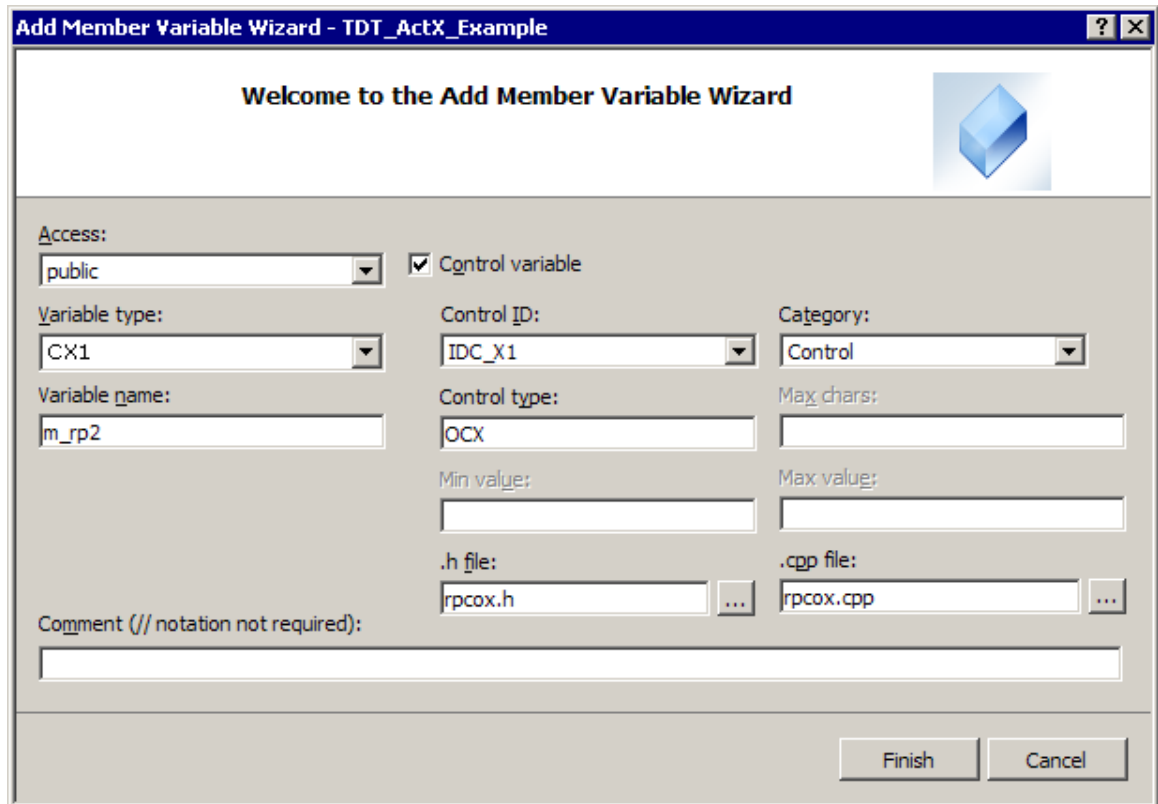

These variables are then used to call the ActiveX functions as shown below.

```
//Connect to RP2
m_rp2.ConnectRP2("GB", 1); //connect by GB to RP2 device #1
//Connect to PA5
m_pa5x1.ConnectPA5("USB", 1); //connect by USB to PA5 device #1
// Set Attenuation on PA5
m_pa5x1.SetAtten(20.0); //sets atten to 20 dB
```

## Programming Multiple Modules

Each module should have its own ActiveX Control and its own variable. For example, to control two PA5 modules, insert two PA5x Controls and add a member variable for each PA5 control.

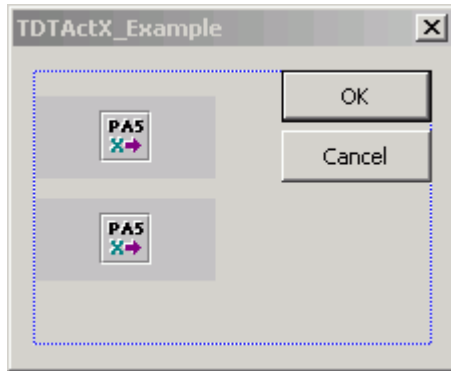

## Visual C++ Examples

Included with the ActiveX help are several examples of programs using the ActiveX controls with the RP2. Other TDT processor devices may be used with these example files by modifying the example code to connect to the specified device. We have included the circuit design file \*.rcx.

### **Circuit Loader**, page 120

Demonstrates the basic ActiveX methods that are part of any program: The program starts an ActiveX control, connects to an RP2, loads a \*.RCO (\*.rco or \*.rcx) file and runs it.

*Methods used:* ConnectRP2, LoadCOF, Run

### **Band Limited Noise**, page 122

Uses parameter tags to control the frequency and intensity of filtered noise.

*Methods used:* ConnectRP2, ClearCOF, LoadCOF, GetStatus, Run, Halt, SetTagVal, GetTagVal, GetCycUse

### **Continuous Acquire**, page 125

Continuously acquires data and stores it on the PC at 100kH. Generates the file fnoise2.f32

*Methods used:* ReadTag, SoftTrg, GetTagVal

### **Continuous Play**, page 127

Continuously plays sounds out of the RP2 that have been generated on the PC.

*Methods used:* WriteTag, SoftTrg, GetTagVal, GetTagSize

### **TDT ActiveX Console**, page 130

Demonstrates the usage of the system console by connecting to an RP2, loads a \*.RCO (\*.rco or \*.rcx) file and runs it.

*Methods used:* ConnectRP2, ClearCOF, LoadCOF, Run

## ***Delphi Function Headers***

All functions behave exactly the same in Delphi as they do in other programming languages. Users should refer to the RpcOx, PA5x, and ZBUSx sections of the ActiveX Help for details on how each function works. To determine the Delphi data types for each function and parameter, refer to the list below.

### **RpcOx**

```
function GetError: WideString;
function Connect(Interface_: Integer; DevNum: Integer): Integer;
function SetTagVal(const Name: WideString; Val: Single): Integer;
function LoadCOF(const FileName: WideString): Integer;
function Run: Integer;
function Halt: Integer;
function SoftTrg(Trg_Bitn: Integer): Integer;
function GetTagVal(const Name: WideString): Single;
function ReadTag(const Name: WideString; var pBuf: Single; nOS: Integer; nWords: Integer): Integer;
function WriteTag(const Name: WideString; var pBuf: Single; nOS: Integer; nWords: Integer): Integer;
function SendParTable(const Name: WideString; IndexID: Single): Integer;
function SendSrcFile(const Name: WideString; SeekOS: Integer; nWords: Integer): Integer;
function ReadTagV(const Name: WideString; nOS: Integer; nWords: Integer): OleVariant;
function WriteTagV(const Name: WideString; nOS: Integer; Buf: OleVariant): Integer;
function GetTagSize(const Name: WideString): Integer;
function GetTagType(const Name: WideString): Integer;
function GetNumOf(const ObjTypeName: WideString): Integer;
function GetNameOf(const ObjTypeName: WideString; Index: Integer): WideString;
function ReadCOF(const FileName: WideString): Integer;
function ConnectRP2(const IntName: WideString; DevNum: Integer): Integer;
function ConnectRL2(const IntName: WideString; DevNum: Integer): Integer;
function ConnectRA16(const IntName: WideString; DevNum: Integer): Integer;
function ReadTagVEX(const Name: WideString; nOS: Integer; nWords: Integer; const SrcType: WideString; const DstType: WideString; nChans: Integer): OleVariant;
function GetStatus: Integer;
function GetCycUse: Integer;
function ClearCOF: Integer;
function WriteTagVEX(const Name: WideString; nOS: Integer; const DstType: WideString; Buf: OleVariant): Integer;
```

```

function ZeroTag(const Name: WideString): Integer;
function GetSFreq: Single;
function ConnectRV8(const IntName: WideString; DevNum: Integer):
Integer;
function GetDevCfg(Addr: Integer; Width32: Integer): Integer;
function SetDevCfg(Addr: Integer; Val: Integer; Width32: Integer):
Integer;
function LoadCOFsf(const FileName: WideString; SampFreq: Single):
Integer;

```

**ZbusX**

```

function Connect(Interface_: Integer): Integer;
function GetDeviceAddr(DevType: Integer; DevNum: Integer):
Integer;
function GetDeviceVersion(DevType: Integer; DevNum: Integer):
Integer;
function HardwareReset(RackNum: Integer): Integer;
function FlushIO(RackNum: Integer): Integer;
function zBusTrigA(RackNum: Integer; zTrgMode: Integer; Delay:
Integer): Integer;
function zBusTrigB(RackNum: Integer; zTrgMode: Integer; Delay:
Integer): Integer;
function zBusSync(RackMask: Integer): Integer;
function GetError: WideString;
function GetDeviceAt(RackNum: Integer; PosNum: Integer; var DevID:
Integer; var DevNum: Integer): WideString;
function ConnectZBUS(const IntName: WideString): Integer;

```

**PA5x**

```

function Connect(Interface_: Integer; DevNum: Integer): WordBool;
function SetAtten(AttVal: Single): WordBool;
function GetAtten: Single;
function Reset: WordBool;
function SetUser(ParCode: Integer; Val: Single): WordBool;
function GetError: WideString;
function Display(const Text: WideString; Position: Integer):
WordBool;
function ConnectPA5(const IntName: WideString; DevNum: Integer):
Integer;

```

***Working with Control Object Files (\*.rco and \*.rcx)***

The Control Object File contains an object-oriented description of the circuit. When the circuit is loaded and run the Control Object File provides an interface between the processor device and the program using the Control Object (\*.rco or \*.rcx) File.

Once you have generated the circuit you can test it by running it within RpvdsEx. To check for problems Compile, Load, and Run the circuit before saving it as a Control Object File.



**Note:** The default preference for RPsVsEx is to embed the Control Object into an \*.rcx file. RPsVsEx files that are compiled in this embedded format generate only one file (\*.rcx) that has both the Control Object and Circuit Graphic file information.

Legacy formats use separate files for the Control Object and Circuit Graphic information. RPsVsEx preferences can be set to generate both an \*.rpx and \*.rco file for use with legacy formats.

## Creating an RCO for Legacy Formats

*To change the preferences in RPsVsEx for Legacy formats:*

1. Click **Preferences** on the Edit menu.
2. Click to clear the **Embed RCO object file** checkbox.

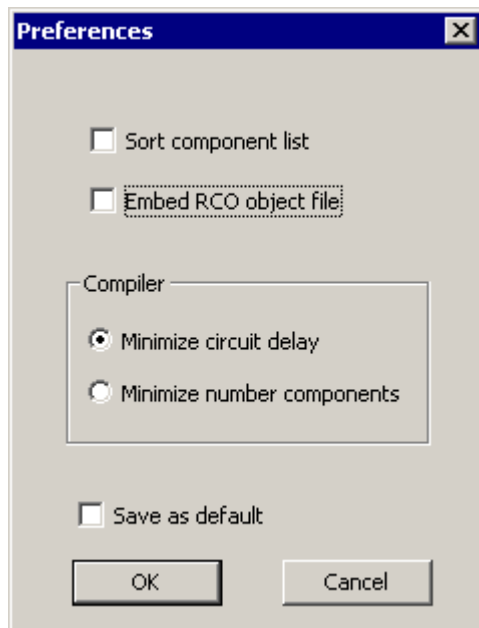

3. Click **OK**.

*To save the file as a Control Object File:*

1. Once the preferences above have been set, Click **Build Control Object** on the **Implement** menu or click the Build Control Object toolbar button.

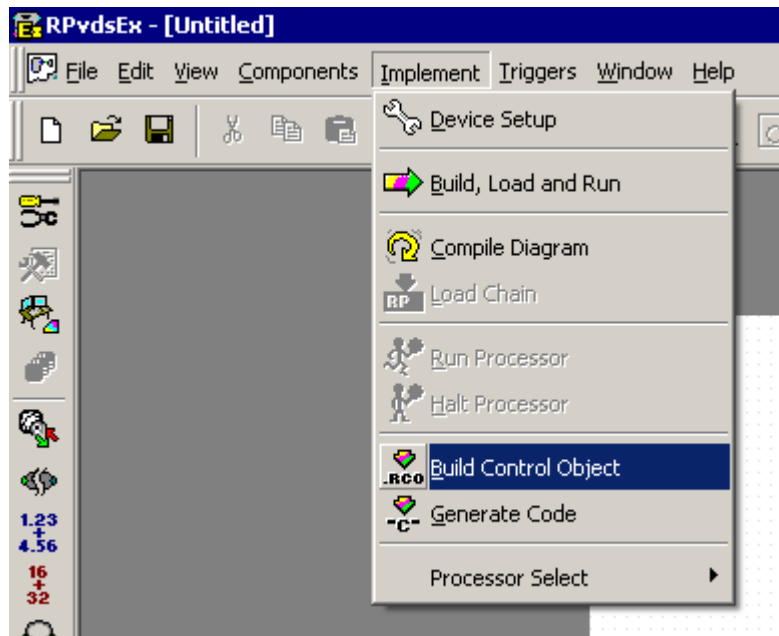

2. In the Save As dialog box, enter a file name then click **Save**.

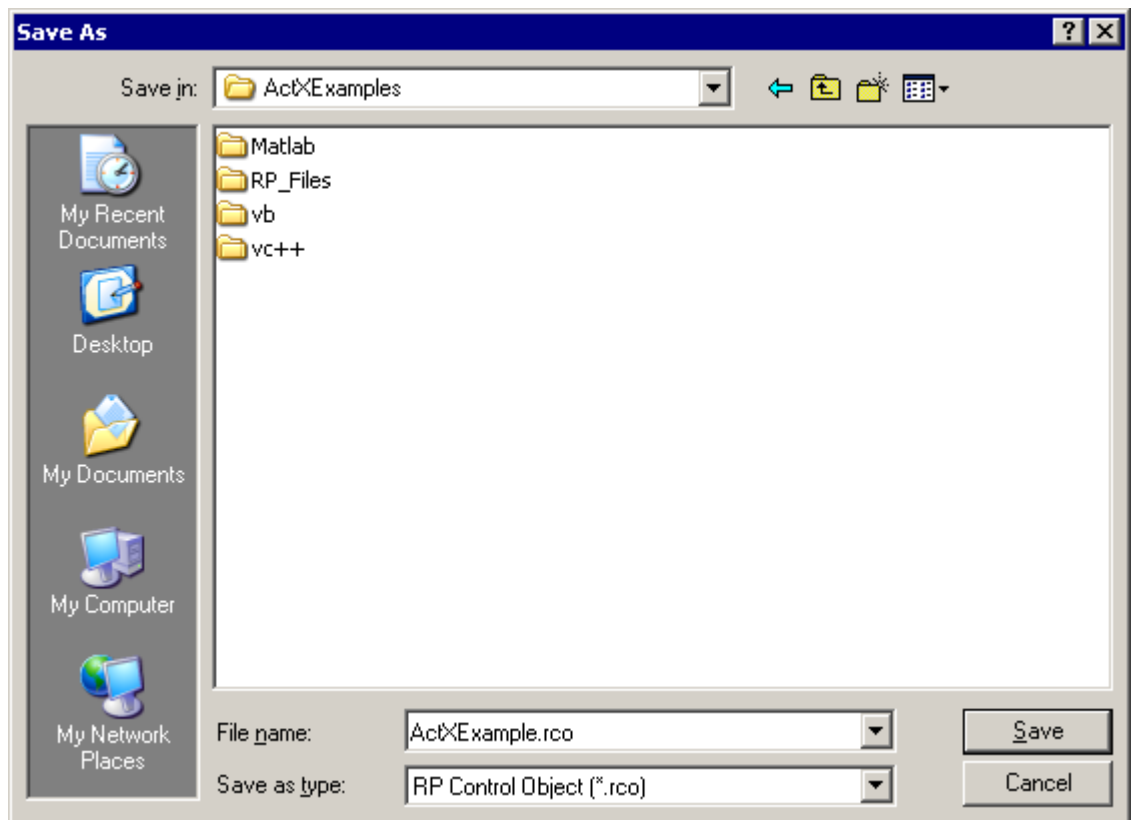

The saved \*.rco file can be used by any program compatible with TDT's ActiveX controls (e.g. Matlab, Visual Basic).

# RPcoX Real-Time Processor Control

## About the RPcoX Methods

This section provides a listing of the available RPcoX ActiveX control methods.

### Programming Steps:

- Add the RPcoX ActiveX controller to your program. The ActiveX help has examples for setting up ActiveX controllers in MATLAB, Visual Basic, and Visual C.
- Connect to a TDT processor (USB or GB) device with the matching device Connect function (i.e. for an RP2 use ConnectRP2).
- Control the device with the command and control functions using the ActiveX controller.

## Device Connection

The device connection methods are used to establish an RPcoX ActiveX control to the desired device.

### ConnectRP2

**Description:** Establishes a connection with an RP2 or RP2.1 Real-time Processor through a device interface (such as Gigabit or USB). A device number identifies which RP2 is connected.

**'C' Prototype:** `long ConnectRP2(LPCTSTR Interface, long DevNum);`

#### Arguments:

LPCTSTR	<i>Interface</i>	Interface to which the device is connected.
		<b>Argument</b> <b>Connection</b> <b>Part #s</b>
		'GB'            Gigabit            PI5/FI5, PO5/FO5
		'USB'           USB                UZ2, UB2, UZ1, UZ4
long	<i>DevNum</i>	Logical device number. Starts with 1 and counts upward for each device of a specified type.

#### Returns:

long	0	Connection not successful.
long	1	Connection successful.

**Note:** Invoke device connect commands only once to connect to a device, and then use ClearCOF and LoadCOF commands to upload or reload the control object to implement changes to the signal.

#### Sample Code:

```
MATLAB    %Connects to RP2 #1 via Gigabit
RP=activexcontrol('RPco.x',[5 5 26 26]);
if RP.ConnectRP2('GB',1)
```

```

                                e='connected'
                                else
                                e='Unable to connect'
                                end
Visual Basic 'Connects to the RP2 via the Gigabit
If RP.ConnectRP2("GB",1) Then
    msgbox "Connection established"
Else
    msgbox "Error connecting to RP2"
End If

```

**Example:** Circuit Loader, page 72.

## ConnectRA16

**Description:** Establishes a connection with the Medusa Base Station (RA16BA) via the Gigabit or USB bus interface. Invoking this method causes the control to search for the 16-channel preamplifier typically connected to the base station and establish a handle to the associated device driver. The ConnectRA16 method will return 1 if a connection was successfully established or 0 if the device is not present or is not functioning properly.

**'C' Prototype:** `long ConnectRA16(LPCTSTR Interface, long DevNum);`

**Arguments:**

LPCTSTR	<i>Interface</i>	Interface to which the device is connected.
		<b>Argument    Connection    Part #s</b>
		'GB'            Gigabit        PI5/FI5, PO5/FO5
		'USB'           USB            UZ2, UB2, UZ1, UZ4
long	<i>DevNum</i>	Logical device number. Starts with 1 and counts upward for each device of a specified type.

**Returns:**

long	0	Connection not successful.
long	1	Connection successful.

**Note:** Invoke device connect commands only once to connect to a device, and then use ClearCOF and LoadCOF commands to upload or reload the control object to implement changes to the signal.

**Sample Code:**

```

MATLAB % Connects to RA16 #1 via Gigabit
RL2=actxcontrol('RPco.x', [1 1 1 1])
if RL2.ConnectRA16('GB', 1)
    e= 'connected'
else
    e= 'Unable to connect'
end

```

## ConnectRL2

**Description:** Establishes a connection with the Stingray Docking Station (RL2) via the Gigabit or USB bus interface. Invoking this method causes the control to search for the specified device and establish a handle to the associated device driver.

The ConnectRL2 method will return 1 if a connection was successfully established or 0 if the device is not present or is not functioning properly.

**'C' Prototype:** `long ConnectRL2(LPCTSTR Interface, long DevNum);`

**Arguments:**

LPCTSTR	<i>Interface</i>	Interface to which the device is connected.
		<b>Argument    Connection    Part #s</b>
		'GB'          Gigabit          PI5/FI5, PO5/FO5
		'USB'         USB                UZ2, UB2, UZ1, UZ4
long	<i>DevNum</i>	Logical device number. Starts with 1 and counts upward for each device of a specified type.

**Returns:**

long	0	Connection not successful.
long	1	Connection successful.

**Note:** Invoke device connect commands only once to connect to a device, and then use ClearCOF and LoadCOF commands to upload or reload the control object to implement changes to the signal.

**Sample Code:**

```
MATLAB
% Connects to RL2 #1 via Gigabit
RL2=actxcontrol('RPco.x', [1 1 1 1])
if RL2.ConnectRL2('GB', 1)
    e= 'connected'
else
    e= 'Unable to connect'
end
```

## ConnectRV8

**Description:** Establishes a connection with the Barracuda Processor (RV8) through the Gigabit or USB interface. Invoking this method causes the control to search for the Barracuda and establish a handle to the associated device driver. The ConnectRV8 method will return 1 if a connection was successfully established or 0 if the device is not present or is not functioning properly.

**'C' Prototype:** `long ConnectRV8(LPCTSTR Interface, long DevNum);`

**Arguments:**

LPCTSTR	<i>Interface</i>	Interface to which the device is connected.
		<b>Argument    Connection    Part #s</b>
		'GB'          Gigabit          PI5/FI5, PO5/FO5
		'USB'         USB                UZ2, UB2, UZ1, UZ4
long	<i>DevNum</i>	Logical device number. Starts with 1 and counts upward for each device of a specified type.

**Returns:**

long	0	Connection not successful.
long	1	Connection successful.

**Note:** Invoke device connect commands only once to connect to a device, and then use ClearCOF and LoadCOF commands to upload or reload the control object to implement changes to the signal.

**Sample Code:**

```

MATLAB      %Connects to RV8 #1 via Gigabit
            RP=actxcontrol('RPco.x',[5 5 26 26]);
            if RP.ConnectRV8('GB',1)
                e='connected'
            else
                e='Unable to connect'
            end

Visual Basic 'Connects to the RV8 via the Gigabit
            If RP.ConnectRV8("GB",1) Then
                msgbox "Connection established"
            Else
                msgbox "Error connecting to RV8"
            End If

```

**ConnectRM1**

**Description:** Establishes a connection with a Mini Processor (RM1) using the device's built in USB interface.

**'C' Prototype:** `long ConnectRM1(LPCTSTR Interface, long DevNum);`

**Arguments:**

LPCTSTR	<i>Interface</i>	Interface to which the device is connected.
		<b>Argument</b> <b>Connection</b> <b>Part #s</b>
		'USB'        USB        Internal
long	<i>DevNum</i>	Logical device number. Starts with 1 and counts upward for each device of a specified type.

**Returns:**

long	0	Connection not successful.
long	1	Connection successful.

**Note:** Invoke device connect commands only once to connect to a device, and then use ClearCOF and LoadCOF commands to upload or reload the control object to implement changes to the signal.

**Sample Code:**

```

MATLAB:      %Connects to RM1 #1 via USB
            RP=actxcontrol('RPco.x',[5 5 26 26]);
            if RP.ConnectRM1('USB', 1)
                e='connected'
            else
                e='Unable to connect'
            end

Visual Basic: 'Connects to the RM1 via USB
            If RP.ConnectRM1("USB", 1) Then
                msgbox "Connection established"
            Else
                msgbox "Error connecting to RM1"
            End If

```

## ConnectRM2

**Description:** Establishes a connection with a Mobile Processor (RM2) using the device's built-in USB interface.

**'C' Prototype:** `long ConnectRM2(LPCTSTR Interface, long DevNum);`

**Arguments:**

LPCTSTR	<i>Interface</i>	Interface to which the device is connected.						
		<table border="0"> <thead> <tr> <th>Argument</th> <th>Connection</th> <th>Part #s</th> </tr> </thead> <tbody> <tr> <td>'USB'</td> <td>USB</td> <td>Internal</td> </tr> </tbody> </table>	Argument	Connection	Part #s	'USB'	USB	Internal
Argument	Connection	Part #s						
'USB'	USB	Internal						
long	<i>DevNum</i>	Logical device number. Starts with 1 and counts upward for each device of a specified type.						

**Returns:**

long	0	Connection not successful.
long	1	Connection successful.

**Note:** Invoke device connect commands only once to connect to a device, and then use ClearCOF and LoadCOF commands to upload or reload the control object to implement changes to the signal.

**Sample Code:**

```

MATLAB      %Connects to RM2 #1 via USB
            RP=actxcontrol('RPco.x',[5 5 26 26]);
            if RP.ConnectRM2('USB', 1)
               e='connected'
            else
               e='Unable to connect'
            end

Visual Basic 'Connects to the RM2 via USB
            If RP.ConnectRM2("USB", 1) Then
               msgbox "Connection established"
            Else
               msgbox "Error connecting to RM2"
            End If
    
```

## ConnectRX5

**Description:** Establishes a connection with a Pentusa Base Station (RX5) through a device interface (such as Gigabit or USB).

**'C' Prototype:** `long ConnectRX5(LPCTSTR Interface, long DevNum);`

**Arguments:**

LPCTSTR	<i>Interface</i>	Interface to which the device is connected.									
		<table border="0"> <thead> <tr> <th>Argument</th> <th>Connection</th> <th>Part #s</th> </tr> </thead> <tbody> <tr> <td>'GB'</td> <td>Gigabit</td> <td>PI5/FI5, PO5/FO5</td> </tr> <tr> <td>'USB'</td> <td>USB</td> <td>UZ2, UB2, UZ1, UZ4</td> </tr> </tbody> </table>	Argument	Connection	Part #s	'GB'	Gigabit	PI5/FI5, PO5/FO5	'USB'	USB	UZ2, UB2, UZ1, UZ4
Argument	Connection	Part #s									
'GB'	Gigabit	PI5/FI5, PO5/FO5									
'USB'	USB	UZ2, UB2, UZ1, UZ4									
long	<i>DevNum</i>	Logical device number. Starts with 1 and counts up for each device of a specified type.									

**Returns:**

long	0	Connection not successful.
------	---	----------------------------

long 1 Connection successful.

**Note:** Invoke device connect commands only once to connect to a device, and then use ClearCOF and LoadCOF commands to upload or reload the control object to implement changes to the signal.

**Sample Code:**

MATLAB `%Connects to RX5 #1 via Gigabit  
RP=actxcontrol('RPco.x',[5 5 26 26]);  
if RP.ConnectRX5('GB',1)  
    e='connected'  
else  
    e='Unable to connect'  
end`

Visual Basic `'Connects to the RX5 via the Gigabit  
If RP.ConnectRX5("GB",1) Then  
    msgbox "Connection established"  
Else  
    msgbox "Error connecting to RX5"  
End If`

**Example:** Circuit Loader, page 72.

## ConnectRX6

**Description:** ConnectRX6 establishes a connection with a MultiFunction Processor (RX6) through a device interface (such as Gigabit or USB).

**'C' Prototype:** `long ConnectRX6(LPCTSTR Interface, long DevNum);`

**Arguments:**

LPCTSTR	<i>Interface</i>	Interface to which the device is connected.
		<b>Argument    Connection    Part #s</b>
		'GB'          Gigabit          PI5/FI5, PO5/FO5
		'USB'         USB                UZ2, UB2, UZ1, UZ4
long	<i>DevNum</i>	Logical device number. Starts with 1 and counts up for each device of a specified type.

**Returns:**

long 0 Connection not successful.

long 1 Connection successful.

**Note:** Invoke device connect commands only once to connect to a device, and then use ClearCOF and LoadCOF commands to upload or reload the control object to implement changes to the signal.

**Sample Code:**

MATLAB `%Connects to RX6 #1 via Gigabit  
RP=actxcontrol('RPco.x',[5 5 26 26]);  
if RP.ConnectRX6('GB',1)  
    e='connected'  
else  
    e='Unable to connect'  
end`

Visual Basic `'Connects to the RX6 via the Gigabit  
If RP.ConnectRX6("GB",1) Then  
    msgbox "Connection established"  
Else`



```
msgbox "Error connecting to RX6"
End If
```

**Example:** Circuit Loader, page 72.

## ConnectRX7

**Description:** Establishes a connection with a MicroStimulator Base Station (RX7) through a device interface (such as Gigabit or USB).

**'C' Prototype:** `long ConnectRX7(LPCTSTR Interface, long DevNum);`

**Arguments:**

LPCTSTR	<i>Interface</i>	Interface to which the device is connected.
		<b>Argument    Connection    Part #s</b>
		'GB'          Gigabit          PI5/FI5, PO5/FO5
		'USB'        USB                UZ2, UB2, UZ1, UZ4
long	<i>DevNum</i>	Logical device number. Starts with 1 and counts up for each device of a specified type.

**Returns:**

long	0	Connection not successful.
long	1	Connection successful.

**Note:** Invoke device connect commands only once to connect to a device, and then use ClearCOF and LoadCOF commands to upload or reload the control object to implement changes to the signal.

**Sample Code:**

```
MATLAB %Connects to RX7 #1 via Gigabit
RP=actxcontrol('RPco.x',[5 5 26 26]);
if RP.ConnectRX7('GB',1)
    e='connected'
else
    e='Unable to connect'
end

Visual Basic 'Connects to the RX7 via the Gigabit
If RP.ConnectRX7("GB",1) Then
    msgbox "Connection established"
Else
    msgbox "Error connecting to RX7"
End If
```

**Example:** Circuit Loader, page 72.

## ConnectRX8

**Description:** Establishes a connection with a Multi I/O Processor (RX8) through a device interface (such as Gigabit or USB).

**'C' Prototype:** `long ConnectRX8(LPCTSTR Interface, long DevNum);`

**Arguments:**

LPCTSTR	<i>Interface</i>	Interface to which the device is connected.
		<b>Argument    Connection    Part #s</b>

		'GB'	Gigabit	PI5/FI5, PO5/FO5
		'USB'	USB	UZ2, UB2, UZ1, UZ4
long	<i>DevNum</i>	Logical device number. Starts with 1 and counts up for each device of a specified type.		

**Returns:**

long	0	Connection not successful.
long	1	Connection successful.

**Note:** Invoke device connect commands only once to connect to a device, and then use ClearCOF and LoadCOF commands to upload or reload the control object to implement changes to the signal.

**Sample Code:**

```
MATLAB %Connects to RX8 #1 via Gigabit
RP=actxcontrol('RPco.x',[5 5 26 26]);
if RP.ConnectRX8('GB',1)
    e='connected'
else
    e='Unable to connect'
end
```

```
Visual Basic 'Connects to the RX8 via the Gigabit
If RP.ConnectRX8("GB",1) Then
    MsgBox "Connection established"
Else
    MsgBox "Error connecting to RX8"
End If
```

**Example:** Circuit Loader, page 72.

## ConnectRZ2

**Description:** Establishes a connection with a RZ2 Base Station through a device interface (such as Gigabit or Optibit).

**'C' Prototype:** `long ConnectRZ2(LPCTSTR Interface, long DevNum);`

**Arguments:**

LPCTSTR	<i>Interface</i>	Interface to which the device is connected.
		<b>Argument    Connection    Part #s</b>
		'GB'          Gigabit          PO5/Internal
long	<i>DevNum</i>	Logical device number. Starts with 1 and counts up for each device of a specified type.

**Returns:**

long	0	Connection not successful.
long	1	Connection successful.

**Note:** Invoke device connect commands only once to connect to a device, and then use ClearCOF and LoadCOF commands to upload or reload the control object to implement changes to the signal.

**Sample Code:**

```
MATLAB %Connects to RZ2 #1 via Gigabit
RP=actxcontrol('RPco.x',[5 5 26 26]);
if RP.ConnectRZ2('GB',1)
    e='connected'
```

```

else
    e='Unable to connect'
end
Visual Basic 'Connects to the RZ2 via the Gigabit
If RP.ConnectRZ2("GB",1) Then
    msgbox "Connection established"
Else
    msgbox "Error connecting to RZ2"
End If

```

**Example:** Circuit Loader, page 72.

## ConnectRZ5

**Description:** Establishes a connection with a RZ5 Base Station through a device interface (such as Gigabit or Optibit).

**'C' Prototype:** `long ConnectRZ5(LPCTSTR Interface, long DevNum);`

**Arguments:**

LPCTSTR	<i>Interface</i>	Interface to which the device is connected.
		<b>Argument Connection Part #s</b>
		'GB' Gigabit PO5/Internal
long	<i>DevNum</i>	Logical device number. Starts with 1 and counts up for each device of a specified type.

**Returns:**

long	0	Connection not successful.
long	1	Connection successful.

**Note:** Invoke device connect commands only once to connect to a device, and then use ClearCOF and LoadCOF commands to upload or reload the control object to implement changes to the signal.

**Sample Code:**

```

MATLAB %Connects to RZ5 #1 via Gigabit
RP=actxcontrol('RPco.x',[5 5 26 26]);
if RP.ConnectRZ5('GB',1)
    e='connected'
else
    e='Unable to connect'
end
Visual Basic 'Connects to the RZ5 via the Gigabit
If RP.ConnectRZ5("GB",1) Then
    msgbox "Connection established"
Else
    msgbox "Error connecting to RZ5"
End If

```

**Example:** Circuit Loader, page 72.

## ConnectRZ6

**Description:** Establishes a connection with a RZ6 Base Station through a device interface (such as Gigabit or Optibit).

**'C' Prototype:** `long ConnectRZ6(LPCTSTR Interface, long DevNum);`

**Arguments:**

LPCTSTR	<i>Interface</i>	Interface to which the device is connected.						
		<table> <thead> <tr> <th>Argument</th> <th>Connection</th> <th>Part #s</th> </tr> </thead> <tbody> <tr> <td>'GB'</td> <td>Gigabit</td> <td>PO5/Internal</td> </tr> </tbody> </table>	Argument	Connection	Part #s	'GB'	Gigabit	PO5/Internal
Argument	Connection	Part #s						
'GB'	Gigabit	PO5/Internal						
long	<i>DevNum</i>	Logical device number. Starts with 1 and counts up for each device of a specified type.						

**Returns:**

long	0	Connection not successful.
long	1	Connection successful.

**Note:** Invoke device connect commands only once to connect to a device, and then use ClearCOF and LoadCOF commands to upload or reload the control object to implement changes to the signal.

**Sample Code:**

```

MATLAB      %Connects to RZ6 #1 via Gigabit
            RP=actxcontrol('RPco.x',[5 5 26 26]);
            if RP.ConnectRZ6('GB',1)
               e='connected'
            else
               e='Unable to connect'
            end

Visual Basic  'Connects to the RZ6 via the Gigabit
            If RP.ConnectRZ6("GB",1) Then
               msgbox "Connection established"
            Else
               msgbox "Error connecting to RZ6"
            End If

```

**Example:** Circuit Loader, page 72.

# File and Program Control

## About the File and Program Control Methods

The file and program methods are used to load or clear a COF (Control Object File), run the device's processing chain, or halt the device's processing chain.

### File Methods

- [ClearCOF](#)
- [LoadCOF](#)
- [LoadCOFsF](#)
- [ReadCOF](#)

### Program Control Methods

- [Run](#)
- [Halt](#)

## ClearCOF

**Description:** Clears the program and data buffers on the processor.

**'C' Prototype:** `long ClearCOF;`

### Returns:

long	0	Not successful.
long	1	Successful.

### Sample Code:

**Description:** Clears the Control Object File (COF) and the data buffers on the processor device.

MATLAB `e1=RP.ClearCOF`

Visual Basic `error1 = RP.ClearCOF`

**Example:** Circuit Loader, page 72.

## LoadCOF

**Description:** Loads the Control Object File (\*.rco or \*.rcx) to the proper ActiveX control. This function/method is run after a Connectxx call and clears anything in the memory buffers on the processor device. See [ReadCOF](#) for information about establishing a connection between an ActiveX handle and a COF without clearing a device's memory buffers.

**Note:** LoadCOF loads the Control Object File in real time allowing programs to utilize multiple Control Object Files if needed.

**'C' Prototype:** `long LoadCOF(LPCTSTR FileName);`

### Arguments:

LPCTSTR `*.rco file or *.rcx` File name and extension

**Note:** the extension may be omitted for \*.rco files but must be specified for \*.rcx

**Returns:**

long 0 Not successful.  
long 1 Successful.

**Sample Code**

**Description:** Loads a Control Object File(COF) i.e. \*.rcx. and checks to see if it was properly loaded.

```
MATLAB
RP=actxcontrol('RPco.x',[5 5 26 26]);
RP.ConnectRP2('GB',1); % Connects to a RP2 via Gigabit
e=RP.LoadCOF('C:\Circuit.rcx'); % Loads circuit
if e==0
    disp 'Error loading circuit'
else
    disp 'Circuit ready to run'
end
```

```
Visual Basic
RP.ConnectRP2("GB",1)
If RP.LoadCOF("C:\Circuit.rcx") Then
    msgbox "File loaded and ready to run"
Else
    msgbox "Error loading *.rcx file to device"
```

**Example:** Circuit Loader, page 72.

**LoadCOFsf**

**Description:** Loads the Control Object File (\*.rco or \*.rcx) to the proper ActiveX control and sets the sampling frequency of the device. This function/method is run after a Connectxx call and clears anything in the memory buffers on the processor device. See [ReadCOF](#) for information about establishing a connection between an ActiveX handle and a COF without clearing a device's memory buffers.

**'C' Prototype:** long LoadCOFsf(LPCTSTR FileName, float Sample frequency);

**Arguments:**

LPCTSTR \*.rco file or \*.rcx File name and extension  
**Note:** the extension may be omitted for \*.rco files but must be specified for \*.rcx  
float Sample Frequency Values above 50 are used for arbitrary waveform generation.

0	1	2	3	4	5	6	>=50
6K	12K	25K	50K	100K	200K	400K	Arbitrary Sample rate
ALL	ALL	ALL	RP2 RP2.1 RL2 RV8 RX6 RX8	RP2 RP2.1 RL2 RV8 RX6 RX8	RP2 RP2.1 RV8 RX6 RZ6	RV8 RX6	RV8 RX6 RX8

			RZ2 RZ5 RZ6 D/A Only RA16BA RX5	RZ6 D/A Only RX5			
--	--	--	--	---------------------------	--	--	--

**TechNotes:** The sample frequencies are approximate and are subject to round-off error. Use [GetSFreq](#) to determine the actual sample rate.

Choosing a number greater than the maximum sample frequency for an RPx device will set that device to its maximum sample rate (for example: the maximum sample rate for an RL2 is 50 kHz (3) if the sample rate is set to 6 the devices sample rate will be 50 kHz).

PCM A/D and D/A equipped devices such as the RV8 and RX8 allow arbitrary rates to be specified. The PCM converters on these devices will adjust to the sampling rate specified without corrupting data. Sigma-Delta A/D and D/A equipped devices such as the RX6 and RX8 must specify supported realizable sampling rates in order to avoid data corruption. For more information on the realizable sampling rates supported by the Sigma-Delta converters, see [Realizable Sampling Rates for the RX6](#). RX8 devices equipped with Sigma-Delta converters should use the realizable sampling rates up to a maximum of 97.65625 kHz.

To use the arbitrary sample frequency on the RV8, RX6, or RX8 use a value greater than 50 for the sample frequency.

Setting the sample frequency for values greater than 6 and less than 50 will generate incorrect sample rates and the circuit will fail to run.

**Returns:**

long	0	Not successful.
long	1	Successful.

**Sample Code**

**Description:** Loads a Control Object File(COF), sets the sample rate to 200 kHz i.e. \*.rco, and checks to see if it was properly loaded. Also returns the true sample rate of the Device.

[MATLAB] In addition it loads the same COF file and sets the sampling rate to 200 Hz on an RV8

```

MATLAB
RP=actxcontrol('RPco.x',[5 5 26 26]);
% Connects to an RP2 via Gigabit
RP.ConnectRP2('GB',1);
% Loads circuit sets sample rate to 200 kHz
e=RP.LoadCOFs('C:\Circuit.rcx',5);
SFreq=RP.GetSFreq
if e==0
    disp 'Error loading circuit'
else
    disp 'Circuit ready to run'
end
RV8=actxcontrol('RPco.x',[5 5 26 26]);
RV8.ConnectRV8('GB',1);
e=RV8.LoadCOFs('C:\Circuit.rcx',200)
Visual Basic
RP.ConnectRP2("GB",1)
If RP.LoadCOFs("C:\Circuit.rcx",5) Then
    msgbox "File loaded and ready to run"
Else

```

```

        msgbox "Error loading *.rco file to processor
device"
End If
SFreq=RP.GetSFreq

```

## ReadCOF

**Description:** Reads the Control Object File (\*.rco or \*.rcx) to the proper ActiveX control. This function gives the ActiveX handle access to circuit components and parameters without reloading the circuit or clearing the memory buffers on the device. If the ReadCOF file is not the same as the circuit running on the device, the data will be erroneous. This function is primarily for use with portable or remote processor devices such as the stingray Pocket Processor.

**'C' Prototype:** `long ReadCOF(LPCTSTR FileName);`

**Arguments:**

LPCTSTR      *\*.rco or \*.rcx file*      File name (the extension does not need to be included).

**Returns:**

long	0	Not successful.
long	1	Successful.

**Sample Code**

**Description:** Reads a Control Object File(COF) i.e. \*.rco or \*.rcx.

MATLAB	<pre> RP=activexcontrol('RPco.x',[5 5 26 26]); % Connects to an RP2 via Gigabit RP.ConnectRL2('GB',1); % Reads circuit to ActiveX handle` e=RP.ReadCOF('C:\Circuit.rcx'); </pre>
Visual Basic	<pre> RP.ConnectRP2("GB",1) RP.ReadCOF("C:\Circuit.rcx") </pre>

## Run

**Description:** Starts the processor device processing chain. Run should be called after a Connect call and LoadCOF.

**'C' Prototype:** `long Run;`

**Arguments:** None.

**Returns:**

long	0	Not successful.
long	1	Successful.

**Sample Code**

**Description:** Goes through the connection, load and run procedure and checks to see if the circuit is running.

MATLAB	<pre> RP=activexcontrol('RPco.x',[5 5 26 26]); RP.ConnectRP2('GB',1) RP.LoadCOF('C:\Circuit.rcx'); e=RP.Run if e==0     disp 'error running circuit' </pre>
--------	---



```

else
    disp 'Circuit running'
end
Visual Basic error1 = RP.ConnectRP2("GB",1)
If error1 = 0 Then
    error1 = RP.ConnectRP2("USB", 1)
01If RP.LoadCOF("C:\Circuit.rcx") Then
    msgbox "File loaded"
Else
    msgbox "Error loading *.rcx file to device"
End If
If RP.Run Then
    msgbox "device circuit active and running"
Else
    msgbox "device circuit failed to run"
End If

```

**Example:** Circuit Loader, page 72.

## Halt

**Description:** Stops the processor device's processing chain.

**'C' Prototype:** `long Halt;`

**Returns:**

long	0	Not successful.
long	1	Successful.

**Sample Code**

**Description:** Stops the processor device's processing chain.

MATLAB	<code>e1 = RP.Halt</code>
Visual Basic	<code>error1 = RP.Halt</code>

## Device Status

### About the Device Status Methods

The device status methods return information to specific device characteristics such as the device's status, cycle usage, sampling frequency, number of total components in the COF file, and the names of any of the COF file components.

#### Device Status Methods

- [GetStatus](#)
- [GetCycUse](#)
- [GetSFreq](#)
- [GetNumOf](#)
- [GetNameOf](#)

### GetStatus

**Description:** Checks the status of the device and reports the state of various status indicators. A 0 or 1 is reported for each indicator and each indicator is reported as a single bit in a binary number. The binary number, including information about all possible indicators, is returned as an integer.

While each device type can have different status indicators, the first three bits return the same basic status information about the connection and circuit status on all devices. The return values in the table below are possible for the first three status bits on all devices. However, use bit-wise operations (0/1) instead of inspecting the integer value for best results.

Bitmasks remain constant while integer values change as new Bitmasks are added to GetStatus() in the future.

Integer	0	1	3	5	7
Binary	000	001	011	101	111
Status	Nothing	Connected	Connected and loaded	Connected and running	Connected, loaded, and running

**'C' Prototype:** `long GetStatus;`

**Arguments:** None

**Returns:** long

Return Value (Enabled)	Status	Bitmask	Bit#	Device
1	Connected	0000000000000001	0	All
2	Circuit loaded	0000000000000010	1	All
4	Circuit running	0000000000000100	2	All

8	Battery	000000000001000	3	RA16BA
16	Amplifier clipping on one or more channels	000000000010000	4	RA16BA
32	Amplifier clipped since last call to GetStatus	000000000100000	5	RA16BA
64	System Armed	000000001000000	6	RV8
128	Circuit running (not waiting for trigger)	000000010000000	7	RV8
256	Trigger enable	000000100000000	8	RV8
512	Auto Clear DAC outs	000001000000000	9	RV8
1024	Tick out	000010000000000	10	RV8
2048	Clock out	000100000000000	11	RV8
4096	zTrigA	001000000000000	12	RV8
8192	zTrigB	001000000000000	13	RV8
16384	External trigger	010000000000000	14	RV8
32768	Multiple trigger	100000000000000	15	RV8

**Note:** When checking the status of the Medusa Base Station (RA16BA), ensure that a preamplifier is properly connected and turned on. Connection status (Bit 0) will always return a 0 when a preamplifier is not properly connected. Bit 5 (amplifier clipped since last call) is reset after GetStatus is called.

Bit-0 does not report preamplifier status when using an RZ base station. Use the RZ LCD screen to determine PZ status.

**Sample Code**

**Description:** Checks if the circuit is loaded and running. Determines where in the loading routine the error occurred.

```
MATLAB
Status = double(RP.GetStatus); % Gets the status
% Checks for errors in starting circuit
if bitget(Status,1) == 0;
    er = 'Error connecting to RP'
elseif bitget(Status,2) == 0; % Checks for connection
    er = 'Error loading circuit'
elseif bitget(Status,3) == 0
    er = 'error running circuit'
else
    er = 'Circuit loaded and running'
end
```

```
Visual Basic
Status = RP.GetStatus
If (status And 7) = 7 Then MsgBox "System is running"
End If
```

**Example:** Circuit Loader, page 72.

## GetCycUse

**Description:** Checks the total cycle usage of a specified processor device. GetCycUse polls the processor device and returns an integer value between (0-100).

**Note:** If the value returned is greater than 100, the value will fold back within the 0-100 range (for example, a cycle usage of 130% would return a value of 30). To determine if cycle usage is too high, lower the sampling rate by a factor of 2. The cycle usage should be one-half the former value. (For example, if GetCycUse returns a value of 30, halving the sample rate should reduce the cycle usage to 15%. If, after halving the sample rate, the cycle usage is 65, you know that the original cycle usage was 130% not 30%.)

**'C' Prototype:** `long GetCycUse;`

**Arguments:** None.

**Returns:** long                      Percent cycle usage.

### Sample Code

**Description:** Warns if the cycle usage is over 90%.

```
MATLAB  if RP.GetCycUse < 90
         disp 'System within cycle usage limits'
        else
         disp 'Warning: reaching upper limits of cycle usage'
        end
```

```
Visual Basic  If RP.GetCycUse > 90 Then
              msgbox "Warning Cycle usage levels are to high"
            End If
```

**Example:** Device Checker, page 73.

## GetSFreq

**Description:** Returns the exact sampling frequency of the processor device.

**'C' Prototype:** `float GetSFreq;`

**Arguments:** None

**Returns:** float                      Sampling frequency.

### Sample Code

**Description:** Checks the sampling frequency and warns if a tone frequency is below the nyquist value of the circuit.

```
MATLAB  if ToneFreq > RP.GetSFreq/2
         disp 'Tone above Nyquist value'
        else
         disp 'Tone Freq below Nyquist'
        end
```

```
Visual Basic  If ToneFreq>RP.GetSFreq/2 Then
              msgbox "Warning: Tone frequency above nyquist value"
            End If
```

## GetNumOf

**Description:** Returns the number of components, parameter tags, parameter tables, or SrcFiles in a \*.rco file.

**'C' Prototype:** `long GetNumOf(LPCTSTR Name)`

**Arguments:**

LPCTSTR *Name* A string indicating the desired object type.

STRING Name	Component or Helper Type
"Component"	Number of processor device components
"ParTable"	Number of Parameter (Data) tables
"SrcFile"	Number of Source files (Data) files
"ParTag"	Number of Parameter Tags

**Returns:** long An integer equal to the number of objects of the specified type.

**Sample Code**

**Description:** Finds the number of Parameter Tags and returns their StringID

```
MATLAB TagNum = double(RP.GetNumOf('ParTag'))
for loop=1:TagNum
    TagName{loop} = RP.GetNameOf('ParTag', loop)
end
```

```
Visual Basic Dim TagNum As Integer
Dim TagName(100) As String*25
TagNum = RP.GetNumOf("ParTag")
For i = 1 to TagNum
    TagName(i)=RP.GetNameOf("ParTag", i)
Next i
```

**Example:** Device Checker, page 73.

**GetNameOf**

**Description:** Returns the name given to a particular parameter tag, component, data table, or source file in a processor device chain. The string 'NoName' will be returned if the object was not explicitly named in the RpvdsEx circuit. This function can be used in conjunction with [GetNumOf\(\)](#) to return a list of all parameter tags in an RCO file.

**'C' Prototype:** `CString GetNameOf(LPCTSTR Name, long Component_#)`

**Arguments:**

LPCTSTR *Name* A string indicating the desired object type.

STRING Name	Component Type
"Component"	processor components
"ParTable"	Parameter (Data) tables
"SrcFile"	Source (Data) files
"ParTag"	Parameter Tags

long            *Component\_#*            The number assigned to the component in the processing chain

**Returns:**

CString        String ID                    The String ID of the component

**Sample Code**

**Description:**    Finds the number of parameter tags and returns their source name.

```
MATLAB            TagNum=double(RP.GetNumOf('ParTag'))
                  for loop=1:TagNum
                      TagName{loop} = RP.GetNameOf('ParTag', loop)
                  end
```

```
Visual Basic      Dim TagNum As Integer
                  Dim TagName(100) As String*25
                  TagName=RP.GetNumOf("ParTag");
                  For i = 1 to TagNum
                      TagName(i) = RP.GetNameOf("ParTag", i)
                  Next i
```

**Example:**        Device Checker, page 73.

## Tag Status and Manipulation

### About the Tag Status and Manipulation Methods

The tag status and manipulation methods are used to read in values of the COF (Control Object File) file's tags or write values to the tags themselves.

**Tag Status Methods**

- [GetTagVal](#)
- [GetTagType](#)
- [GetTagSize](#)
- [ReadTag](#)
- [ReadTagV](#)
- [ReadTagVEX](#)

**Tag Manipulation Methods**

- [SetTagVal](#)
- [WriteTag](#)
- [WriteTagV](#)
- [WriteTagVEX](#)
- [ZeroTag](#)

### GetTagVal

**Description:**    Returns the value of a specified parameter tag. Because parameter tags point to a parameter input or output, GetTagVal provides a means of determining the

current value of a parameter. It can be used with all parameter types and returns a single floating point value.

**'C' Prototype:** `float GetTagVal(LPCTSTR Name)`

**Arguments:**

LPCTSTR      *Name*                      A string variable that matches exactly the name of a parameter tag.

**Returns:**

float              current value of tag      The numerical type of the parameter does not affect the return variable.

**Sample Code**

**Description:** Reads value of tag labeled 'RMS' and saves it to the variable rms.

```
MATLAB      rms = RP.GetTagVal('RMS'); % Reads rms level
Visual Basic      Dim rms As single
                 rms = RP.GetTagVal("RMS") 'Reads rms level
Visual C++      float rms;
                 rms = RP.GetTagVal("RMS"); //Reads rms level
```

**Examples:** Variable Band-Pass filter, page 74.  
 Continuous Play, page 79.  
 Continuous Acquire, page 76.  
 Two Channel Continuous Acquisition, page 83.

**GetTagType**

**Description:** Determines the data type of a parameter tag.

**'C' Prototype:** `long GetTagType(LPCTSTR Name)`

**Arguments:**

LPCTSTR      *Name*                      The name of a parameter tag.

**Returns:**

MATLAB      long                                  An Integer that maps to an ASCII character.

<b>Data Type</b>	<b>Integer Value</b>
Data Buffer	68
Integer	73
Logical (1 or 0)	78
Float(Single)	83
Coefficient Buffer	80
Undefined (e.g. latch output)	65

Visual Basic      char                                  An ASCII character.

<b>Data Type</b>	<b>Ascii Map</b>
Data Buffer	"D"
Integer	"I"
Logical (1 or 0)	"L"
Float(Single)	"S"

Coefficient Buffer	"P"
Undefined (e.g. latch output)	"A"

**Sample Code**

**Description:** Finds the data type of a particular parameter tag.

MATLAB `DataType = char(RP.GetTagType('RAMBuffer'));`  
 Visual Basic `DataType = char(RP.GetTagType("RamBuffer"))`

**Example:** Device Checker, page 73.

**GetTagSize**

**Description:** Returns the maximum number of data points accessible through the parameter tag.

**'C' Prototype:** `long GetTagSize(LPCTSTR Name)`

**Arguments:**

LPCTSTR *Name* A string variable that matches the name of a parameter tag.

**Returns:** long 0= error, 1=Logic, Integer, Float (Single),>1 Data type (Pointer to a buffer).

**Sample Code**

**Description:** Returns the number of points in the ram buffer.

MATLAB `Tagsize = RP.GetTagSize('RAMBuffer');`  
 Visual Basic `Dim DataType As Integer`  
`DataType = RP.GetTagSize("RamBuffer")`

**Example:** Device Checker, page 73.

**ReadTag**

**Description:** Reads data from the processor device's memory into variables stored on the PC. [ReadTagV](#) should be used with MATLAB. Other programming languages should use ReadTag. See [ReadTagVEX](#) for alternative ways to read data.

ReadTag can be used with any component that has a data buffer, such as: RamBuffer, LongDynDel, FIR and so forth.

**'C' Prototype:** `long ReadTag(LPCTSTR Name, float* pBuf, long nOS, long nWords);`

**Arguments:**

LPCTSTR *Name* Name of parameter tag.

float\* *pBuf* Pointer to buffer to receive data.

long *nOS* Number of points to offset in buffer before starting read.

long *nWords* Number of 32-bit words to read (Samples).

**Returns:**

long 0 Not successful.

long 1 Successful.

**Sample Code**



**Description:** Reads 1000 points from a buffer (parameter tag labeled "datain") and stores it in a single array file (data).

Visual Basic 6 `Dim data(0 to 999) As single  
e1=RP.ReadTag("datain", data(0),0,1000)`

**Description:** Reads 1000 points from parameter tag labeled 'datain' to floating point array called data.

Visual C++ `float data[1000];  
char Name[10];  
Name = "datain";  
ReadTag(Name, data, 0, 1000);`

## ReadTagV

**Description:** Reads variables stored in the processor device's memory into a PC buffer in variant format. ReadTagV should be used with MATLAB. Other programming languages should use [ReadTag](#). See [ReadTagVEX](#) for alternative storage methods.

ReadTagV can be used with any component that has a data buffer, such as: RamBuffer, LongDynDel, FIR and so forth.

**'C' Prototype:** `VARIANT ReadTagV(LPCTSTR Name, long nOS, long nWords);`

### Arguments:

LPCTSTR	<i>Name</i>	Name of parameter tag.
long	<i>nOS</i>	Number of points to offset in buffer before starting read.
long	<i>nWords</i>	Number of 32-bit words to read (Samples).

### Returns:

Variant	-1, or empty	Not successful.
Variant	Array	Successful.

### Sample Code

**Description:** Reads 1000 points from a buffer (parameter tag 'datain') and stores it in an array file (Data\_A) as variant values.

MATLAB `Data_A = RP.ReadTagV('datain',0,1000);`

**Example:** Continuous Acquire, page 76.

## ReadTagVEX

**Description:** Reads data that has been written to a parameter tag and stored on the processor device. Data can be converted to one of five data formats (double, float, 32-, 16-, 8-bit Integer) and stored as either an array or a matrix. The user must specify the storage format of the data to be read (F32, 32-, 16-, or 8-bit Integer) and the number of channels.

When used to read compressed or shuffled data ReadTagVEX handles data manipulation and storage. Shuffled data is separated into channels and stored in a matrix. The *nWords* argument must be set to the number of samples in the serial buffer and is used along with *nchannels* to unshuffle or expand the data. For compressed data *nWords* must be set to the number of points after compression. e.g. If the data is compressed two-folded then only 500 samples of

a 1000 point signal are contained in the serial buffer and *nWords* should be set to 500 (for a compression of 4 the number of points in the buffer would be 250).

ReadTagVEX is used with components that have a data Buffer, including: RamBuffer, Serial Buffer, Average Buffer, LongDelay, LongDynDelay, ShortDelay, ShortDynDelay, Biquad, IIR, FIR, HrtfFir.

**Note:** ReadTagVEX and WriteTagVEX are the only read/write commands that will work in languages other than MATLAB, VB6, and VC++

**'C' Prototype:** `VARIANT ReadTagVEX(LPCTSTR Name, long nOS, long nWords, LPCTSTR stype, LPCTSTR dtype, long nchannels);`

**Arguments:**

LPCTSTR *Name* Name of parameter tag.  
 long *nOS* Number of points to offset in buffer before starting read.  
 long *nWords* Number of 32-bit words to read (Samples).  
 LPCTSTR *Srctype* Format type of data being read. Below is a list of the storage types.

Floating Point (32-bit)	Word (32-bit)	Integer (16-bit)	Byte (8-bit)
F32	I32	I16	I8

LPCTSTR *Dstype* Format for storing data. MATLAB handles data as doubles. All other languages use a variety of formats.

Double(64-bit float)	Float (32-bit)	Word (32-bit)	Integer(16-bit)	Byte(8-bit)
F64	F32	I32	I16	I8

long *nchannels* Number of data channels (1-4). For compressed and standard it is 1. For Shuffled data it is 2 or 4.

**Returns:**

Variant -1, or empty Not successful.  
 Variant Array Successful.

**Sample Code**

**MATLAB**

**Description:** Reads 1000 points from a processor device buffer (either compressed or Standard format) and stores it in an array of 1000 points in double format.  
`Data_A=RP.ReadTagVEX('datain',0,1000,'I16','F64',1);`

**Description:** Reads 2000 points from a processor device buffer that contains a shuffled data set (2-channels) and stores it in a matrix (2,1000) in double format.  
`Data_A=RP.ReadTagVEX('datain',0,2000,'I16','F64',2);`

**Visual Basic**

**Description:** Reads 1000 points from a processor device buffer and stores it in an array of 1000 points in 16-bit Integer format.  
`Data_A=RP.ReadTagVEX("datain",0,1000,"I16","I16",1)`

**Description:** Reads 1000 points from a processor device buffer that contains a shuffled data set (2-channels) and stores it in a matrix (2,1000) in 16-bit integer format.

`Data_A=RP.ReadTagVEX("datain",0,1000,"I16","I16",2)`

**Example:** Two Channel Continuous Acquisition, page 83.

## SetTagVal

**Description:** Sets the value of the specified parameter tag.

**'C' Prototype:** `long SetTagVal(LPCTSTR Name, float Val)`

**Arguments:**

LPCTSTR	<i>Name</i>	Name of a parameter tag.
float	<i>Val</i>	Parameter tag value.

**Returns:**

long	0	Not successful.
long	1	Successful.

**Sample Code**

**Description:** Sets the parameter Tag value to that of the variable "rms".

MATLAB	<code>rms=5.0</code> <code>e1=RP.SetTagVal('RMS', rms); % Set RMS Level</code>
Visual Basic	<code>rms=5.0</code> <code>e1=RP.SetTagVal("RMS", rms) 'Set RMS Level</code>
Visual C++	<code>float rms=5.0;</code> <code>RP.SetTagVal("RMS", rms); //Set RMS Level</code>

**Example:** Band-Limited Noise, page 74.

## WriteTag

**Description:** Writes data from the PC to a memory buffer pointed to by a parameter tag. [WriteTagV](#) should be used with MATLAB. Other programming languages should use WriteTag. See [WriteTagVEX](#) for alternative methods of writing data.

WriteTag is used with the following components that have a data Buffer: RamBuffer, Serial Buffer, Average Buffer, LongDelay, LongDynDelay, ShortDelay, ShortDynDelay, Biquad, IIR,FIR, HrtfFir.

**'C' Prototype:** `long WriteTag(LPCTSTR Name, float* pBuf, long nOS, long nWords);`

**Arguments:**

LPCTSTR	<i>Name</i>	Name of parameter tag.
float*	<i>pBuf</i>	Floating point array holding data to load to the processor device's memory.
long	<i>nOS</i>	Number of points to offset in the processor device's memory before starting write.
long	<i>nWords</i>	Number of 32-bit words to write.

**Returns:**

long	0	Not successful.
long	1	Successful.

**Sample Code**

**Description:** Writes 1000 points from an array named 'data' to a memory buffer on the processor device (parameter tag labeled 'datain').

```
Visual Basic 6 Dim data(0 to 999) As single
                el=RP.WriteTag("datain", data(0), 0, 1000)
Visual C++     float data[1000];
                char Name[10];
                Name = "datain"; // fill data array with data to load
                RP.WriteTag(Name, data, 0, 1000);
```

**WriteTagV**

**Description:** Writes variables from the PC to a memory buffer on the processor device. WriteTagV should be used with MATLAB. Other programming languages should use [WriteTag](#). WriteTagV is designed to take data in a standard MATLAB row vector. Column vectors should be transposed.

WriteTagV is used with the following components that have a data Buffer: RamBuffer, Serial Buffer, Average Buffer, LongDelay, LongDynDelay, ShortDelay, ShortDynDelay, Biquad, IIR,FIR, HrtfFir.

**Note:** WriteTagV is to be used in Matlab *only* with data type double. Attempting to write vectors of any other type will fail and return a zero.

See [WriteTagVEX](#) for alternative methods of writing vectors of all other data types.

**'C' Prototype:** `long WriteTagV(LPCTSTR Name, long nOS, Variant &buffer);`

**Arguments:**

LPCTSTR	<i>Name</i>	Name of parameter tag.
long	<i>nOS</i>	Number of points to offset in buffer before starting write.
Variant	<i>&amp;buffer</i>	Data array with the samples.

**Returns:**

long	0	Not successful.
long	1	Successful.

**Sample Code****MATLAB**

**Description:** Writes 10000 points from an array (data) to a memory buffer on a processor device (pointed to by the parameter tag (datain)).

```
e1=RP.WriteTagV('datain', 0, data(1000:11000));
```

**Description:** Writes 1000 points from an array (data) to a memory buffer on a processor device (pointed to by the parameter tag (datain)).

```
e1=RP.WriteTagV('datain', 0, data(0:1000));
```

**Example:** Continuous Play, page 79.

## WriteTagVEX

**Description:** WriteTagVEX writes data stored in array or matrix format to a memory buffer on the processor device. The data format for storage in the memory buffer can be one of the following: 32-bit Float, 32-,16-, and 8-bit Integer formats. In addition, data is not limited to a single array format. The organization of variables stored in a matrix is preserved.

WriteTagVEX is used with the following components that have a data Buffer: RamBuffer, Serial Buffer, Average Buffer, LongDelay, LongDynDelay, ShortDelay, ShortDynDelay, Biquad, IIR, FIR, and HrtfFir.

**Note:** ReadTagVEX and WriteTagVEX are the only read/write commands that will work in languages other than MATLAB, VB6, and VC++

**'C' Prototype:** `long WriteTagVEX(LPCTSTR Name, long nOS, LPCTSTR dtype, Variant &buffer);`

**Arguments:**

LPCTSTR	<i>Name</i>	Name of parameter tag.
long	<i>nOS</i>	Number of points to offset in buffer before starting write.
LPCTSTR	<i>dtype</i>	One of four data types that the data is stored in.

Floating Point(32-bit)	Word(32-bit)	Integer(16-bit)	Byte(8-bit)
F32	I32	I16	I8

Variant	<i>&amp;buffer</i>	Data array/matrix with the samples.
---------	--------------------	-------------------------------------

**Returns:**

long	0	Not successful.
long	1	Successful.

**Sample Code**

**MATLAB**

**Description:** Writes 10000 points from an array to a memory buffer on a processor device in floating point format.

```
e1=RP.WriteTagVEX('datain', 0, 'F32', data(1000:11000));
```

**Description:** Writes 2000 points from a matrix (data) to a memory buffer on the processor device (pointed to by the parameter tag (datain) in integer format (16-bit).

```
e1=RP.WriteTagVEX('datain', 0, 'I16', data(1:2,1:1000));
```

**Visual Basic**

**Description:** Writes 2000 points from a matrix (data) into a data buffer on a processor device (pointed to by parameter tag datain).

```
Dim data(1 to 2,0 to 999) As Variant
e1=RP.WriteTagVEX("datain", 0, "I16", data)
```

**Description:** Writes a 1000 points from an array as float variables to a data buffer on a processor device.

```
Dim data(0 to 999) As Variant
e1=RP.WriteTagVEX("datain", 0, "F32", data)
```

**Example:** Two-channel Playback, page 85.

## ZeroTag

**Description:** Sets a parameter tag value to zero. When the parameter tag points to a memory buffer, all values in the buffer are set to zero.

**'C' Prototype:** `long ZeroTag(LPCTSTR Name);`

**Arguments:**

LPCTSTR	<i>Name</i>	Name of parameter tag.
---------	-------------	------------------------

**Returns:**

long	0	Not successful.
long	1	Successful.

**Sample Code**

**Description:** Sets membuf values to zero.

MATLAB	<code>error1=RP.ZeroTag('membuf');</code>
Visual Basic	<code>error1=RP.ZeroTag("membuf");</code>

## Other

### GetDevCfg

**Description:** GetDevCfg is used with the RV8. After setting the number of sweeps with SetDevCfg, you can use this function to determine the number of sweeps remaining on the RV8. At this time, only the information pertaining to the remaining sweeps can be retrieved from the device.

**'C' Prototype:** `long GetDevCfg(long Address, long Wide32)`

**Arguments:**

long	<i>address</i>	Position of a particular data value.
	<b>Address</b>	<b>Configuration information</b>
	9	Sweep Count
long	<i>Wide32</i>	Set Wide32 = 0

**Returns:** long The value at the memory location.

**Sample Code**

**Description:** Finds the number of sweeps left on the RV8.

MATLAB	<code>Sweeps_Left = RP.GetDevCfg(9, 0);</code>
Visual Basic	<code>Sweeps_left = RP.GetDevCfg(9, 0)</code>

### SetDevCfg

**Description:** SetDevCfg is used with the RV8. It allows direct access to memory locations for the control of the RV8 special modes, sample number, trigger counter and bit logic.

**'C' Prototype:** `long SetDevCfg(long Address, long Value, long Wide32)`

**Arguments:**

- long *address* Position of a device configuration value.
- long *value* Sets the value of the device.
- long *Wide32* Setting Wide32=1 enables modification of the upper and lower registers of the sample counter simultaneously.

**Returns:**

- long 1 Successful.
- long 0 Not successful.

**Tech Notes:**

**Address Configuration information**

0 Special Mode value for the RV8. The bitmask for the special mode is as follows: The top row is the bit number, the middle row contains the integer value for setting the bit number, and the bottom row describes the Configuration property.

0	1	2	3	4	5	6	7
1	2	4	8	16	32	64	128
Trigger Enabled	AutoClr DACs	Tick Out	Clk Out	UseZtrigA	UseZTrigB	Ext Trig	Multiple Trigger

- 1 Integer value allows user to set sample rate. Make sure the RV8 is halted before using.
- 2 CountLo. The Lower 16-bits of the Sample Counter. Note use Wide32 to write to the upper and lower counter simultaneously.
- 3 CountHi. The Upper 16-bits of the Sample Counter. See Note above
- 09 Sweep Count. Sets the number of times the RV8 can be triggered in mTrig mode.
- 0a/10 OutLogic: Sets the value for a logical high. The default value for each output channel is 0 (logical high = 1 or 'high true'). Setting OutLogic = 1 inverts the logic (logical high = 0 or 'low true').
- 0b/11 InLogic: Sets the value for a logical high. See OutLogic for a description.

**Enabling the Trigger Mode**

The Trigger mode requires that you set two components of the Special Mode: Bitmask 1 and one of the Three trigger types (zBUSA, zBUSB or External). Note only one of the three trigger types (zBUSA, zBUSB or External) can be enabled at any time. Additional modes that might be enabled are multiple trigger and AutoClr.

Multiple trigger allows users to trigger the RV8 with out halting and running the chain again. In addition It allows users to set the maximum number of times a system can be triggered. To set the Multiple Trigger requires that you also set the Sweep Count. Sweep Count can be set to any value between 1 and 4,294,967,296.

AutoClr: AutoClr sets the DAC outs to 0. If AutoClr is not set the last value sent to the DAC's is played out.

**Setting the Sample Count**

In the Trigger mode the sample count needs to be a value greater than zero otherwise the signal will play for a long time. There are two ways to set the Sample Count. The Lower and Upper Count addresses can be set separately or by setting wide32=1 in the SetDevCfg it allows users to

set the value for both upper and lower addresses. TDT recommends that `wide32` be used to set the value. The example below shows the difference.

Setting the Sample Count for 300,000 with `wide32`. In this case it is a matter of using the actual value.

```
RV8.SetDevCfg(2,300000,1)
```

Setting the Sample Count for 300,000 without `wide32`.

300,000 needs to be converted to a hexadecimal value and then split into the lower and upper 16-bit values. In this case the lower 16-bit value is 37,856. The Upper 16-bit value is 4.

```
RV8.SetDevCfg(2,37856,0)
RV8.SetDevCfg(3,4,0)
```

### Setting Multiple Triggering

In Single Trigger mode the circuit needs to be halted and run after each trigger. In Multiple trigger mode the circuit can be configured to be triggered several times before the circuit needs to be halted. The code below sets the circuit to trigger 5 times before it needs to be reset. The maximum number of times a circuit can be triggered is by setting this variable is 65535. If sweep count is set to 0 (default) the circuit will trigger a near infinite number of times.

```
RV8.SetDevCfg(09,5,0)
```

### Using the zTRIG Option

To use the `zTRIGB` or `UsezTRIGA` option you need to use the `zBUS` ActiveX controls. Your code should include a connection to the [zBUS](#). The example code below shows how this would work. Make sure that the ActiveX control is active in your program. Note it is not necessary to have a Trigger component in the circuit.

```
MATLAB      zBUS.ConnectZBUS('GB')
            RV8.ConnectRV8('GB',1)
            RV8.LoadCOF('C:\Circuit.rcx')
            %Triggers off zBUSA, AutoClr, and multiple trigger
            RV8.SetDevCfg(0,147,0)
            RV8.SetDevCfg(2,30000,1) %Plays out 30000 samples
            %Triggers up to 10 times before stopping
            RV8.SetDevCfg(9,10,1)
            RV8.Run
            zBUS.zBUStrigA(0,0,10) %Triggers the RV8
            %Returns the number of sweeps left
            sweepcount=RV8.GetDevCfg(9,0)
```

## SoftTrg

**Description:** Sends a software trigger to the processor device. There are ten software triggers for each processor device.

**Note:** Do not use software triggers for signal generation or acquisition that requires precise timing. Software triggers are affected by USB transfer times. Expect a 2-4 ms delay for each call to the processor device from the `SoftTrg()`. If multiple devices need to be triggered simultaneously use `zBusTrigA/B()`.

**'C' Prototype:** `long SoftTrg(long Trg_Bitn);`

### Arguments:

long	<i>Trg_Bitn</i>	Software trigger number to send.
------	-----------------	----------------------------------

### Returns:

long	0	Not successful.
long	1	Successful.



**Sample Code**

MATLAB

**Description:** This starts one of ten possible software triggers.

```
error1=RP.run
error2=RP.SoftTrg(1)
```

Visual Basic

**Description:** This starts one of ten possible software triggers. It then starts another software trigger.

```
error1=RP.run
error2=RP.SoftTrg(1)
error3=RP.SoftTrg(10)
```

**Examples:** Continuous Play, page 79.  
 Continuous Acquire, page 76.  
 Two Channel Continuous Acquire, page 83.

**SendParTable**

**Description:** Sends data from a DataTable to its output.

**'C' Prototype:** `long SendParTable(LPCTSTR Name, float IndexID);`

**Arguments:**

LPCTSTR	<i>Name</i>	Name of DataTable component (not a parameter tag).
float	<i>IndexID</i>	ID number of column of data to send.

**Returns:**

long	0	Not successful.
long	1	Successful.

**Sample Code**

**Description:** Cycles through three filters for the same input. Allows changes in the filter coefficients from a data table.

MATLAB

```
for n = 1:3
    e1 = RP.SendParTable('PTab', n);
    if e1==0
        disp 'Filter incorrectly loaded'
    else
        disp ['Filter' num2str(n) ' loaded']
    end
end
```

Visual Basic

```
For n = 1 To 3
    e1 = RP2.SendParTable("PTab", n)
    If e1 = 0 Then
        MsgBox "Filter incorrectly loaded"
    Else
        MsgBox "Filter " & n & " loaded"
    End If
End For
```

**Example:** FIR filtered noise, page 81.

## SendSrcFile

**Description:** Sends data from a data file (specified in a SourceFile Component) into the processing chain. This allows programmers to load a data file from the PC directly to a RAM buffer.

**Tech Notes:** SourceFile supports the following data types: Float Point (32-bit), Long Int(32 bit), Int (16-bit), Ascii, and Wav formats.

SendSrcFile gives you control over the size of data transferred and the position in the data file that SendSrcFile starts. A file can contain many waveforms that are played at different times or in different circumstances.

16-bit words are padded to fit the 32-bit format of the Data Buffers.

Note that this method does not let you specify a new filename to load. This can only be done in the RPvds circuit. If you need to load data from different files, you would first load it into a PC buffer and then use [WriteTag\(\)](#) to send the data to a buffer on the processor device.

**'C' Prototype:** `long SendSrcFile(LPCTSTR Name, long SeekOS, long nWords)`

### Arguments:

LPCTSTR	<i>Name</i>	Name of DataFile Component in RPvdsEx circuit (not a parameter tag).
long	<i>SeekOS</i>	Position in the Data file to start writing to the buffer.
long	<i>nWords</i>	Number of 32-bit words to send.

### Returns:

long	0	Not successful.
long	1	Successful.

### Sample Code

**Description:** This code finds the number of SrcFiles, gets the String ID of the last SrcFile and sends a portion of the PC data file to the processor device.

```
MATLAB
SrcFile1=RP.GetNumof('SrcFile')
SFile=RP.GetNameOf('SrcFile', SrcFile1)
test=RP.SendSrcFile(SFile, 1000, 50000);

Visual Basic
SrcFile1=RP.GetNumof("SrcFile")
SFile=RP.GetNameOf("SrcFile", SrcFile1)
test=RP.SendSrcFile(SFile, 1000, 50000);
```

# PA5 Programmable Attenuator

## About the PA5x Methods

This section provides a listing of the available PA5x ActiveX control methods.

### Programming Steps

- Add the PA5x ActiveX controller to your program. The ActiveX help has examples for setting up ActiveX controllers in MATLAB, Visual Basic, and Visual C.
- Connect to a PA5 (USB or GB) device with the connectPA5 function.
- Control the PA5 with the command and control functions using the ActiveX controller.

### ConnectPA5

**Description:** Establishes a connection with the specified device. The connection is established through either the Gigabit or USB interface. Invoking this method causes the control to search for the specified device and establish a handle to the associated device driver. The method will return a '1' if a connection was successfully established or a '0' if the device is not present or if it is not functioning properly.

**'C' Prototype:** `Long ConnectPA5(LPCTSTR Interface, long DevNum);`

#### Arguments:

LPCTSTR	<i>Interface</i>	Interface to which the device is connected.
		<b>Argument</b> <b>Connection</b> <b>Part #s</b>
		'GB'            Gigabit            PI5/FI5
		'USB'          USB                UZ2, UB2, UZ1, UZ4
long	<i>DevNum</i>	Logical device number. Starts with 1 and counts upward for each device of a specified type.

#### Returns:

long	0	Connection not successful.
long	1	Connection successful.

#### Sample Code

##### MATLAB

**Description:** Connects to PA5#1 via Gigabit

```
% Connects to PA5 #1 via Gigabit
PA5x1=activexcontrol('PA5.x',[5 5 26 26]);
if PA5x1.ConnectPA5('GB',1)==1
    e= 'connected'
else
    e= 'Unable to connect'
end
```

##### Visual Basic

**Description:** Connects to PA5 #2 via Gigabit

```
If PA5x1.ConnectPA5("GB", 2) Then
```

```

    MsgBox "Connection established"
Else
    MsgBox "Unable to connect"
End If

```

## Display

**Description:** Prints text to the PA5's LED display.

**'C' Prototype:** `BOOL Display(LPCTSTR Text, long Position);`

### Arguments:

LPCTSTR	<i>Text</i>	String to be printed to the display (max length eight characters).
long	<i>Position</i>	Position in display: 0=left, 7=right.

### Returns:

Boolean	False (0)	Not successful.
Boolean	True (-1)	Successful.

### Sample Code

**Description:** Displays a warning.

MATLAB	<code>PA5x1.Display('Check Attenuation', 0);</code>
Visual Basic	<code>PA5x1.Display("Check Attenuation", 0)</code>

## GetError

**Description:** Use this call to retrieve an error message or to test for an error. Returns a string containing one of the following error messages:

zBus Error: - This shows where the error occurred

Call:PA5setatt - What function call was attempted

zError:One or more arguments out of range. - Error message

**'C' Prototype:** `CString GetError;`

### Returns:

CString	error	Error message.
---------	-------	----------------

### Sample Code

**Description:** Checks for an error message and displays it on the PA5 if one is returned.

MATLAB	<code>ErrMess = PA5x1.GetError if length(ErrMess) &gt; 0     disp ErrMess end</code>
Visual Basic	<code>Dim ErrMess As String ErrMess = PA5x1.GetError If Len(ErrMess) &gt; 0 Then     MsgBox ErrMess End If</code>

## GetAtten

**Description:** Returns the current level of attenuation on the PA5 as a value from 0-120. It is not altered by user-defined attenuation levels.

**'C' Prototype:** `float GetAtten;`

**Returns:**

float                   attenuation on PA5

**Sample Code**

MATLAB

**Description:** Starts an active X control for the PA5, connects to PA5 #1 through the GB port and gets the current attenuation setting for the PA5.

```
PA5x1=activexcontrol('PA5.x',[5 5 26 26])
PA5x1.ConnectPA5('GB', 1) % Connects PA5 via Gigabit
z=PA5x1.GetAtten
```

Visual Basic

**Description:** Connects PA5 #1 through the GB and gets the current attenuation setting.

```
PA5x1.ConnectPA5("GB", 1)
z=PA5x1.GetAtten
```

## Reset

**Description:** Resets the PA5 and restores the factory defaults.

Factory defaults are:

Attenuation=0.0, Step size =3.0, Update=Dynamic.

**'C' Prototype:** `BOOL Reset;`

**Arguments:** None

**Returns:**

Boolean           False (0)                   Not successful.

Boolean           True (-1)                   Successful.

**Sample Code**

**Description:** Starts ActiveX control, connects to the PA5 via the GB interface, and resets the PA5 to the factory defaults (0.0 attenuation).

```
MATLAB PA5x1=activexcontrol('PA5.x',[5 5 26 26])
PA5x1.ConnectPA5('GB', 1) % Connects PA5 via Gigabit
PA5x1.Reset
```

```
Visual Basic PA5x1.ConnectPA5("GB",1)
PA5x1.Reset
```

## SetAtten

**Description:** Sets attenuation on the PA5. Attenuation is a floating point value between 0.0 and 120. Values higher and lower than these values will set an error flag. You can use [GetError\(\)](#) to check for error messages.

**'C' Prototype:** `BOOL SetAtten(float AttVal);`

**Arguments:**

float            *AttVal*            Attenuation (0.0...120.0).

**Returns:**

Boolean        False (0)            Not successful.  
                  True (-1)            Successful.

**Sample Code**

**Description:** Sets the Attenuation to the value given by "Atten" and checks for an error. If "Atten" is greater than 120 or less than zero an error message is generated.

```
MATLAB
PA5x1.SetAtten(Atten);
error1=PA5x1.GetError();
if length(error1)==0
    disp 'Attenuation set correctly'
else
    PA5x1.Display(error1, 0)
end

Visual Basic
PA5x1.SetAtten(Atten)
error1 = PA5x1.GetError
If error1 = "" Then
    msgbox "Attenuation set correctly"
Else
    msgbox error1
End If
```

**SetUser**

**Description:** Sets parameters for User Attenuation mode. For a complete description of how these work, check the TDT online help. A brief description of each function is given below along with an ActiveX example.

**Note:** User values are used for comparison and display purposes only. They do not affect the values for [SetAtten\(\)](#) or [GetAtten\(\)](#). They should only be used to quickly assess signals from several PA5's using the front panel display.

**'C' Prototype:** `BOOL SetUser(long ParCode, float Val);`

**Arguments:**

long            *ParCode*            Code for specific parameter.

ParCode	Parameter Constants (Name)
1	PA5_USERPAR_BASE: Set base attenuation (0.0 .. 120.0 dB). Base attenuation is used when several stimulus devices (speakers) vary in signal intensity. Setting the base for each speaker will display the same attenuations.
2	PA5_USERPAR_STEP: Set dB step size (0.0 .. 120.0 dB)
3	PA5_USERPAR_REFERENCE: Set Reference dB Level (0.0 .. 120.0 dB). Reference attenuation allows the user to display smaller numbers (including negative ones). For example, for a Reference of 120 the most intense signal would display 120 dB on the front panel and the least intense signal would display 0.0 under user settings.

4	PA5_USERPAR_UPDATE: Sets User Update Parameter. DYNAMIC updates produce a continuous change in attenuation. MANUAL update only changes the attenuation when the Select button (dial) is pressed. The display is dimmed while changing the attenuation. Use PA5_USERUPDATE_DYNAMIC or PA5_USERUPDATE_MANUAL for Val argument.	
	0	PA5_USERUPDATE_DYNAMIC Set User Update mode to Dynamic, where attenuation is changed as the dial is turned.
	1	PA5_USERUPDATE_MANUAL Set User Update mode to Manual, where attenuation is not changed while dial is turned. Attenuation updates only when the user presses the dial to SELECT the new value.
5	PA5_USERPAR_ABSMIN: Set minimum level of attenuation allowed on the PA5. Used to prevent accidental output of very loud sounds.	

float *Val* Value for given parameter code.  
**Returns:** 0 Not successful.  
 -1 Successful.

**Sample Code**

**Description:** Sets up a series of constants that match the values used for 'SetUser'. Some parameter values for the different User functions are set. Finally the code sends all of the variables to the PA5. The user is given 5 seconds to change the setting and see the difference between the value that the userAtten displays and the base value for the attenuator.

```
MATLAB
PA5x1=actxcontrol('PA5.x',[5 5 26 26]);
PA5x1.ConnectPA5('GB', 1) % Connects PA5 via Gigabit
% Constants used by Setuser
PA5_USERPAR_BASE=1;
PA5_USERPAR_STEP=2;
PA5_USERPAR_REFERENCE=3;
PA5_USERPAR_UPDATE=4;
PA5_USERUPDATE_DYNAMIC=0;
PA5_USERUPDATE_MANUAL=1;
PA5_USERPAR_ABSMIN=5;
% Parameter values used for Setuser
Base=5;
Step=5;
Reference=120;
Absmin=20.0;
% Invoke commands for SetUser
PA5x1.SetUser(PA5_USERPAR_BASE, Base);
PA5x1.SetUser(PA5_USERPAR_STEP, Step);
PA5x1.SetUser(PA5_USERPAR_REFERENCE, Reference);
PA5x1.SetUser(PA5_USERPAR_ABSMIN, Absmin);
PA5x1.SetUser(PA5_USERPAR_UPDATE, PA5_USERUPDATE_DYNAMIC);
pause(1)
% Check the values
PA5x1.GetAtten

Visual Basic
'Constants used by Setuser
const PA5_USERPAR_BASE=1
const PA5_USERPAR_STEP=2
```

```
const PA5_USERPAR_REFERENCE=3
const PA5_USERPAR_UPDATE=4
const PA5_USERUPDATE_DYNAMIC=0
const PA5_USERUPDATE_MANUAL=1
const PA5_USERPAR_ABSMIN=5
'Parameter values used for Setuser
Base=5
Step=5
Reference=120
Absmin=20.0
PA5x1.ConnectPA5("GB", 1) 'Connects PA5x1 via Gigabit
'Invoke commands for SetUser
PA5x1.SetUser(PA5_USERPAR_BASE, Base)
PA5x1.SetUser(PA5_USERPAR_STEP, Step)
PA5x1.SetUser(PA5_USERPAR_REFERENCE, Reference)
PA5x1.SetUser(PA5_USERPAR_ABSMIN, Absmin)
PA5x1.SetUser(PA5_USERPAR_UPDATE, PA5_USERUPDATE_DYNAMIC);
'Check values
atten=PA5x1.GetAtten
```



# zBUS Device

## About the zBUSx Methods

This section provides a listing of the available zBUSx ActiveX control methods.

### Programming Steps

- Add the zBUSx ActiveX controller to your program. The ActiveX help has examples for setting up ActiveX controllers in MATLAB, Visual Basic, and Visual C.
- Connect to a zBUS (USB or GB) device caddie (rack) with the connectZBUS function.
- Control the zBUS with the command and control functions using the ActiveX controller.

### ConnectZBUS

**Description:** Establishes a connection with a ZBUS device interface (GB or USB). ConnectZBUS returns 0 if unsuccessful and 1 when successful.

**'C' Prototype:** `long ConnectZBUS(LPCTSTR Interface);`

#### Arguments:

LPCTSTR      *Interface*                      Interface to which the device is connected.

Argument	Connection	Part #s
'GB '	Gigabit	PI5/FI5, PO5/FO5
'USB'	USB	UZ1, UZ2, UZ4

#### Returns:

long              0                      Connection not successful.  
long              1                      Connection successful.

#### Sample Code

**Description:** Connects to the ZBUS device via the Gigabit interface

```
MATLAB      % Connects to the ZBUS via Gigabit
zBUS=actxcontrol('ZBUS.x',[1 1 1 1])
if zBUS.ConnectZBUS('GB')
    e= 'connected'
else
    e= 'Unable to connect'
end

Visual Basic      'Connects to the ZBUS via the Gigabit
If zBUS.ConnectZBUS("GB") Then
    msgbox "Connection established"
Else
    msgbox "Error connecting to ZBUS"
End If
```

## FlushIO

**Description:** Clears the input and output values on the zBUS in order to remove bad data from the buffers.

**'C' Prototype:** `long FlushIO(long racknum);`

**Arguments:**

long *racknum* Rack number of the IO line to flush.

**Returns:**

long 0 Unable to Flush I/O lines.

long 1 Successfully Flushed I/O lines.

**Sample Code**

**Description:** Flushes the IO lines of zBUS device caddie 1.

**MATLAB** `% Flushes the zbus I/O lines  
zBUS.FlushIO(1)`

**Visual Basic** `'Flushes the zbus I/O lines  
zBUS.FlushIO(1)`

## GetDeviceAddr

**Description:** Returns the address of a device, given the device type and device number.

**'C' Prototype:** `long GetDeviceAddr(long Devtype, long devnum);`

**Arguments:**

long *Devtype* ID number of the device.

PA5	RP2	RL2	RA16	RV8	RX5	RX6	RX7	RX8	RZ2	RZ5
33	35	36	37	38	45	46	47	48	50	53

long *devnum* Device number (1-16) e.g. RP2\_1 is the first RP2 in the system (Note: Device number and physical position on the racks can differ).

**Returns:**

long 0 No such device type or device number.

long *n*>2 Even numbers indicate position 1 and odd numbers position 2 of the device caddie (rack).

For example:

2 = rack 1 position 1

3 = rack 1 position 2

4 = rack 2 position 1

**Sample Code**

**Description:** Gets the address of PA5\_1.

**MATLAB** `% Gets the device address  
zBUS.GetDeviceAddr(33,1)`

**Visual Basic** `Dim address As Integer  
'Get the device address  
address=zBUS.GetDeviceAddr(33,1)`

## GetDeviceVersion

**Description:** Checks the version of the device, or microcode of the device (programming information).

**'C' Prototype:** `long GetDeviceVersion(long Devtype, long devnum);`

**Arguments:**

long *Devtype* ID number of the device.

PA5	RP2	RL2	RA16	RV8	RX5	RX6	RX7	RX8	RZ2	RZ5
33	35	36	37	38	45	46	47	48	50	53

long *devnum* Device number (1-16) e.g. RP2\_1 is the first RP2 in the system (Note: Device number and physical position of the racks can differ).

**Returns:**

long 0 No such device type or device number.

long >16 Version of the microcode.

**TechNote:** RP2.1 returns a value of 1xx (xx=version number) for the version identification.

RL2 Base stations return a value of 135 for the version identification.

### Sample Code

**Description:** Checks to see if the Device has version 50 or greater of the microcode.

MATLAB

```
% Gets the device version
if zBUS.GetDeviceVersion(35, 1) < 50
    disp ' Update your microcode to run with this
ActiveX '
end
```

Visual Basic

```
Dim Vnum As Integer
'Gets the device version
If zBUS.GetDeviceVersion(35,1) < 50 Then
    msgbox "Update your microcode to run with this
ActiveX"
End If
```

## GetError

**Description:** Returns an error description from the zBUS.

**Note:** unsuccessful returns are not always the result of a zBUS error. For example, if a device does not exist at that address a return of zero is valid. The ActiveX controls are designed to produce few error calls.

**'C' Prototype:** `LPCTSTR GetError;`

**Arguments:** None

**Returns:**

LPCTSTR "" No Error

LPCTSTR "(LPCTSTR)" Possible Error descriptions: All Errors begin with ZERR  
 ARG\_OUT\_OF\_RANGE  
 UNABLE\_TO\_GET\_XBUS\_LOCK  
 UNKNOWN\_ERROR

```

XBUS_COMMUNICATION_ERROR
NO_INTERFACE_INITIALIZED
XBUS_GENERATED_ERROR
ACTIVE_ACCESS_UNAVAIL
PASSIVE_ACCESS_NOT_ALLOWED
MEMORY_ALLOC_FAILED
FAILED_READ_FROM_DEVICE
DEVICE_DRIVER_CODE_ERROR
SPECED_MEMORY_NOT_VALID
ILLEGAL_USB_DEVICE_SPECED
ZUSB_COM_ERROR
ZUSB_DEVICE_NOT_RESPOND
ZUSB_START_FAILURE
ZUSB_UNABLE_TO_ACC_DEV
CALL_NOT_SUPPORT_ON_INTER
DEVICE_SPEC_ERR

```

**Sample Code**

**Description:** Checks the Version number of the PA5 and returns a possible zBUS error.

```

MATLAB      % Gets the error string
            if zBUS.GetDeviceVersion(34, 1)==0
                e=zBUS.GetError
            end
Visual Basic 'Gets the error string
            If zBUS.GetDeviceVersion(34, 1)=0 Then
                msgbox zBUS.GetError
            End If

```

**HardwareReset**

**Description:** Resets the logical connection of the device caddie (rack) to the computer and returns a 0. Used to clear data lines and restore connections to the devices.

**'C' Prototype:** `long HardwareReset(long racknum);`

**Arguments:**

long            *racknum*            Caddie number to Reset.

**Returns:**

long            0                      Successfully performed a Hardware Reset.

**Sample Code**

**Description:** Hardware reset of device caddie number 1.

```

MATLAB      % Hardware Reset of the zbus I/O lines
            zBUS.HardwareReset(1)
Visual Basic 'Hardware Reset of the zbus I/O lines
            zBUS.HardwareReset(1)

```

**Important Note!:** See [Tech Note #181](#) for updated information on HardwareReset.

**zBusTrigA/zBusTrigB**

**Description:** Triggers several processor devices simultaneously either in one rack or over all racks. Trigger types include a single pulse varying in length (the length is

dependant on the sampling rate), a permanent logical high, or a permanent logical low.

**Note:** To generate a single sample pulse, connect an EdgeDetect component after the zTrig component in your RPvdsEx circuit.

Minimum delay time is 2 milliseconds per rack, e.g. if you trigger five racks the zBusTrig requires 10 milliseconds.

**Note:** Differences in sample rates will cause differences in the triggering of the clock.

**'C' Prototype:** `long zBusTrigA/B(long racknum, long Trig type, long delay);`

**Arguments:**

long	<i>Racknum</i>	0=all device caddies (racks) triggered n=racknum triggered.
long	<i>Trig type</i>	0=pulse, 1=high, 2=low.
long	<i>delay</i>	delay before trigger event occurs, must be a minimum of 2msec per rack.

**Returns:**

long	0	Unsuccessful.
long	1	Successful.

**Note:** In v57 and above, a zero will be returned even if the trigger is actually generated correctly. There are two ways to monitor the actual results.

In your RPvdsEx circuit:

Link the output of the zTrig component to a digital output on the device. This will allow the trigger result to be viewed on the front panel of the device.

Link a parameter tag to the output of the zTrig component and read this tag in MATLAB, to view the results.

**Sample Code**

**MATLAB**

**Description:** Two RP2 (devices 1 and 2) are loaded with the same circuit. They are triggered simultaneously using zBusTrigA. Only rack 1 receives the trigger. The delay is set for 3 msec just as a precaution and the trigger is a pulse. Both circuits are triggered simultaneously.

```
zBus=actxcontrol('ZBUS.x',[1 1 1 1])
zBus.ConnectZBUS('GB')
RP2_1=actxcontrol('RPco.x',[1 1 1 1])
RP2_2=actxcontrol('RPco.x',[1 1 1 1])
RP2_1.ConnectRP2('GB', 1)
RP2_1.LoadCOF('C:\Circuit')
RP2_1.Run
RP2_2.ConnectRP2('GB', 2)
RP2_2.LoadCOF('C:\Circuit')
RP2_2.Run
zBus.zBusTrigA(1, 0, 5)
```

**Visual Basic**

**Description:** Two RP2 (devices 1 and 2) are loaded with the same circuit. They are triggered simultaneously using zBusTrigA across all possible racks. The delay is set for 5 msec just as a precaution and the trigger is a pulse. Both circuits are triggered simultaneously.

```
zBus.ConnectZBUS("GB")
```

```

RP2_1.ConnectRP2("GB", 1)
RP2_1.LoadCOF("C:\Circuit")
RP2_1.Run
RP2_2.ConnectRP2("GB", 2)
RP2_2.LoadCOF("C:\Circuit")
RP2_2.Run
zBus.zBusTrigA(0, 0, 5)

```

## zBusSync

**Description:** Synchronizes the clocks across several device caddies (racks) to minimize drift. The clocks that drive the DSP can drift by as little as 0.01% over several seconds, producing clock differences of several microseconds. zBusSync ensures synchronization across devices.

To use zBusSync, connect the Sync lines on the UB1/UZ4 to be synchronized, using short BNC cables and T-connectors to minimize noise.

zBusSync uses a bitmask to identify a master and slave clocks. The first rack 'turned on' in the bitmask (according to the logical order of devices) is master and the rest are slaves, i.e. they get their clock signal from the master device.

This command should only be used with the UB1/UZ4 USB 1.1 interfaces. It will always return a zero when used with any other interface type.

**'C' Prototype:** `long zBusSync(long Bitmask Racknum);`

### Arguments:

long	<i>BitMask Racknum</i>	Bitmask values for the racknum. e.g. 5 means that device caddie 1 is the master and device caddie 3 is the slave synchronized clock. 6 means that device caddie 2 is the master and device caddie 3 is the slave.
------	------------------------	---

### Returns:

long	0	Unsuccessful.
long	1	Successful.

### Sample Code

#### MATLAB

**Description:** Synchronizes the clocks of zBus device caddies 1 and 2.

```

zBUS=actxcontrol('ZBUS.x',[1 1 1 1])
zBUS.ConnectZBUS('USB')
zBus.zBusSync(3)

```

#### Visual Basic

**Description:** Synchronizes the clocks of zBus device caddies 1, 2, 3, and 4.

```

zBus.ConnectZBUS("USB")
zBus.zBusSync(15)

```

# ActiveX Examples

The example programs included with the ActiveX disk are general programs that can be modified for other purposes. Most of the examples have been developed with MATLAB and Visual Basic, which produces very compact code without a great deal of Windows related code. Programmers using other languages would benefit from the MATLAB and VB examples as well.

*The steps generally used to develop example programs include:*

**Step 1:** Design a circuit using RpvdsEx.

**Step 2:** Create a Control Object File (\*.rco or \*.rcx).

**Step 3:** Create a program that implements TDT ActiveX controls.

Complete documentation for each example is provided in the MATLAB, Visual Basic, and Visual C++ example sections that follow.

## ***MATLAB Examples***

### **MATLAB Example: Circuit Loader**

This example documents a MATLAB program that lets the user load RPvdsEx control object files (\*.rcx) and run them on Real-Time Processors.

#### **ActiveX Methods Used**

- [ConnectRP2](#)
- [LoadCOF](#)
- [Run](#)
- [GetStatus](#)

#### **Files Used**

The file required for this example can be found in: *C:\TDT\ActiveX\ActXExamples\matlab*

- **Circuit\_Loader.m**: MATLAB (R13+) script file for loading a control object file (\*.rcx)

or

- **Circuit\_Loader\_R12.m**: MATLAB (R12) script file for loading a control object file (\*.rcx)

#### **Required Hardware**

- RP2

#### **Running the Application**

*To run the application:*

- At the MATLAB prompt type "**Circuit\_Loader**" and press the **Enter** key.

#### **Program Description**

The program prompts the user for the following information: Connection type (GB...), Device number, and COF (\*.rcx) name. The program then loads and runs the RPvdsEx circuit and checks for errors using GetStatus. It also returns the ActiveX object that is controlling the device.

#### **Relevant Code**

The first line of code below sets up a processor device ActiveX control in MATLAB. The next line connects the control to an RP2; the fourth line clears that processor device of its COF file and any memory buffers (this call is not required). The sixth line loads a COF (\*.rcx file) with the proper path and name designated. The seventh line of code starts the circuit. The eighth line checks the status of the circuit (7=loaded and running). All programs will use the Connect, LoadCOF, and Run when using ActiveX controls.



```

% Load circuit onto device and run
RP = actxcontrol('RPco.x',[5 5 26 26]);

RP.ConnectRP2(connectionType, deviceNumber);
% Connects RP2 via USB or GB given the proper device number
RP.Halt; % Stops any processing chains running on RP2
RP.ClearCOF; % Clears all the buffers and circuits on that RP2
disp(['Loading ' circuitPath]);
RP.LoadCOF(circuitPath); % Loads circuit
RP.Run; % Starts circuit

status=double(RP.GetStatus); % Gets the status
if bitget(status,1)==0; % Checks for connection
    disp('Error connecting to RP2'); return;
elseif bitget(status,2)==0; % Checks for errors in loading circuit
    disp('Error loading circuit'); return;
elseif bitget(status,3)==0 % Checks for errors in running circuit
    disp('Error running circuit'); return;
else
    disp('Circuit loaded and running'); return;
end

```

## MATLAB Example: Device Checker

This example uses ActiveX controls to load an RPvdsEx circuit. It checks the cycle usage to see if the circuit uses too much of the Real-Time Processor's processing time. High cycle usage (>90%) causes erratic behavior on the Real-Time Processor. It then finds the name of each component type and the name, data type, and size of each parameter tag.

### ActiveX Methods Used

- [GetCycUse](#)
- [GetNumOf](#)
- [GetNameOf](#)
- [GetTagType](#)
- [GetTagSize](#)

### Files Used

The files required for this example can be found in: *C:\TDT\ActiveX\ActXExamples\matlab*

- **Circuit\_Loader.m**: MATLAB (R13+) script file for loading a control object file (\*.rcx)
- **Device\_Checker.m**: MATLAB (R13+) script file for checking device properties

or

- **Circuit\_Loader\_R12.m**: MATLAB (R12) script file for loading a control object file (\*.rcx)
- **Device\_Checker\_R12.m**: MATLAB (R12) script file for checking device properties

### Required Hardware

- RP2

## Running the Application

### To run the application:

- At the MATLAB prompt type "**Device\_Checker**" and the **Enter** key.

This example uses Circuit\_Loader.m to load the circuit.

### Relevant Code

The first line checks the cycle usage of the Real-Time Processor. The second line of code finds the number of parameter tags. A loop then determines the String ID, Data type, and Data size for each parameter tag. The MATLAB example uses similar code for other types of components.

```
Cycle_Usage = RP.GetCycUse; % Checks cycle usage

% Gets the number of each of the component types:
NumParTags = RP.GetNumOf('ParTag');

% Gets the names of the Parameter Tags, The TagType (data type), %
and TagSize
for z = 1:NumParTags
    PName = RP.GetNameOf('ParTag',z);
    % Returns the Parameter name
    PType = char(RP.GetTagType(PName));
    % Returns the Tag Type: Single, Integer, Data, Logical
    PSize = RP.GetTagSize(PName);
    % Returns TagSize (size of Data Buffer or 1)
    disp(['    ' PName '    type ' PType '    size '
num2str(PSize)]);
end
```

## MATLAB Example: Band Limited Noise

This example loads an RpvdsEx circuit that generates variable intensities of band limited noise and checks the output for clipping. User control of the frequency and intensity of the noise can be set through the MATLAB command window.

### ActiveX Methods Used

- [SetTagVal](#)
- [GetTagVal](#)

### Files Used

The file required for this example can be found in: *C:\TDT\ActiveX\ActXExamples\matlab*

- **Band\_Limited\_Noise.m**: MATLAB (R13+) script file for running \*.rcx file

or

- **Band\_Limited\_Noise\_R12.m**: MATLAB (R12) script file for running \*.rcx file

The RpvdsEx file used can be found in: *C:\TDT\ActiveX\ActXExamples\RP\_files*

- **Band\_Limited\_Noise.rcx**

### **Required Hardware**

- RP2

### **Required Applications**

- RpvdsEx
- MATLAB

### **Running the Application**

#### *To run the application:*

- In the Command Window type "**Band\_Limited\_Noise**" at the prompt.

### **Making the RpvdsEx Circuit**

#### *Component types required:*

- Five parameter tags. To change the name, double-click the parameter tag and type a new name.
  - Gain - Increases the relative bandpass filtering in dB
  - Freq - Center frequency of the bandpass
  - BW - Width of the bandpass (3dB roll off)
  - Amp - Changes the amplitude of the noise
  - Enable - Starts and stops generation of the filter coefficients
  - Clip - Checks to see if the signal is clipped
- Gaussian noise generator (waveform generator)
- Parametric filter coefficient generator
- Biquad filter
- Feature search
- Schmitt trigger
- DacOut
- BitOut

#### *Connect the circuit as shown below:*

**Note:** Double click on any RpvdsEx and then click on the help button to access the RpvdsEx components help.

The two boxes represent the different parts of the circuit. The box on the left includes components that generate (GaussNoise) and filter (ParaCoef/Biquad) the waveform. The parameter tags are used to set the amplitude of the noise and filter parameters. The second part of the circuit, found in the box on right, checks for clipping (signal values greater than +/- 10 Volts) and generates a high signal on Bit 0 (M=1) of the processor device.

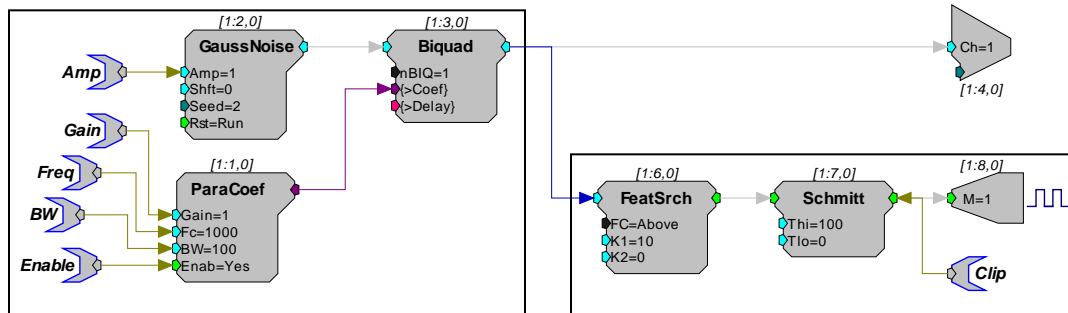

## Program Description

This program controls a circuit that generates band-limited noise. The user controls the center frequency, bandwidth, and the intensity of the filtered noise. If the parameters produce clipping the user is prompted to change some of the parameters. The relevant code controls or receives information about the circuit through parameter tags.

## Relevant Code

The code below sets the values of a series of tags. Each tag sends the value to the component port(s) (e.g. Gain) to which they are connected.

```
% User gives information about the center frequency, Bandwidth,
% gain of filter, and amplitude of noise
Freq=input('Enter the center frequency for the filter: ');
Gain=input('Enter the dB gain for the filter: ');
Bandwidth=input('Enter the bandwidth for the filter: ');
Amp=input('Enter the intensity for the noise: ');
% Sets the initial settings for the filter coefficients and the
% noise
RP.SetTagVal('Gain', Gain); % Gain of band limited filter
RP.SetTagVal('Freq', Freq); % CenterFrequency
RP.SetTagVal('BW', Bandwidth); % Bandwidth of filter
RP.SetTagVal('Amp', Amp); % Amplitude of the Gaussian Noise
% Loads Coefficients to Biquad Filter
RP.SetTagVal('Enable', 1);
RP.SetTagVal('Enable', 0); % Stops Coefficient generator from
sending signal (saves on cycle usage)
```

## GetTagVal

This code checks for clipping. A parameter tag is polled once every 100 msec. It returns a one if the signal is clipped and a zero if it is not. The GetTagVal returns the state of the Schmitt trigger (high or low).

```
while quit==0
    Clip=RP.GetTagVal('Clip'); % Checks to see if signal is
    clipped (top light on panel is on while clipping occurs)
    if Clip==1
        disp('Gain of filter or noise intensity is too high');
```

## MATLAB Example: Continuous Acquire

This example uses a circuit that continuously saves data to a 100,000 sample buffer at 100 kHz. It continuously reads from a serial buffer in 50,000 sample chunks and saves the first 1,000,000 samples to a f32 file.

## ActiveX Methods Used

- [ReadTagV](#)

- [SoftTrg](#)
- [GetTagVal](#)

### Files Used

The file required for this example can be found in: *C:\TDT\ActiveX\ActXExamples\matlab*

- Continuous\_Acquire.m: MATLAB (R13+) script file for running \*.rcx file  
or
- Continuous\_Acquire\_R12.m: MATLAB (R12) script file for running \*.rcx file

The RPvdsEx file used can be found in: *C:\TDT\ActiveX\ActXExamples\RP\_files*

- Continuous\_Acquire.rcx: RPvdsEx circuit

### Required Hardware

- RP2

### Required Applications

- RPvdsEx
- MATLAB

### Running the Application

*To run the application:*

- In the Command Window type "**Continuous\_Acquire**" at the prompt.

### Making the RPvdsEx Circuit

*Component types required:*

- Two Parameter tags. To change the name of a parameter tag, double-click on the parameter and type a new name.
  - dataout - Points to the memory buffer
  - index - Points to the index of the serial buffer.
- Two soft triggers (Soft1 and Soft2). To change the trigger to a soft trigger, double-click the trigger and click on the drop down menu under Trigger type. Change one to Soft1 and the other to Soft2.
- AdcIn
- RSFlipFlop
- SerialBuf. To change the size of the serial buffer's memory, double-click the serial buffer and change Size to 100000.

*Connect the circuit as shown below:*

**Note:** Double click on any RPvdsEx and then click on the help button to access the RPvdsEx components help.

The circuit below uses a Serial Buffer to acquire a signal. The signal is captured to a serial buffer, downloaded to the PC and stored in a file named fnoise2. To demonstrate the circuit, a Gaussian noise signal is generated (not shown). Removal of the noise generator portion of the circuit does not affect the MATLAB script.

Data is continuously acquired by channel one but is only saved to the serial buffer when the AccEnab line is set high. The two soft-triggers control the start and stop of the data acquisition.

When Soft1 goes high, the RSFlipFlop goes high and stays high. This sets the AccEnab line high and the serial buffer starts saving the data. The serial buffer holds 100,000 samples. When the buffer captures more than 100,000 points the end of memory is reached, the index is reset to 0, and any data in memory is written over. When data cannot be downloaded to the PC fast enough it gets overwritten in the buffer.

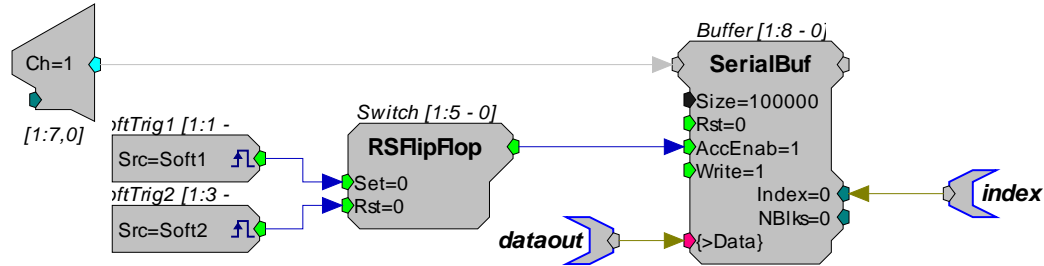

### Program Description

The program acquires 10 seconds of signal at 100 kHz sampling rate and stores it in a file. A software trigger starts the counter and the signal is stored in the serial buffer. The serial buffer index is polled until 50,000 points are read into the buffer. The data is then sent to an array using ReadTagV and the data array is stored in a data file. The counter is polled until the next 50,000 points are read and the cycle is repeated. Each time the data is sent to the PC the program checks to see if the transfer rate is fast enough. A final software trigger ends the data acquisition. The last half second of data acquisition is plotted.

### Relevant Code

This part of the code starts acquisition of the data by the serial buffer. It then checks to see if the buffer is half-filled. Half of the buffer is acquired while the other half is being filled. This method is called double buffering and allows for continuous acquisition data to be written to the *fnoise2* file in separate half-buffer partitions. Double buffering allows the circuit to continuously acquire data while it also writes the older data to the *fnoise2* file.

```
% Begin acquiring
RP.SoftTrg(1);

% Main Looping Section
for i = 1:10
    curindex=RP.GetTagVal('index');
    disp(['Current index: ' num2str(curindex)]);

    % Wait until first half of Buffer fills
    while(curindex<bufpts)
        % Check to see if it has read into half the buffer
        curindex=RP.GetTagVal('index');
    end

    % Read first segment
    noise=RP.ReadTagV('dataout', 0, bufpts);
    % Read from the buffer
    disp(['Wrote ' num2str(fwrite(fnoise,noise,'float32')) '
points to file']); % Writes to a file

    % Check to see if the data transfer rate is fast enough
    curindex=RP.GetTagVal('index');
    disp(['Current index: ' num2str(curindex)]);
    if (curindex<bufpts)
        disp('Transfer rate is too slow');
    end
end
```

```

% Wait until second half of buffer fills
while(curindex>bufpts)
    curindex=RP.GetTagVal('index');
end

% Read second segment
noise=RP.ReadTagV('dataout', bufpts, bufpts);
% Reads from the buffer
disp(['Wrote ' num2str(fwrite(fnoise,noise,'float32')) '
points to file']); % Writes to a file

% Check to see if the data transfer rate is fast enough
curindex=RP.GetTagVal('index');
disp(['Current index: ' num2str(curindex)]);
if(curindex>bufpts)
    disp('Transfer rate is too slow');
end

% Loop back to start of data capture routine.
end

```

## MATLAB Example: Continuous Play

This example uses a circuit that continuously loads data to a 100,000 sample buffer at 100 kHz and sends the signal out for play to a DAC and a MATLAB script file that continuously writes to a serial buffer in 50,000 sample chunks.

### ActiveX Methods Used

- [WriteTagV](#)
- [SoftTrg](#)
- [GetTagVal](#)

### Files Used

The file required for this example can be found in: *C:\TDT\ActiveX\ActXExamples\matlab*

- Continuous\_Play.m: MATLAB (R13+) script file for running \*.rcx file
- or
- Continuous\_Play\_R12.m: MATLAB (R12) script file for running \*.rcx file

The RPvdsEx file used can be found in: *C:\TDT\ActiveX\ActXExamples\RP\_files*

- Continuous\_Play.rcx: RPvdsEx circuit

### Required Hardware

- RP2

### Required Applications

- RPvdsEx
- MATLAB

### Running the Application

*To run the application:*

- In the Command Window type "**Continuous\_Play**" at the prompt.

## Making the RpvdsEx Circuit

### Component types required:

- Two parameter tags. To change the name of a parameter tag, double-click on the parameter and type a new name.
  - datain - Points to the memory buffer
  - index - Points to the index of the serial buffer
- Two soft triggers (Soft1 and Soft2). To change the trigger to soft trigger, double-click the trigger and select the trigger type from the drop down menu under Trigger Type. Change one to Soft1 and the other to Soft2.
- DacOut
- RSFlipFlop
- SerialBuf. To change the size of the serial buffer's memory, double-click the serial buffer and set Size to 100000.

Your circuit should look like the one below. The signal is generated on the PC and then loaded into the serial buffer for play out.

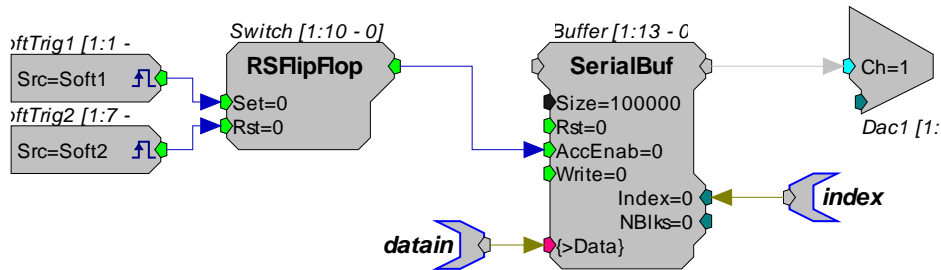

When the Soft1 trigger goes high, the FlipFlop goes high and stays high. This sets the AccEnab line high and the serial buffer starts sending the data out to the DAC. When the serial buffer has played out 100,000 points the index is reset and the data at the beginning of the buffer is played out. As long as the AccEnab is high the serial buffer will play the signal.

### Program Description

The program plays a series of tones for 10 seconds. The first second of tones is loaded to the serial buffer. A software trigger starts the counter and the signal is played out through the DAC. The serial buffer index is polled until 50,000 points are played from the buffer. Another tone is generated and loaded to the first half of the buffer. The counter is polled until the next 50,000 points are played out and the cycle is repeated. The program checks to see if the transfer rate is fast enough when the data is written to the buffer. A final software trigger ends the play out.

### Relevant Code

This section writes the tones to the serial buffer. The first call to WriteTagV writes the signal named s1 to the first half of the buffer and the second call writes signal s2 to the second half of the buffer. Half of the buffer is written to, while the other half is being read to play out a tone.

This method is called double buffering and is used to read the data values of the tones into one half of the buffer while the other half is being played out. This allows the example to play tones continuously.

```
RP.WriteTagV('datain', 0, s1);
RP.WriteTagV('datain', bufpts-1, s2);
```



```

% This section starts the signal payout. Once half the buffer
% is played out it loads the next signal. After ten seconds,
% the second software trigger sets the AccEnab line low and
% stops play out.

% Start Playing
RP.SoftTrg(1);
curindex=RP.GetTagVal('index');

% Main Looping Section
for i = 1:10

    % Wait until done playing A
    while(curindex < bufpts) % Checks to see if it has
    % played from half the buffer
        curindex=RP.GetTagVal('index');
    end

    % Loads the next signal segment
    freq1=freq1+1000;
    s1=sin(2*pi*t*freq1);
    RP.WriteTagV('datain', 0, s1);

    % Checks to see if the data transfer rate is fast
    % enough
    curindex=RP.GetTagVal('index');
    if(curindex < bufpts)
        disp('Transfer rate is too slow');
    end

    % Wait until start playing A
    while(curindex > bufpts)
        curindex=RP.GetTagVal('index');
    end

    % Load B
    freq2=freq2+1000;
    s2=sin(2*pi*t*freq2);
    RP.WriteTagV('datain', bufpts, s2);

    % Make sure still playing A
    curindex=RP.GetTagVal('index');
    if(curindex > bufpts)
        disp('Transfer rate is too slow');
    end

    % Loop back to wait until done playing A
end

% Stop playing
RP.SoftTrg(2);
RP.Halt;
end

```

## MATLAB Example: FIR Filtered Noise

This example documents a program that uses a noise generator to output a signal. An FIR filters the signal and the filtered and unfiltered signals are played out of two DACs.

### ActiveX Methods

- [SendSrcFile](#)
- [SendParTable](#)

### Files Used

The file required for this example can be found in: *C:\TDT\ActiveX\ActXExamples\matlab*

- FIR\_filtered\_noise.m: MATLAB (R13+) script file for running \*.rcx file  
or
- FIR\_filtered\_noise\_R12.m: MATLAB (R12) script file for running \*.rcx file

The RpvdsEx file used can be found in: *C:\TDT\ActiveX\ActXExamples\RP\_files*

- FIR\_Filtered\_Noise.rcx: RpvdsEx circuit

### Required Hardware

- RP2

### Required Applications

- RpvdsEx
- MATLAB

### Running the Application

*To run the application:*

- In the Command Window type "**FIR\_Filtered\_Noise**" at the prompt.

### Making the RpvdsEx Circuit

*Component types required:*

- GaussNoise. To change the parameters of the noise signal double click the icon and edit the values
- Data Table. The data table provided with the circuit contains the FIR filter coefficients for low, high, and bandpass filters. The coefficients were generated in MATLAB and pasted into the data table. You will need to use the RpvdsEx file "FIR\_Filtered\_Noise.rcx" which is provided in the ActiveX installation to use these filter coefficients.
- FIR filter. To change the order of the FIR, double-click the component and change Order to 100.
- Two DacOuts. Channel 2 plays out the unfiltered signal. Channel 1 plays out the filtered signal.

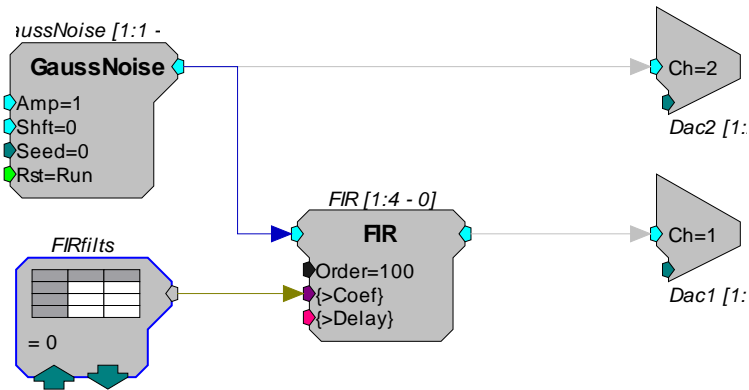

The circuit uses a GaussNoise component to output a signal. The signal is then filtered with an FIR (low, high or bandpass) filter whose coefficients are loaded from a data table. The signals are played out on Channel 1(filtered) and Channel 2(unfiltered) for comparison purposes.

Each section of signal is filtered three times: a low pass filter, high pass filter, and band pass filter. The program cycles through these three filter settings. Filters were generated in MATLAB as FIR filters with 100 taps.

### Relevant Code

```
% Cycles through the three FIR filters
for i = 1:3
    % Loads one set of filter coefficients to an FIR
    RP.SendParTable('FIRfilt', i);
    pause(2);
end
% Stop playing
RP.Halt;
```

## MATLAB Example: Two Channel Acquisition with ReadTagVEX

This example uses a circuit that continuously acquires data from two channels at 100 kHz per channel. It continuously reads from a serial buffer in 50,000 sample chunks and saves the data in matrix format to disk.

### ActiveX Methods

- [ReadTagVEX](#)
- [SoftTrg](#)
- [GetTagVal](#)

### Files Used

The file required for this example can be found in: *C:\TDT\ActiveX\ActXExamples\matlab*

- TwoCh\_Continuous\_Acquire.m: MATLAB (R13+) script file for running \*.rcx file
- or
- TwoCh\_Continuous\_Acquire\_R12.m: MATLAB (R12) script file for running \*.rcx file

The RPvdsEx file used can be found in: *C:\TDT\ActiveX\ActXExamples\RP\_files*

- TwoCh\_Continuous\_Acquire.rcx: RPvdsEx circuit

## Required Hardware

- RP2

## Required Applications

- RpvdsEx
- MATLAB

## Running the Application

### To run the application:

- In the Command window type "**TwoCh\_Continuous\_Acquire**" at the prompt.

## Making the RpvdsEx Circuit

### Component types required:

- Two Parameter tags. To change the name, double-click the parameter tag and type a new name.
  - dataout - Points to the memory buffer
  - index - Points to the index of the serial buffer.
- Two soft triggers (Soft1 and Soft2). To change the trigger to a soft trigger, double-click the trigger and select a trigger from the drop down menu under Trigger Type. Change one to Soft1 and the other to Soft2.
- Two AdcIns
- RSFlipFlop
- ShufTo16. This component reduces two 32-bit floating point input values to 16 bits each. The 16-bit values are then stored in the upper and lower half of a 32-bit output. At a 100 kHz sampling rate, it is possible to stream two channels to disk in real-time.
- SerialBuf. To change the size of the serial buffer's memory, double-click the serial buffer component and change the Size to 100000.

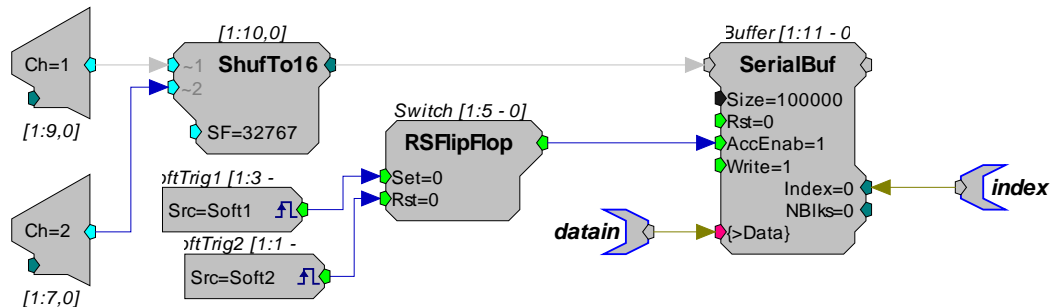

The circuit uses a SerialBuf and ShufTo16 to acquire two channels of data continuously at a 100 kHz sampling rate. The signal is captured to a serial buffer, downloaded to the PC, and stored in a file.

**Note:** This circuit contains a Gaussian noise generator that is output to DAC OUT-1 and a tone generator that is output to DAC OUT-2.

## Program Description

The program is very similar to the Continuous Acquire MATLAB example. It acquires 10 seconds of signal from two channels at 100 kHz sampling rate and stores it in a file.

A software trigger starts the counter and a signal is stored in the serial buffer. The counter is polled until 50,000 points are read into the buffer. The data is then downloaded to a MATLAB array, which is stored in a data file. The counter is polled until the next 50,000 points are read and the cycle is repeated. Each time the data is sent to the PC the program checks to see if the transfer rate is fast enough. A final software trigger ends the data acquisition. The last half second of the acquired data is plotted.

### Relevant Code

Check Continuous Acquire, page 76, for a description of the general program. This code reads the data from the buffer. I16 is the source type of the data on the processor device; F64 is how the data is stored on the PC.

```
noise=RP2.ReadTagVEX('dataout', 0, bufpts, 'I16', 'F64', 2);
% Reads from the buffer
```

## MATLAB example: Two Channel Play with WriteTagVEX

This example uses a circuit that continuously plays a signal out of two channels at 100 kHz per channel. It continuously writes to a serial buffer in 50,000 sample chunks.

### ActiveX Methods

- [WriteTagVEX](#)
- [SoftTrg](#)
- [GetTagVal](#)

### Files Used

The file required for this example can be found in: *C:\TDT\ActiveX\ActXExamples\matlab*

- TwoCh\_Continuous\_Play.m: MATLAB (R13+) script file for running \*.rcx file  
or
- TwoCh\_Continuous\_Play\_R12.m: MATLAB (R12) script file for running \*.rcx file

The RPvdsEx file used can be found in: *C:\TDT\ActiveX\ActXExamples\RP\_files*

- TwoCh\_Continuous\_Play.rcx: RPvdsEx circuit

### Required Hardware

- RP2

### Required Applications

- RPvdsEx
- MATLAB

### Running the Application

*To run the application:*

- In the Command Window type "**TwoCh\_Continuous\_Play**" at the prompt.

## Making the RpvdsEx Circuit

### Component types required:

- Two parameter tags: To change the name of a parameter tag, double-click it then type a new name.
  - Dtain - Points to the memory buffer
  - Index - Points to the index of the serial buffer.
- Two software triggers (Soft1 and Soft2). To change the trigger to soft trigger, double-click on the trigger and click on the drop down menu under Trigger Type. Change one to Soft1 and the other to Soft2.
- Two DacOuts
- RSFlipFlop
- SplitFrom16
- A serial buffer (SerialBuf). To change the size of the serial buffer's memory, double-click the component and change the Size to 100000.

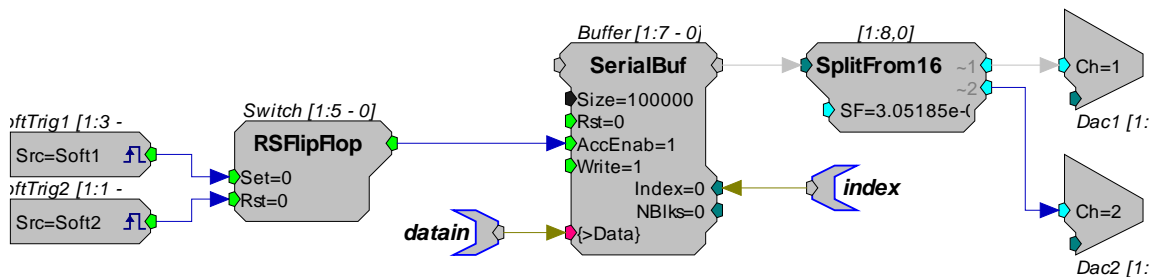

The circuit below uses a SerialBuf and SplitFrom16 to play out signals to two channels continuously. The signal is generated on the PC and then loaded into the serial buffer memory.

The circuit is similar to the Continuous Play example. When Soft Trigger 1 goes high the FlipFlop goes high and stays high. This sets the AccEnab line high and the serial buffer starts sending the data out to the DAC. When the serial buffer has played out 100,000 points, the index is reset and the data at the beginning of the buffer is played out. As long as the AccEnab is high the serial buffer will play the signal. The signal from the serial buffer memory is split into two channels with SplitFrom16 and both channels are played out on DAC OUT-1 and DAC OUT-2.

### Program Description

This program generates two tones in MATLAB, stores them in a matrix, and loads them to the serial buffer's memory with WriteTagVEX. The general format for generating the signal with WriteTagVEX is shown below. Otherwise, this example is similar to the [Continuous Play](#) example.

### Relevant Code

The signals must be generated and scaled to fit the format for WriteTagVEX and SplitFrom16. For SplitFrom16 the format must be 16-bit integer. The scaling factor determines the amplitude of the signal; in this case the scaling factor assumes a +/- 1.0 V input signal to a +/- 10 V output. The floating point signals are converted to integer format with a 16-bit range. The two signals are then placed in a matrix.

```
% Two-Channel Continuous Play example using a serial buffer
% This program writes to the rambuffer once it has cycled half
% way through the buffer.
Npts=100000; % Size of the serial buffer
bufpts=npts/2; % Number of points to write to buffer
```

```

RP=Circuit_Loader('C:\TDT\ActiveX\ActXExamples\RP_files\TwoCh_C
ontinuous_Play.rcx');
if all(bitget(RP.GetStatus,1:3))
    % Generate two tone signals to play out in MATLAB
    freq1=1000;
    freq2=5000;
    fs=97656.25;
    t=(1:bufpts)/fs;
    s1=round(sin(2*pi*t*freq1)*32760);
    s2=round(sin(2*pi*t*freq2)*32760);
    % Serial buffer will be divided into two buffers A & B
    % Load up entire buffer with segments A and B
    s=[s1;s2]; % Concatenate two arrays into a matrix

```

The signals are loaded with WriteTagVEX. The format below with 'I16' indicates 16-bit integer format. WriteTagVEX determines the properties of the variant used for signal generation.

```
RP2.WriteTagVEX('datain', 0, 'I16', s);
```

## Visual Basic Examples – VB2005

**Important!:** Microsoft .NET Framework version 2.0 or greater is required to run all VB2005 examples.

### VB2005 Example: Circuit Loader

This example documents a Visual Basic program that lets the user load RPsEx control files (\*.rcx) and run them on RP, RX, and RZ processors.

#### ActiveX Methods Used

- [ConnectRP2](#)
- [LoadCOF](#)
- [GetStatus](#)
- [ClearCOF](#)
- [Run](#)
- [Halt](#)

#### Files Used

The executable file required for this example can be found in:

*C:\TDT\ActiveX\ActXExamples\vb\VB2005\Circuit\_Loader\bin\Release*

- Circuit\_Loader.exe: compiled executable; for running the example without having to start up Visual Basic

The source files used to create this example can be found in:

*C:\TDT\ActiveX\ActXExamples\vb\VB2005\Circuit\_Loader*

- frmCLMain.vb: contains an ActiveX component for the RP2
- frmCLMain.Designer.vb: Visual Basic form; includes graphical interface and VB code

#### Required Hardware

- At least one processor module (either RP2, RP2.1, RA16, RXx, or RZ2)

## Required Applications

- Visual Basic

## Running the Application

- Run the CircuitLoader.exe executable file from the Release directory, or load the Circuit\_Loader.vbproj project into Visual Basic and run it from there.

## Program Description

The Visual Basic program presents a graphical interface through which the user can load various circuits to TDT processors. The user selects the type of device, the interface (Gigabit or USB), and the device number (from 1 to 8) through radio buttons and input boxes. When the Load Circuit button is clicked, a file dialog box lets the user choose the \*.rcx file, and then it is loaded to the correct device based on the current settings of the user interface. A label is updated to show whether the circuit was loaded successfully or if an error occurred. 32 ActiveX controls are used in the program, one for each device that can potentially be used. The Check device button is used to display device information regarding the system cycle usage, parameters used, and number of components used in the .rcx file in the text area shown in the figure below.

## Relevant Code

The code below is run when the user clicks on the "Load Circuit" button. It displays a dialog window to select the \*.rcx file, connects to the appropriate device, and loads and runs the circuit.

```
'Opens a control to select the desired .rcx file
OpenFileDialog.ShowDialog()
'Saves the filepath to the appropriate file
Dim filepath As String = OpenFileDialog.FileName()
'Loads chosen circuit to the specific device/interface selected
If rbModuleRP2.Checked Then
    devType = "RP2.1"
    RP.ConnectRP2(connType, num)
ElseIf rbModuleRA16.Checked Then
    devType = "RA16"
    RP.ConnectRA16(connType, num)
ElseIf rbModuleRX5.Checked Then
    devType = "RX5"
    RP.ConnectRX5(connType, num)
ElseIf rbModuleRX6.Checked Then
    devType = "RX6"
    RP.ConnectRX6(connType, num)
ElseIf rbModuleRX7.Checked Then
    devType = "RX7"
    RP.ConnectRX7(connType, num)
ElseIf rbModuleRX8.Checked Then
    devType = "RX8"
    RP.ConnectRX8(connType, num)
ElseIf rbModuleRZ2.Checked Then
    devType = "RZ2"
    RP.ConnectRZ2(connType, num)
End If
'Check status button action
Dim msg As String = ""
If (RP.GetStatus() And 7) <> 7 Then
    msg = "Error loading circuit on"
Else
    msg = "Circuit loaded on"
    btnCheckDevice.Enabled = True
End If
lblStatus.Text = msg & devType & " #" & num
```



## VB2005 Example: Band Limited Noise

This example uses a circuit that produces band-limited noise and a Visual Basic program that lets the user control filter and noise settings, start and stop output, and monitor circuit status.

### ActiveX Methods Used

- [ConnectRP2](#)
- [Run](#)
- [GetSFreq](#)
- [ClearCOF](#)
- [Halt](#)
- [GetCycUse](#)
- [LoadCOF](#)
- [SetTagVal](#)
- [GetStatus](#)
- [GetTagVal](#)

### Files Used

The executable file required for this example can be found in:

*C:\TDT\ActiveX\ActXExamples\vb\VB2005\Band\_Limited\_Noise\bin\Release*

- Band\_Limited\_Noise.exe: compiled executable; for running the example without having to start up Visual Basic

The source files used to create this example can be found in:

*C:\TDT\ActiveX\ActXExamples\vb\VB2005\Band\_Limited\_Noise*

- frmBLNMain.vb: contains an ActiveX component for the RP2
- frmBLNMain.Designer.vb: Visual Basic form; includes graphical interface and VB code

The RPvdsEx file used can be found in: *C:\TDT\ActiveX\ActXExamples\RP\_files*

- Band\_Limited\_Noise.rcx: RPvdsEx file needed to run the VB code on the RP2

### Required Hardware

- RP2

### Required Applications

- RPvdsEx
- Visual Basic

### Running the Application

- Run the Band\_Limited\_Noise.exe executable file from the Release directory, or load the Band\_Limited\_Noise.vbproj project into Visual Basic and run it from there.

### Making the RPvdsEx Circuit

#### *Required components:*

- Six parameter tags (ParTag). To change the name of a parameter tag, double-click on the parameter and type a new name.
  - Gain - increases the relative bandpass filtering in dB

- Freq - center frequency of the bandpass filter
  - BW - width of the bandpass filter (3 dB rolloff)
  - Amp - changes the amplitude of the noise
  - Enable - toggles generation of the filter coefficients
  - Clip - checks to see whether the signal was clipped or not
- Gaussian noise generator (GaussNoise)
  - Parametric filter coefficient generator (ParaCoef)
  - Biquad filter (Biquad)
  - Feature search (FeatSrch)
  - Schmitt trigger (Schmitt)
  - Digital-to-analog converter (DacOut)
  - Digital bit output (BitOut)

Connect the circuit as shown below. The online help is accessible from within RPvdsEx if it is required. The two boxes represent the different parts of the circuit.

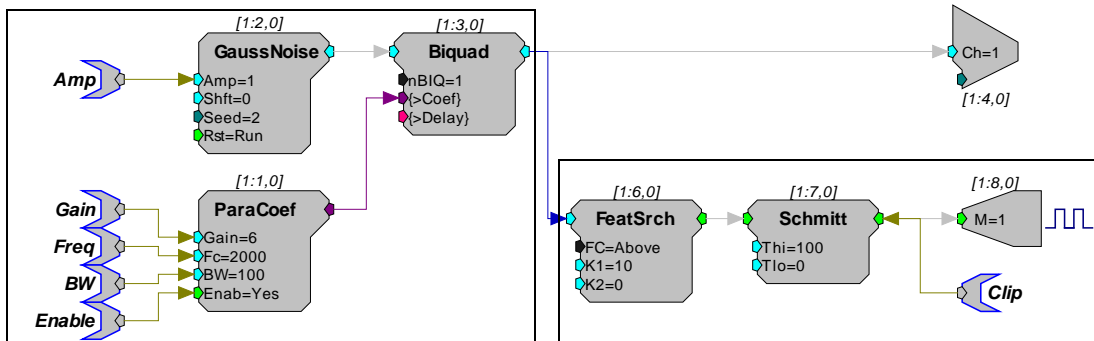

The box on the left has components that generate (GaussNoise) and filter (ParaCoef/Biquad) the waveform. The parameter tags are used to set the amplitude of the noise and filter parameters. The second part of the circuit (box on right) checks for clipping (signal values greater than +/- 10 volts) and generates a high signal on Bit 0 (M=1) of the processor device.

### Program Description

The Visual Basic program controls a circuit that generates band-limited noise. Buttons allow the user to load the circuit and start and stop the output signal. Through input boxes, the user controls the center frequency, bandwidth, filter gain, coefficient generation, and the intensity of the filtered noise. The sample rate and cycle usage are displayed, along with a warning box that is marked if the parameters produce clipping. Once the program has successfully loaded the circuit and the user starts the program, any changes made to the parameters such as Gain, Bandwidth, Amplitude, etc., can be dynamically updated by pressing the Update Parameters button (not pictured, it is available while running). The relevant code controls or receives information about the circuit through parameter tags. An ActiveX control is used for the RP2 device, and a Timer control is used for monitoring the cycle usage of the circuit.

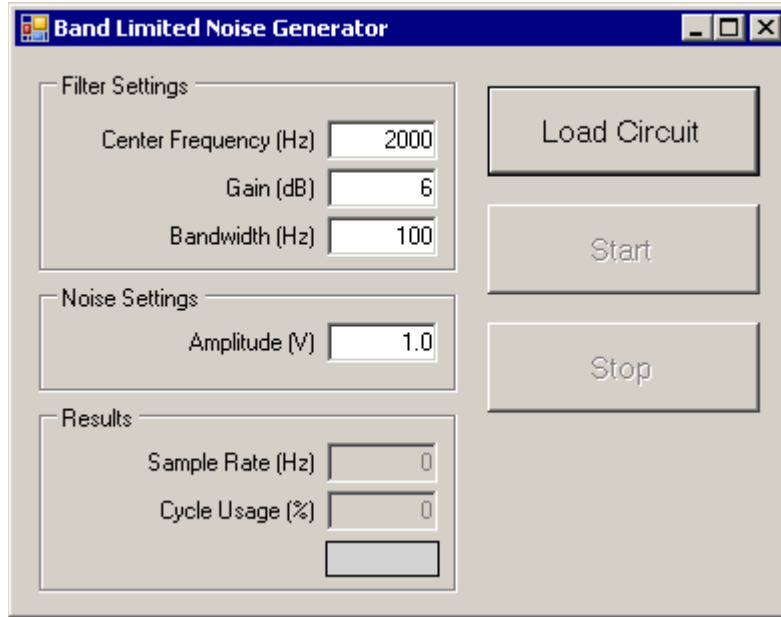

### Relevant Code

The code below is run when the user clicks on the "Load Circuit" button. It connects to the RP2, loads the circuit, and makes sure everything was loaded successfully.

```
'Connect via Gigabit or USB
If RP.ConnectRP2("GB", 1) = 0 Then
    If RP.ConnectRP2("USB", 1) = 0 Then
        MsgBox "Error connecting to RP2"
        Exit Sub
    End If
End If
'Load the circuit
RP.ClearCOF()
RP.LoadCOF(Circuit)
'Check status
Dim Status As Integer = RP.GetStatus
If (Status And 1) = 0 Then
    MsgBox "Error connecting to RP device; status: " & Status
    RP.Halt()
```

The code below is run when the user clicks on the "Start Circuit" button. It sets the values of each parameter based on the values in the input boxes of the graphical interface. It then starts the circuit running, which plays the noise out of the RP2 on output channel OUT-1.

```
'Set parameters
RP.SetTagVal("Amp", CSng(txtAmplitude.Text))
RP.SetTagVal("Freq", CSng(txtCenterFrequency.Text))
RP.SetTagVal("BW", CSng(txtBandwidth.Text))
RP.SetTagVal("Gain", CSng(txtGain.Text))
RP.SetTagVal("Enable", 1)
'Begin
RP.Run()
```

The results (checking for clipping and display of cycle usage) are updated every 50 ms by a timer. This is done by the following code:

```
'Check for Clipping, if present set clipping display
If CBool(RP.GetTagVal("Clip")) Then
    lblClipped.BackColor = Color.Red
    lblClipped.ForeColor = Color.White
Else
```

```
lblClipped.BackColor = Color.LightGray  
lblClipped.ForeColor = Color.LightGray  
End If  
txtCycleUsage.Text = RP.GetCycUse()
```

## VB2005 Example: Continuous Acquire

This example uses a circuit that continually acquires data from an input channel into a 100,000 sample serial buffer at a rate of 100 kHz and a Visual Basic program that continually reads from the serial buffer in blocks of 50,000 samples and saves the data to a file.

### ActiveX Methods Used

- [ConnectRP2](#)
- [GetStatus](#)
- [GetTagVal](#)
- [SoftTrg](#)
- [Run](#)
- [ReadTagVEX](#)
- [LoadCOF](#)
- [Halt](#)

### Files Used

The executable file required for this example can be found in:

*C:\TDT\ActiveX\ActXExamples\vb\VB2005\Continuous\_Acquire\bin\Release*

- Continuous\_Acquire.exe: compiled executable; for running the example without having to start up Visual Basic

The source files used to create this example can be found in:

*C:\TDT\ActiveX\ActXExamples\vb\VB2005\Continuous\_Acquire*

- frmCAMain.vb: contains an ActiveX component for the RP2
- frmCAMain.Designer.vb: Visual Basic form; includes graphical interface and VB code

The RPvdsEx file used can be found in: *C:\TDT\ActiveX\ActXExamples\RP\_files*

- Continuous\_Acquire.rcx: RPvdsEx file needed to run the VB code on the RP2

### Required Hardware

- RP2

### Required Applications

- RPvdsEx
- Visual Basic

### Running the Application

- Run the Continuous\_Acquire.exe executable file from the Release directory, or load the Continuous\_Acquire.vbproj project into Visual Basic and run it from there.

## Making the RPvdsEx Circuit

### Required components for acquisition:

- Two parameter tags (ParTag). To change the name of a parameter tag, double-click the parameter and type a new name.
- dataout - points to the memory buffer
- index - points to the index of the serial buffer
- Two software triggers (TrgIn, set to Soft1 and Soft2)
- Analog-to-digital converter (AdcIn)
- RS flip-flop (RSFlipFlop)
- Serial buffer (SerialBuf). To change the size of the serial buffer's memory, double-click the component and change the value for Size to 100000 (for this example).

Connect the circuit as shown below. The RPx online help is accessible from within RPvdsEx if it is required.

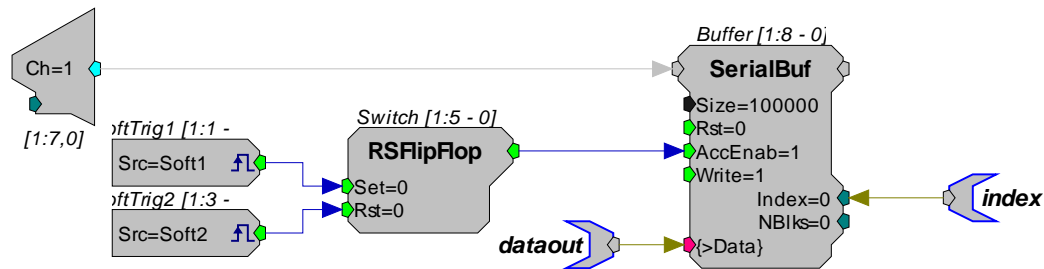

Data is continuously acquired on channel one but is only saved to the Serial buffer when the AccEnab line is set high. The two software triggers control the start and stop of the data acquisition. When Soft1 goes high the RSFlipFlop goes and stays high. This sets the AccEnab line high and the serial buffer starts saving the data. The serial buffer holds 100000 samples. When the buffer captures more than 100000 points the end of memory is reached, the index is reset to 0, and any data in memory is written over. When data cannot be downloaded to the PC fast enough it gets overwritten in the buffer.

To simulate real acquisition for this example, noise is played out on output channel 1 from the same circuit. This should be fed back in to input channel 1 to test acquisition.

### Program Description

The Visual Basic program controls the continuous acquisition circuit described above. Buttons allow the user to start and stop acquisition. The number of samples acquired is displayed while acquisition is taking place. The data is written to an output file "C:\TDT\ActiveX\ActXExamples\vb\VB2005\tones.dat". An ActiveX control is used for the RP2 device. A Timer control is used to read the buffer index.

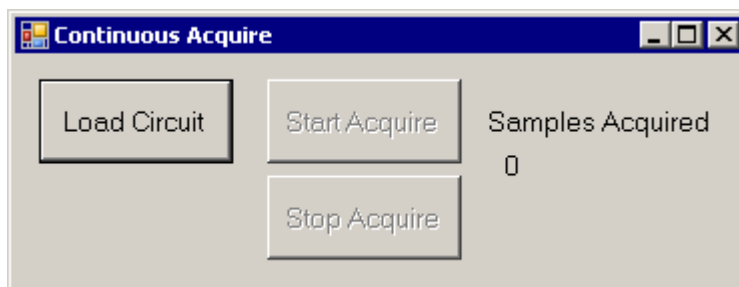

### Relevant Code

The code below is run when the user clicks on the Start Acquire button. It enables the acquisition by performing a software trigger.

```
bAcquire = True
bSecondHalf = False
RP.SoftTrg(1) 'Starts cycle
```

The code below is run when acquisition is being performed. The buffer reads in the input stream of data and alternates between the first half of the buffer and the second half of the buffer. The data is written to a bytefile using the Write() command.

```
'Loop until half of buffer is full
If bSecondHalf Then
    While curindex > bufpts
        curindex = RP.GetTagVal("index")
    End While
Else
    While curindex < bufpts
        curindex = RP.GetTagVal("index")
    End While
End If
'Read half of data buffer
data = RP.ReadTagVEX("dataout",offset,bufpts,"F32","F32",1)
'Write singles to byte file
For i = 0 To data.Length - 1
    fWriter.Write(data(0, i))
Next
'Update samples label
samplesAcquired = samplesAcquired + bufpts
lblSamplesAcquired.Text = samplesAcquired
'Switch to other half of buffer
If bSecondHalf Then
    offset = 0
Else : offset = bufpts
End If
bSecondHalf = Not bSecondHalf
```

### VB2005 Example: Continuous Play

This example uses a circuit that continually plays data to an output channel from a 100,000 sample serial buffer at a rate of 100 kHz and a Visual Basic program that continually writes to the serial buffer in blocks of 50,000 samples.

#### ActiveX Methods Used

- [ConnectRP2](#)
- [SoftTrg](#)
- [GetTagVal](#)
- [LoadCOF](#)
- [GetTagSize](#)
- [WriteTagVEX](#)
- [Run](#)

#### Files Used

The executable file required for this example can be found in:  
*C:\TDT\ActiveX\ActXExamples\vb\VB2005\Continuous\_Play\bin\Release*

- Continuous\_Play.exe: compiled executable; for running the example without having to start up Visual Basic

The source files used to create this example can be found in:

*C:\TDT\ActiveX\ActXExamples\vb\VB2005\Continuous\_Play*

- frmCPMain.vb: contains an ActiveX component for the RP2
- frmCPMain.Designer.vb: Visual Basic form; includes graphical interface and VB code

The RPvdsEx file used can be found in: *C:\TDT\ActiveX\ActXExamples\RP\_files*

- Continuous\_Play.rcx: RPvdsEx file needed to run the VB code on the RP2

## Required Hardware

- RP2

## Required Applications

- RPvdsEx
- Visual Basic

## Running the Application

Run the Continuous\_Play.exe executable file from the Release directory, or load the Continuous\_Play.vbproj project into Visual Basic and run it from there.

## Making the RPvdsEx Circuit

### Required components for acquisition:

- Two parameter tags (ParTag). To change the name of a parameter tag, doubleclick the parameter and type a new name.
- datain - points to the memory buffer
- index - points to the index of the serial buffer
- Two software triggers (TrgIn, set to Soft1 and Soft2)
- Digital-to-analog converter (DacOut)
- RS flip-flop (RSFlipFlop)
- Serial buffer (SerialBuf). To change the size of the serial buffer's memory, double-click the component and change the value for Size to 100000 (for this example).

Connect the circuit as shown below. The RPx online help is accessible from within RPvdsEx if it is required.

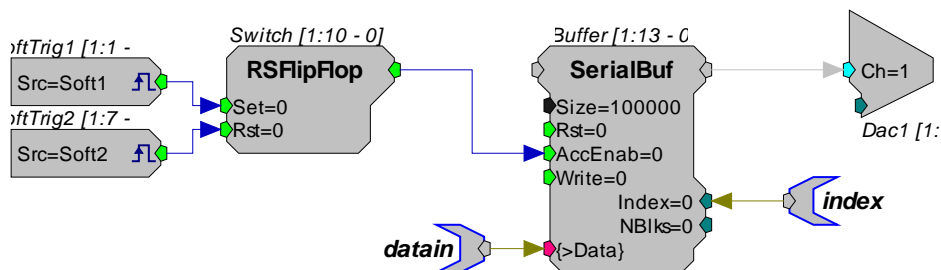

When software trigger 1 goes high the RSFlipFlop goes and stays high. This sets the AccEnab line high and the serial buffer starts sending the data out to the DAC. When the serial buffer has played out 100000 points the index is reset and the data at the beginning of the buffer is played out. As long as the AccEnab is high the Serial Buffer will play the signal.

## Program Description

The program plays a series of tones for 10 seconds. The first second of tones is loaded to the serial buffer. A software trigger starts the counter and the signal is played out through the DAC. The Serial buffer index is polled until 50,000 points are played from the buffer. Another tone is generated and loaded to the first half of the buffer. The counter is polled until the next 50,000 points are played out and the cycle is repeated. The program checks to see if the transfer rate is fast enough when the data is written to the buffer. A final software trigger ends the play out.

The interface to the program consists of only a single button, which starts the playing process, and a status label that shows runtime information. An ActiveX control is used for the RP2 device.



## Relevant Code

The code below contains the main playing loop. Each time through the loop, the tones are created at different frequencies. Upon clicking the Make Tones button the first time through, both halves of the buffer are written immediately, otherwise the tones are written to the first half of the buffer, then the second half is written to the buffer. Software trigger 2 terminates the play out.

```
'Create time array
For z = 0 To bufpts - 1
    t(z) = z / fs
Next
'Main loop
For n = 1 To 4
'Make signals
    For z = 0 To bufpts - 1
        tone1(z) = CSng(Math.Sin(2 * Math.PI * t(z) * freq1))
        tone2(z) = CSng(Math.Sin(2 * Math.PI * t(z) * freq2))
    Next z
    'Change frequencies for next loop
    freq1 = freq1 + 1000
    freq2 = freq2 + 1000
    If n = 1 Then
        'Write to both halves of buffer first time through
        RP.WriteTagVEX("datain", 0, "F32", tone1)
        RP.WriteTagVEX("datain", bufpts, "F32", tone2)
        RP.SoftTrg(1)
```

The code shown below waits until the first half of the buffer is done playing, then writes the new tone to the first half of the buffer while the second half is being played. Then it ensures that the data was written to the buffer fast enough (otherwise the output is unreliable because the index buffer keeps looping continuously). After that, it waits until the second half is done playing, and then writes the new tone to the second half of the buffer. Again, the transfer rate is checked.

```
'Update current index
curindex = RP.GetTagVal("index")
lblStatus.Text = "current index: " & curindex
Application.DoEvents()
'Loop through first half
While curindex < bufpts
    curindex = RP.GetTagVal("index")
End While
'Write to first half of buffer
RP.WriteTagVEX("datain", 0, "F32", tone1)
```



```

'Update current index
curindex = RP.GetTagVal("index")
lblStatus.Text = "current index: " & curindex
Application.DoEvents()
'Check transfer rate
If curindex < bufpts Then
    MsgBox "Transfer rate too slow"
    RP.SoftTrg(2)
    Exit Sub
End If
'Loop through second half
While curindex > bufpts
    curindex = RP.GetTagVal("index")
End While
'Write to second half of buffer
RP.WriteTagVEX("datain", bufpts, "F32", tone2)
'Update current index
curindex = RP.GetTagVal("index")
lblStatus.Text = "current index: " & curindex
Application.DoEvents()
'Check transfer rate
If curindex > bufpts Then
    MsgBox "Transfer rate too slow"
    RP.SoftTrg(2)

```

## VB2005 Example: Two Channel Acquisition

This example uses a circuit that continuously acquires data from two channels at 100 kHz per channel into a serial buffer and a Visual Basic program that continually reads from the serial buffer in blocks of 50,000 samples and saves the data to disk.

### ActiveX Methods Used

- [ConnectRP2](#)
- [Run](#)
- [GetTagVal](#)
- [ClearCOF](#)
- [GetStatus](#)
- [ReadTagVEX](#)
- [LoadCOF](#)
- [SoftTrg](#)

### Files Used

The executable file required for this example can be found in:

*C:\TDT\ActiveX\ActXExamples\vb\VB2005\TwoCh\_Continuous\_Acquire\bin\Release*

- TwoCh\_Continuous\_Acquire.exe: compiled executable; for running the example without having to start up Visual Basic

The source files used to create this example can be found in:

*C:\TDT\ActiveX\ActXExamples\vb\VB2005\TwoCh\_Continuous\_Acquire*

- frmTAMain.vb: contains an ActiveX component for the RP2
- frmTAMain.Designer.vb: Visual Basic form; includes graphical interface and VB code

The RPvdsEx file used can be found in: *C:\TDT\ActiveX\ActXExamples\RP\_files*

- TwoCh\_Continuous\_Acquire.rcx: RPvdsEx file needed to run the VB code on the RP2

### Required Hardware

- RP2

### Required Applications

- RPvdsEx
- Visual Basic

### Running the Application

- Run the TwoCh\_Continuous\_Acquire.exe executable file from the Release directory, or load the TwoCh\_Continuous\_Acquire.vbproj project into Visual Basic and run it from there.

### Making the RPvdsEx Circuit

#### Required components for acquisition:

- Two parameter tags (ParTag). To change the name of a parameter tag, double-click the parameter and type a new name.
  - dataout - points to the memory buffer
  - index - points to the index of the serial buffer
- Two software triggers (TrgIn, set to Soft1 and Soft2)
- Two analog-to-digital converters (AdcIn)
- A converter that takes two 32-bit floating point values and compresses them into a single 32-bit word, as two 16-bit integers (ShufTo16)
- RS flip-flop (RSFlipFlop)
- Serial buffer (SerialBuf). To change the size of the serial buffer's memory, double-click on the component and change the value for Size to 100000 (for this example).

Connect the circuit as shown below. The RPx online help is accessible from within RPvdsEx if it is required.

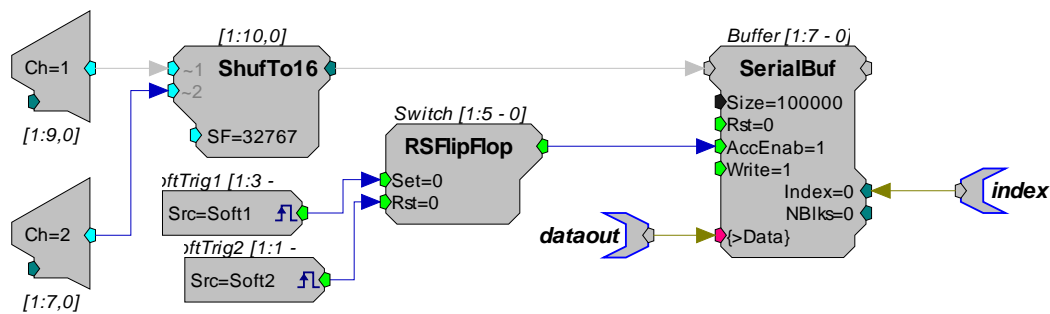

The circuit uses two AdcIns and a ShufTo16 component to acquire two channels of data continuously at 100kHz sampling rate. The signal is captured to a SerialBuffer, whose data is downloaded to the PC and stored in a file by the Visual Basic program. The first software trigger starts acquisition and the second software trigger halts acquisition.

Note: This circuit contains a Gaussian noise generator that sends its output to Channel 1 of the DAC and a tone that sends its output to Channel 2 of the DAC. These are used for simulating acquisition (feed the output channels back into the input channels of the same RP2 device).

## Program Description

The program acquires a signal from two channels at 100 kHz sampling rate and stores it in a file. A software trigger starts the counter and a signal is stored in the serial buffer. The counter is polled until 50,000 points are read into the buffer. The data is then stored in an array, which is written to a data file. The counter is polled until the next 50,000 points are read and the cycle is repeated. Each time the data is sent to the PC the program checks to see if the transfer rate is fast enough. A final software trigger ends the data acquisition. The interface to the program consists of a button to load the circuit and a button to start acquisition. Acquisition runs until the Stop Acquire button is pressed. The program also displays the amount of samples acquired while acquisition is taking place. An ActiveX control is used for the RP2 device. A timer is used to poll the buffer index and read the data if it is necessary based on the index. The data is written to an output file "C:\TDT\ActiveX\ActXExamples\vb\VB2005\2CHtones.dat"

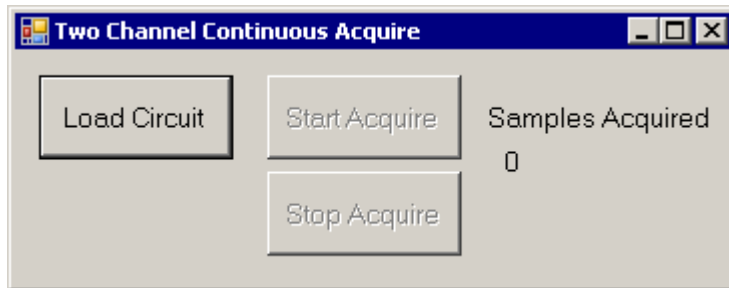

## Relevant Code

The code below controls reading from the first half of the buffer. The ReadTagVEX() function is used to read the data and uncompress it back into the original floating-point values.

```
'loop until half of buffer is full
If bSecondHalf Then
    While curindex > bufpts
        curindex = RP.GetTagVal("index")
    End While
Else
    While curindex < bufpts
        curindex = RP.GetTagVal("index")
    End While
End If
'read half of data buffer
dataInt = RP.ReadTagVEX("dataout",offset,bufpts,"I16","I16",2)
For i = 0 To dataInt.Length / 2 - 1
    dataSng(0, i) = dataInt(0, i) / 32767
    dataSng(1, i) = dataInt(1, i) / 32767
Next
'write interlaced singles to byte file
For i = 0 To dataSng.Length / 2 - 1
    fWriter.Write(dataSng(0, i))
    fWriter.Write(dataSng(1, i))
Next
update samples label
samplesAcquired = samplesAcquired + bufpts
lblSamplesAcquired.Text = samplesAcquired
```

The code for the second half of the buffer is very similar, but also includes a check to see if the data transfer is fast enough.

## VB2005 Example: Two Channel Play

This example uses a circuit that continuously plays a signal out of two channels at 100 kHz per channel and a Visual Basic program that continuously writes to a serial buffer in 50,000 sample chunks.

### ActiveX Methods Used

- [WriteTagVEX](#)
- [SoftTrg](#)
- [GetTagVal](#)

### Files Used

The executable file required for this example can be found in:

*C:\TDT\ActiveX\ActXExamples\vb\VB2005\TwoCh\_Continuous\_Play\bin\Release*

- TwoCh\_Continuous\_Play.exe: compiled executable; for running the example without having to start up Visual Basic

The source files used to create this example can be found in:

*C:\TDT\ActiveX\ActXExamples\vb\VB2005\TwoCh\_Continuous\_Play*

- frmTPMain.vb: contains an ActiveX component for the RP2
- frmTPMain.Designer.vb: Visual Basic form; includes graphical interface and VB code

The RPvdsEx file used can be found in: *C:\TDT\ActiveX\ActXExamples\RP\_files*

- TwoCh\_Continuous\_Play.rcx: RPvdsEx file needed to run the VB code on the RP2

### Required Hardware

- RP2

### Required Applications

- RPvdsEx
- Visual Basic

### Running the Application

- Run the TwoCh\_Continuous\_Play.exe executable file from the Release directory, or load the TwoCh\_Continuous\_Play.vbproj project into Visual Basic and run it from there.

### Making the RPvdsEx Circuit

#### *Component types required:*

- Two parameter tags: To change the name of a parameter tag, double-click it then type a new name.
  - datain - Points to the memory buffer
  - index - Points to the index of the serial buffer.
- Two software triggers (Soft1 and Soft2). To change the trigger to soft trigger, double-click on the trigger and click on the drop down menu under Trigger Type. Change one to Soft1 and the other to Soft2.
- Two DACs
- RSFlipFlop
- SplitFrom16

- A serial buffer (SerialBuf). To change the size of the serial buffer's memory, double-click the component and change the Size to 100000.

Connect the circuit as shown below. The RPx online help is accessible from within RPsVdsEx if it is required.

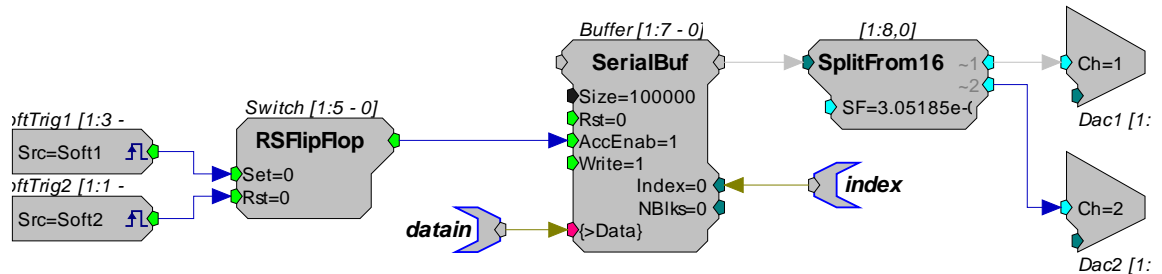

The circuit below uses a SerialBuf and SplitFrom16 to play out signals to two channels continuously. The signal is generated on the PC and then loaded into the serial buffer memory.

The circuit is similar to the Continuous Play example. When Soft Trigger 1 goes high the FlipFlop goes high and stays high. This sets the AccEnab line high and the serial buffer starts sending the data out to the DAC. When the serial buffer has played out 100000 points, the index is reset and the data at the beginning of the buffer is played out. As long as the AccEnab is high the serial buffer will play the signal. The signal from the serial buffer memory is split into two channels with SplitFrom16 and both channels are played out on DAC OUT-1 and DAC OUT-2.

### Program Description

This program generates two tones and loads them to the serial buffer's memory with WriteTagVEX. The general format for generating the signal with WriteTagVEX is shown below. A status display shows the current signal buffer index. Otherwise, this example is similar to Continuous Play.



### Relevant Code

The signals must be generated for WriteTagVEX and SplitFrom16. For SplitFrom16 the format must be 16-bit integer. The scaling factor determines the amplitude of the signal; in this case the scaling factor assumes a +/- 1.0 V signal. The code below generates the two tones and uses a looping structure to create sets of tones with different frequencies.

```
'Create time array
For z = 0 To bufpts - 1
    t(z) = z / fs
Next
Dim freq1 As Double = 500 'Initial frequency of first tone
Dim freq2 As Double = 2000 'Initial frequency of second tone
Dim freq3 As Double = freq1 + 500
Dim freq4 As Double = freq2 + 1000
'Main loop
For n = 1 To 5
    'Make signals
    For z = 0 To bufpts - 1
        tones1(0, z) = Round(Sin(2 * PI * t(z) * freq3) * 32760)
```

```

tones1(1, z) = Round(Sin(2 * PI * t(z) * freq4) * 32760)
tones2(0, z) = Round(Sin(2 * PI * t(z) * freq1) * 32760)
tones2(1, z) = Round(Sin(2 * PI * t(z) * freq2) * 32760)
Next z
'Change frequencies for next loop
freq3 = freq1 + 1000
freq4 = freq2 + 1000
freq1 = freq1 + 500
freq2 = freq2 + 500

```

The signals are loaded with WriteTagVEX. The format below with 'I16' indicates 16-bit integer format. WriteTagVEX determines the properties of the variant used for signal generation. After loading, the signals are then played out using the soft trigger.

```

If n = 1 Then
'Write to both halves of buffer first time through
RP.WriteTagVEX("datain", 0, "I16", tones1)
RP.WriteTagVEX("datain", bufpts, "I16", tones2)
RP.SoftTrg(1)
Else
'Update current index
curindex = RP.GetTagVal("index")
lblStatus.Text = "current index: " & curindex
Application.DoEvents()
'Loop through first half
While curindex < bufpts
curindex = RP.GetTagVal("index")
End While
'Write to first half of buffer
RP.WriteTagVEX("datain", 0, "I16", tones1)
'Update current index
curindex = RP.GetTagVal("index")
lblStatus.Text = "current index: " & curindex
Application.DoEvents()
'Check transfer rate
If curindex < bufpts Then
MsgBox "Transfer rate too slow"
RP.SoftTrg(2)
Exit Sub
End If
'Loop through second half
While curindex > bufpts
curindex = RP.GetTagVal("index")
End While
'Write to second half of buffer
RP.WriteTagVEX("datain", bufpts, "I16", tones2)
'Update current index
curindex = RP.GetTagVal("index")
lblStatus.Text = "current index: " & curindex
Application.DoEvents()

```

## VB2005 Example: Read Data

This example uses a FileStream object to read either the tones.dat file created from running the Continuous\_Acquire example or the 2Chtones.dat file created from running the TwoCh\_Continuous\_Acquire example and stores it into a buffer for data processing. This example illustrates how data may be made available for analysis after it has been acquired and stored.

## ActiveX Methods Used

No ActiveX methods are required to read the FileStream object. The code provided in this example is to be used as a reference for reading stored data.

## Files Used

The executable file required for this example can be found in:

*C:\TDT\ActiveX\ActXExamples\vb\VB2005\Read\_Data\bin\Release*

- Read\_Data.exe: compiled executable; for running the example without having to start up Visual Basic

The source files used to create this example can be found in:

*C:\TDT\ActiveX\ActXExamples\vb\VB2005\Read\_Data*

- frmRDMain.vb: contains a subroutine for reading a .dat file into a buffer
- frmRDMain.Designer.vb: Visual Basic form; includes graphical interface and VB code

## Required Hardware

- None

## Required Applications

- Visual Basic

## Required Files

- tones.dat (created from running Continuous\_Acquire.exe)
- 2CHtones.dat (created from running TwoCh\_Continuous\_Acquire.exe)

## Running the Application

- Run the Read\_Data.exe executable file from the Release directory, or load the Read\_Data.vbproj project into Visual Basic and run it from there.

## Program Description

The program creates a FileStream to read in the binary data recorded by the Continuous\_Acquire example ("tones.dat") or the TwoCh\_Continuous\_Acquire example (2CHtones.dat) and load it into a buffer for processing. The program has one button, which is used to initiate the file read and store as well as a drop down list to select which file to read.



## Relevant Code

The code below initializes the FileStream and reads the binary data file. It then writes the data read into a data array buffer.

```

    Dim fs1 As New FileStream
    ("C:\TDT\ActiveX\ActXExamples\vb\VB2005\tones.dat",
    IO.FileMode.Open)
    Dim fs2 As New
    FileStream("C:\TDT\ActiveX\ActXExamples\vb\VB2005\2CHtones.dat"
    , IO.FileMode.Open)
    Dim fReader1 As BinaryReader
  
```

```

        Dim fReader2 As BinaryReader
        Dim numChans As Integer = 1
        Dim data1() As Single 'Buffer for importing one-channel
data
        Dim data2(,) As Single 'Buffer for importing two-channel
data
        numChans = CInt(cmbNumChan.Text)
        Dim i As Integer = 0
        Select Case numChans
        'Read either tones.dat or 2Chtones.dat
        Case 1
            ReDim data1(fReader1.BaseStream.Length / 4) '4 Bytes
per Single
            'Load all data in file to data array
            Do
                data1(i) = fReader1.ReadSingle()
                i += 1
            Loop While fReader1.BaseStream.Position <>
fReader1.BaseStream.Length
            fReader1.BaseStream.Position = 0
        Case 2
            ReDim data2(0 To 1, fReader2.BaseStream.Length / 8)
'Two rows, 4 bytes per Single
            Do
                data2(0, i) = fReader2.ReadSingle()
                data2(1, 0) = fReader2.ReadSingle()
                i += 1
            Loop While fReader2.BaseStream.Position <>
fReader2.BaseStream.Length
            fReader2.BaseStream.Position = 0
        End Select

```

## Visual Basic Examples – VB6

### VB6 Example: CircuitLoader

This example documents a Visual Basic program that lets the user load RPvdsEx control files (\*.rcx) and run them on Real-Time Processors. Up to 32 processors can be controlled at once by this program (up to 8 RP2/RP2.1s, up to 8 RA16s, up to 8 RV8s, and up to 8 RL2s).

#### ActiveX Methods Used

- [ConnectRP2](#)
- [LoadCOF](#)
- [GetStatus](#)
- [ClearCOF](#)
- [Run](#)
- [Halt](#)

#### Files Used

The files used by this example can be found in: *C:\TDT\ActiveX\ActXExamples\vb\VB6*

- Circuit\_Loader.vbp: Visual Basic project



- Circuit\_Loader.frm: Visual Basic form; includes graphical interface and VB code; contains ActiveX components for the processor devices
- Circuit\_Loader.exe: compiled executable; for running the example without having to start up Visual Basic

### Required Hardware

- At least one Real-Time Processor (either RP2, RP2.1, RA16, RV8, or RL2)

### Required Applications

- Visual Basic

### Running the Application

- Run the Circuit\_Loader.exe executable file from the VB6 directory, or load the Circuit\_Loader.vbp project into Visual Basic and run it from there.

### Program Description

The Visual Basic program presents a graphical interface through which the user can load various circuits to Real-Time Processors. The user selects the type of processor device, the interface (USB or Gigabit), and the device number (from 1 to 8) through radio buttons and input boxes. When the Load Circuit button is clicked, a CommonDialog control lets the user choose the \*.rcx file, and then it is loaded to the correct device based on the current settings of the user interface. A label is updated to show whether the circuit was loaded successfully or if an error occurred. 32 ActiveX controls are used in the program, one for each device that can potentially be used.

### Relevant Code

The code below is run when the user clicks on the "Load Circuit" button. It displays a dialog window to select the \*.rcx file, connects to the appropriate Real-Time Processor device, and loads and runs the circuit.

```
'Opens a control to select the *.rcx file
CommonDialog1.ShowOpen
'Saves the filepath to the appropriate file
filepath = CommonDialog1.FileName If Option1(0).Value = True
Then
    interface = "USB"
Else
    interface = "Gigabit"
End If
'The following code is run if the first radio button is
selected
'Connects using the correct interface and device number
If ModuleOption(0).Value = True Then
    RP2(DeviceSelection).ConnectRP2(interface, DeviceSelection)
    RP2(DeviceSelection).ClearCOF
    RP2(DeviceSelection).LoadCOF (filepath)
    RP2(DeviceSelection).Run
    Status = RP2(DeviceSelection).GetStatus
    device_type = "RP2"
```

The code is similar if the user selects an RA16 Medusa, RV8 Barracuda or RL2 Stingray module.

### VB6 Example: Band Limited Noise

This example uses a circuit that produces band-limited noise and a Visual Basic program that lets the user control filter and noise settings, start and stop playing, and view results.

### ActiveX Methods Used

- [ConnectRP2](#)
- [Run](#)
- [GetSFreq](#)
- [ClearCOF](#)
- [Halt](#)
- [GetCycUse](#)
- [LoadCOF](#)
- [SetTagVal](#)
- [GetStatus](#)
- [GetTagVal](#)

### Files Used

The files used by this example can be found in: *C:\TDT\ActiveX\ActXExamples\vb\VB6*

- *Band\_Limited\_Noise.vbp*: Visual Basic project
- *Band\_Limited\_Noise.frm*: Visual Basic form; includes graphical interface and VB code; contains an ActiveX component for the RP2
- *Band\_Limited\_Noise.exe*: compiled executable; for running the example without having to start up Visual Basic

The RPvdsEx file used can be found in: *C:\TDT\ActiveX\ActXExamples\RP\_files*

- *Band\_Limited\_Noise.rcx*: Control File of the RPvdsEx designed circuit

### Required Hardware

- RP2

### Required Applications

- RPvdsEx
- Visual Basic

### Running the Application

Run the *Band\_Limited\_Noise.exe* executable file from the VB6 directory, or load the *Band\_Limited\_Noise.vbp* project into Visual Basic and run it from there.

### Making the RPvdsEx Circuit

#### *Required components:*

- Six parameter tags (ParTag). To change the name of a parameter tag, double-click on the parameter and type a new name.
  - Gain - increases the relative bandpass filtering in dB
  - Freq - center frequency of the bandpass filter
  - BW - width of the bandpass filter (3 dB rolloff)
  - Amp - changes the amplitude of the noise
  - Enable - toggles generation of the filter coefficients
  - Clip - checks to see whether the signal was clipped or not

- Gaussian noise generator (GaussNoise)
- Parametric filter coefficient generator (ParaCoef)
- Biquad filter (Biquad)
- Feature search (FeatSrch)
- Schmitt trigger (Schmitt)
- Digital-to-analog converter (DacOut)
- Digital bit output (BitOut)

Connect the circuit as shown below. The online help is accessible from within RPvdsEx if it is required. The two boxes represent the different parts of the circuit.

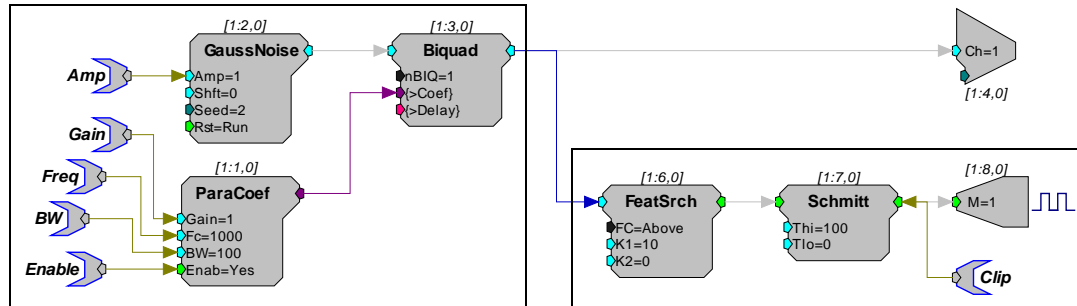

The box on the left has components that generate (GaussNoise) and filter (ParaCoef/Biquad) the waveform. The parameter tags are used to set the amplitude of the noise and filter parameters. The second part of the circuit (box on right) checks for clipping (signal values greater than +/- 10 volts) and generates a high signal on Bit 0 (M=1) of the processor device.

### Program Description

The program controls a circuit that generates band-limited noise. Buttons allow the user to load the circuit and start and stop playing of the noise. Through input boxes, the user controls the center frequency, bandwidth, filter gain, coefficient generation, and the intensity of the filtered noise. The sample rate and cycle usage are displayed, along with a checkbox that is marked if the parameters produce clipping. The relevant code controls or receives information about the circuit through parameter tags. An ActiveX control is used for the RP2 device, and a Timer control is used for monitoring the cycle usage of the circuit and clipping status.

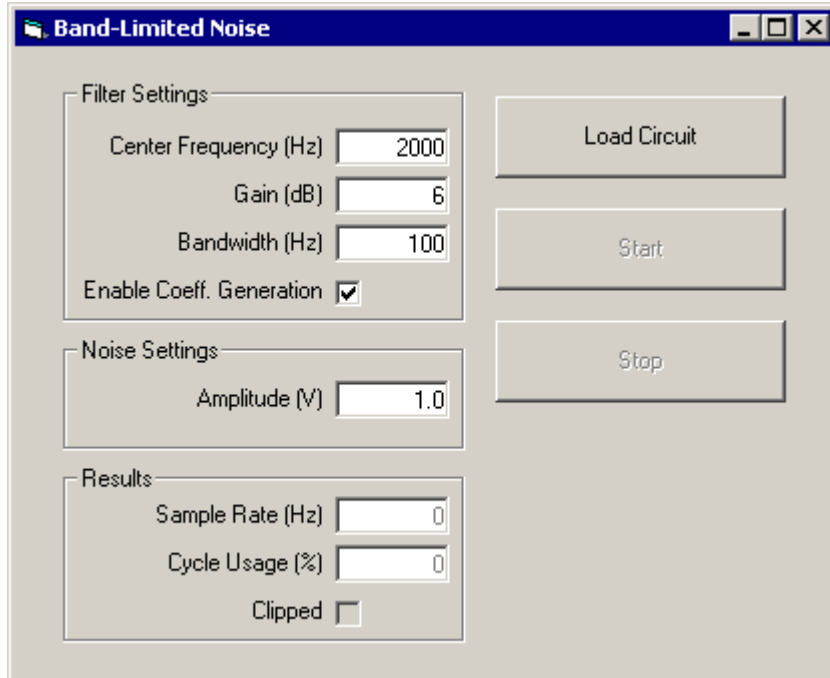

### Relevant Code

The code below is run when the user clicks on the "Load Circuit" button. It connects to the RP2, loads the circuit, and makes sure everything was loaded successfully.

```
'Tries to connect through the Gbit interface
If RP2.ConnectRP2("GB", 1) = 0 Then
  If RP2.ConnectRP2("USB", 1) = 0 Then
    'Displays a message if not connected
    MsgBox "Error connecting to RP2"
  End If
End If
RP2.ClearCOF 'Clears any circuit on the processor device
RP2.LoadCOF("C:\TDT\ActiveX\ActXExamples\RP_files\Band_Limited_Noise.rcx")
Status = RP2.GetStatus 'Gets the device status
If (Status And 1) = 0 Then
  MsgBox "Error connecting to RP2; status: " & Status
  RP2.Halt
ElseIf (Status And 2) = 0 Then
  MsgBox "Error loading circuit; status: " & Status
  RP2.Halt
```

The code below is run when the user clicks on the "Start Circuit" button. It sets the values of each parameter based on the values in the input boxes of the graphical interface. It then starts the circuit running, which plays the noise out of the RP2 on output channel OUT-1.

```
RP2.SetTagVal("Amp", AmplitudeText.Text)
RP2.SetTagVal("Freq", CenterFreqText.Text)
RP2.SetTagVal("BW", BandwidthText.Text)
RP2.SetTagVal("Gain", GainText.Text)
RP2.SetTagVal("Enable", EnableCheck.Value)
RP2.Run
```

The results (clipping detection and cycle usage display) are updated every 50 ms by a timer. This is done by the following code:

```
ClippedCheck.Value = RP2.GetTagVal("Clip")
CycUsageText.Text = RP2.GetCycUse
```

## VB6 Example: Continuous Acquire

This example uses a circuit that continually acquires data from an input channel into a 100,000 sample serial buffer at a rate of 100 kHz and a Visual Basic program that continually reads from the serial buffer in blocks of 50,000 samples and saves the data to a file.

### ActiveX Methods Used

- [ConnectRP2](#)
- [GetStatus](#)
- [GetTagVal](#)
- [SoftTrg](#)
- [Run](#)
- [ReadTag](#)
- [LoadCOF](#)
- [Halt](#)

### Files Used

The files used by this example can be found in: *C:\TDT\ActiveX\ActXExamples\vb\VB6*

- Continuous\_Acquire.vbp: Visual Basic project
- Continuous\_Acquire.frm: Visual Basic form; includes graphical interface and VB code; contains an ActiveX component for the RP2
- Continuous\_Acquire.exe: compiled executable; for running the example without having to start up Visual Basic

The RPvdsEx file used can be found in: *C:\TDT\ActiveX\ActXExamples\RP\_files*

- Continuous\_Acquire.rcx: Control File of the RPvdsEx designed circuit

### Required Hardware

- RP2

### Required Applications

- RPvdsEx
- Visual Basic

### Running the Application

- Run the Continuous\_Acquire.exe executable file from the VB6 directory, or load the Continuous\_Acquire.vbp project into Visual Basic and run it from there.

### Making the RPvdsEx Circuit

#### *Required components for acquisition:*

- Two parameter tags (ParTag). To change the name of a parameter tag, double-click the parameter and type a new name.
  - dataout - points to the memory buffer
  - index - points to the index of the serial buffer
- Two software triggers (TrgIn, set to Soft1 and Soft2)
- Analog-to-digital converter (AdcIn)

- RS flip-flop (RSFlipFlop)
- Serial buffer (SerialBuf). To change the size of the serial buffer's memory, double-click the component and change the value for Size to 100000 (for this example).

Connect the circuit as shown below. The RPx online help is accessible from within RPsEx if it is required.

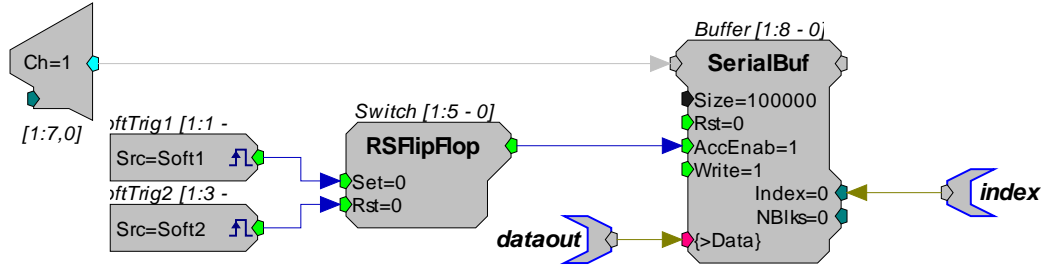

Data is continuously acquired on channel one but is only saved to the Serial buffer when the AccEnab line is set high. The two software triggers control the start and stop of the data acquisition. When Soft1 goes high the RSFlipFlop goes and stays high. This sets the AccEnab line high and the serial buffer starts saving the data. The serial buffer holds 100000 samples. When the buffer captures more than 100000 points the end of memory is reached, the index is reset to 0, and any data in memory is written over. When data cannot be downloaded to the PC fast enough it gets overwritten in the buffer.

To simulate real acquisition for this example, noise is played out on output channel 1 from the same circuit. This should be fed back in to input channel 1 to test acquisition.

### Program Description

The Visual Basic program controls the continuous acquisition circuit described above. Buttons allow the user to start and stop acquisition. The number of samples acquired is displayed while acquisition is taking place. The data is written to an output file "C:\TDT\ActiveX\ActXExamples\vb\VB6\tones.dat". An ActiveX control is used for the RP2 device. A Timer control is used to read the buffer index.

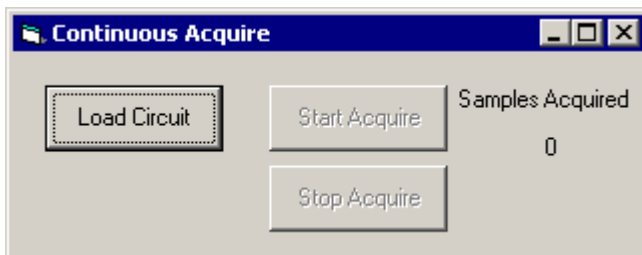

### Relevant Code

The code below is run when the user clicks on the Start Acquire button. It enables the timers and performs a software trigger to start acquisition.

```

If RunCircuit = True Then
    btnStart.Enabled = False
    Call RP.SoftTrg(1) 'Begins Cycle
    Timer1.Enabled = True
    iteration = 1
    txtIteration.Text = iteration
End If
    
```

The code below is runs continuously off the timer. It alternates between reading from the first half of the buffer and the second half of the buffer. The data is written to a file using the Put command.

```

If Acquire = True Then
    curindex = RPcoX1.GetTagVal("index")
    'High alternates between T and F to read from each half of
    the buffer
    If high Then
        While curindex > Bufpts
            curindex = RPcoX1.GetTagVal("index")
            SampleN.Caption = Samples_Acquired
        Wend
    Else
        While curindex < Bufpts
            curindex = RPcoX1.GetTagVal("index")
            SampleN.Caption = Samples_Acquired
        Wend
    End If
    error1 = RPcoX1.ReadTag("dataout", data(0), offset, bufpts)
    'Reads half of buffer
    If error1 = 0 Then
        MsgBox "error transferring data"
    End
    End If
    Put #1, , data()
    Samples_Acquired = Samples_Acquired + 50000 'Update caption

```

## VB6 Example: Continuous Play

This example uses a circuit that continually plays data to an output channel from a 100,000 sample serial buffer at a rate of 100 kHz and a Visual Basic program that continually writes to the serial buffer in blocks of 50,000 samples.

### ActiveX Methods Used

- [ConnectRP2](#)
- [SoftTrg](#)
- [GetTagVal](#)
- [LoadCOF](#)
- [GetTagSize](#)
- [WriteTag](#)
- [Run](#)

### Files Used

The files used by this example can be found in: *C:\TDT\ActiveX\ActXExamples\vb\VB6*

- Continuous\_Play.vbp: Visual Basic project
- Continuous\_Play.frm: Visual Basic form; includes graphical interface and VB code; contains an ActiveX component for the RP2
- Continuous\_Play.exe: compiled executable; for running the example without having to start up Visual Basic

The RPvdsEx file used can be found in: *C:\TDT\ActiveX\ActXExamples\RP\_files*

- Continuous\_Play.rcx: Control File of the RPvdsEx designed circuit

### Required Hardware

- RP2

## Required Applications

- RPvdsEx
- Visual Basic

## Running the Application

- Run the Continuous\_Play.exe executable file from the VB6 directory, or load the Continuous\_Play.vbp project into Visual Basic and run it from there.

## Making the RPvdsEx Circuit

### Required components for acquisition:

- Two parameter tags (ParTag). To change the name of a parameter tag, doubleclick the parameter and type a new name.
  - datain - points to the memory buffer
  - index - points to the index of the serial buffer
- Two software triggers (TrgIn, set to Soft1 and Soft2)
- Digital-to-analog converter (DacOut)
- RS flip-flop (RSFlipFlop)
- Serial buffer (SerialBuf). To change the size of the serial buffer's memory, double-click the component and change the value for Size to 100000 (for this example).

Connect the circuit as shown below. The RPx online help is accessible from within RPvdsEx if it is required.

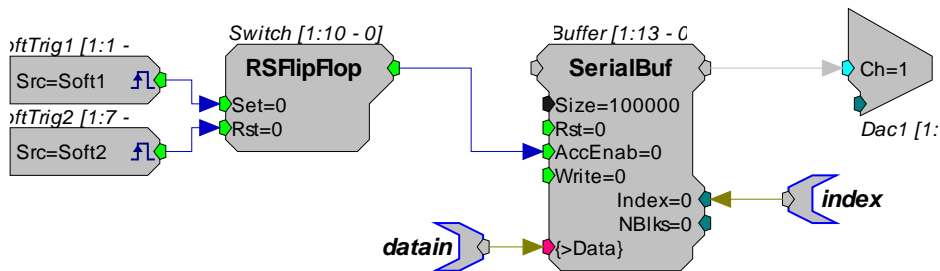

When software trigger 1 goes high the RSFlipFlop goes and stays high. This sets the AccEnab line high and the serial buffer starts sending the data out to the DAC. When the serial buffer has played out 100000 points the index is reset and the data at the beginning of the buffer is played out. As long as the AccEnab is high the Serial Buffer will play the signal.

## Program Description

The program plays a series of tones for 10 seconds. The first second of tones is loaded to the serial buffer. A software trigger starts the counter and the signal is played out through the DAC. The Serial buffer index is polled until 50,000 points are played from the buffer. Another tone is generated and loaded to the second half of the buffer. The counter is polled until the next 50,000 points are played out and the cycle is repeated. The program checks to see if the transfer rate is fast enough when the data is written to the buffer. A final software trigger ends the play out.

The interface to the program consists of only a single button, which starts the playing process. An ActiveX control is used for the RP2 device.





### Relevant Code

Each time through the main loop below, the tones are created at different frequencies. The first time through, the tones are written to the buffer immediately. Each time after that, the sendtones() subroutine is called. Software trigger 2 terminates the play out.

```

For n = 1 To 10
    freq1 = freq1 + 500
    freq2 = freq2 + 500
    For z = 0 To bufpts - 1
        tone1(z) = Round(Sin(2 * PI * t(z) * freq1))
        tone2(z) = Round(Sin(2 * PI * t(z) * freq2))
    Next z
    If n = 1 Then
        err1 = RP.WriteTag("datain", tone1(0), 0, length)
        err2 = RP.WriteTag("datain", tone2(0), bufpts, length)
        RP.SoftTrg(1)
    Else: sendtones
    End If
Next n
RP.SoftTrg(2)

```

The code for the sendtones() subroutine is shown below. It waits until the first half of the buffer is done playing, then writes the new tone to the first half of the buffer while the second half is being played while ensuring that the data was written to the buffer fast enough (otherwise the output is unreliable because the index buffer keeps looping continuously). After that, it waits until the second half is done playing, and then writes the new tone to the second half of the buffer.

```

curindex = RP.GetTagVal("index")
While curindex < bufpts
    curindex = RP.GetTagVal("index")
Wend
err1 = RP.WriteTag("datain", tone1(0), 0, length)
curindex = RP.GetTagVal("index")
If curindex < bufpts Then
    MsgBox "Transfer rate too slow"
    RP.SoftTrg (2)
End
End If
curindex = RP.GetTagVal("index")
While curindex > bufpts
    curindex = RP.GetTagVal("index")
Wend
err1 = RP.WriteTag("datain", tone2(0), bufpts, length)
curindex = RP.GetTagVal("index")
If curindex > bufpts Then
    MsgBox "Transfer rate too slow"
    RP.SoftTrg (2)

```

### Visual Basic Example: Two Channel Acquisition

This example uses a circuit that continuously acquires data from two channels at 100 kHz per channel into a serial buffer and a Visual Basic program that continually reads from the serial buffer in blocks of 50,000 samples and saves the data to disk.

### ActiveX Methods Used

- [ConnectRP2](#)

- [Run](#)
- [GetTagVal](#)
- [ClearCOF](#)
- [GetStatus](#)
- [ReadTagVEX](#)
- [LoadCOF](#)
- [SoftTrg](#)

### Files Used

The files used by this example can be found in: *C:\TDT\ActiveX\ActXExamples\vb\VB6*

- TwoCh\_Continuous\_Acquire.vbp: Visual Basic project
- TwoCh\_Continuous\_Acquire.frm: Visual Basic form; includes graphical interface and VB code; contains an ActiveX component for the RP2
- TwoCh\_Continuous\_Acquire.exe: compiled executable; for running the example without having to start up Visual Basic

The RPvdsEx file used can be found in: *C:\TDT\ActiveX\ActXExamples\RP\_files*

- TwoCh\_Continuous\_Acquire.rcx: Control File of the RPvdsEx designed circuit

### Required Hardware

- RP2

### Required Applications

- RPvdsEx
- Visual Basic

### Running the Application

Run the TwoCh\_Continuous\_Acquire.exe executable file from the VB6 directory, or load the TwoCh\_Continuous\_Acquire.vbp project into Visual Basic and run it from there.

### Making the RPvdsEx Circuit

*Required components for acquisition:*

- Two parameter tags (ParTag). To change the name of a parameter tag, double-click the parameter and type a new name.
  - dataout - points to the memory buffer
  - index - points to the index of the serial buffer
- Two software triggers (TrgIn, set to Soft1 and Soft2)
- Two analog-to-digital converters (AdcIn)
- A converter that takes two 32-bit floating point values and compresses them into a single 32-bit word, as two 16-bit integers (ShufTo16)
- RS flip-flop (RSFlipFlop)
- Serial buffer (SerialBuf). To change the size of the serial buffer's memory, double-click on the component and change the value for Size to 100000 (for this example).

Connect the circuit as shown below. The RPx online help is accessible from within RPvdsEx if it is required.

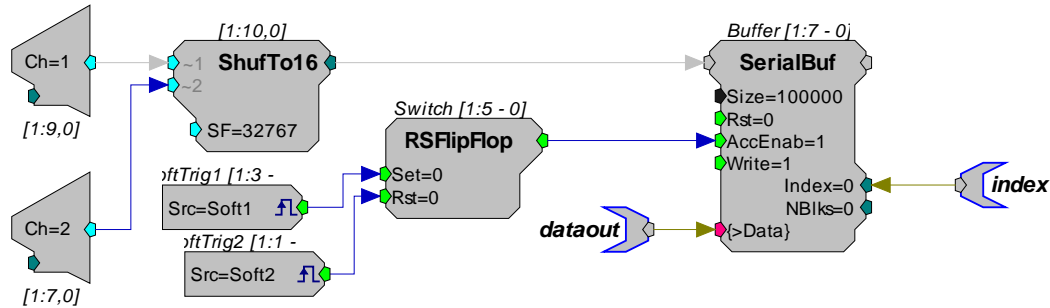

The circuit uses two AdcIns and a ShufTo16 component to acquire two channels of data continuously at 100kHz sampling rate. The signal is captured to a SerialBuffer, whose data is downloaded to the PC and stored in a file by the Visual Basic program. The first software trigger starts acquisition and the second software trigger halts acquisition.

**Note:** This circuit contains a Gaussian noise generator that sends its output to Channel 1 of the DAC and a tone that sends its output to Channel 2 of the DAC. These are used for simulating acquisition (feed the output channels back into the input channels of the same RP2 device).

### Program Description

The program acquires 10 seconds of signal from two channels at 100 kHz sampling rate and stores it in a file. A software trigger starts the counter and a signal is stored in the serial buffer. The counter is polled until 50,000 points are read into the buffer. The data is then stored in an array, which is written to a data file. The counter is polled until the next 50,000 points are read and the cycle is repeated. Each time the data is sent to the PC the program checks to see if the transfer rate is fast enough. A final software trigger ends the data acquisition.

The interface to the program consists of a button to load the circuit and a button to start acquisition. Acquisition runs for ten iterations before stopping. The program also displays the current iteration and current index of the serial buffer while acquisition is taking place. An ActiveX control is used for the RP2 device. A timer is used to poll the buffer index and read the data if it is necessary based on the index. The data is written to an output file "C:\TDT\ActiveX\ActXExamples\vb\VB6\2CHtones.dat"

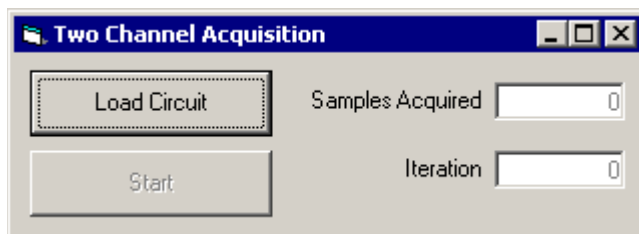

### Relevant Code

The code below controls reading from the first half of the buffer. The ReadTagVEX() function is used to read the data and uncompress it back into the original floating-point values.

```
Data = RP2.ReadTagVEX("dataout", 0, Bufpts, "I16", "F64", 2)
Put #1, , Data
CurrentIndex = RP2.GetTagVal("index")
CurrentIndexBox.Text = CurrentIndex
If CurrentIndex < Bufpts Then
    MsgBox "Transfer rate too slow; output data may contain
errors"
End If
Timer2.Enabled = True
```

The code for the second half of the buffer is very similar, but also includes a check to see if data transfer is fast enough.

## VB6 Example: Two Channel Play

This example uses a circuit that continuously plays a signal out of two channels at 100 kHz per channel and a Visual Basic program that continuously writes to a serial buffer in 50,000 sample chunks.

### ActiveX Methods Used

- [WriteTagVEX](#)
- [SoftTrg](#)
- [GetTagVal](#)

### Files Used

The files used by this example can be found in: *C:\TDT\ActiveX\ActXExamples\vb\VB6*

- TwoCh\_Continuous\_Play.vbp: Visual Basic project
- TwoCh\_Continuous\_Play.frm: Visual Basic form; includes graphical interface and VB code; contains an ActiveX component for the RP2
- TwoCh\_Continuous\_Play.exe: compiled executable; for running the example without having to start up Visual Basic

The RpvdsEx file used can be found in: *C:\TDT\ActiveX\ActXExamples\RP\_files*

- TwoCh\_Continuous\_Play.rcx: Control File of the RpvdsEx designed circuit

### Required Hardware

- RP2

### Required Applications

- RpvdsEx
- Visual Basic

### Running the Application

- Run the TwoCh\_Continuous\_Play.exe executable file from the VB6 directory, or load the TwoCh\_Continuous\_Play.vbp project into Visual Basic and run it from there.

### Making the RpvdsEx Circuit

#### *Component types required:*

- Two parameter tags: To change the name of a parameter tag, double-click it then type a new name.
  - datain - points to the memory buffer
  - index - points to the index of the serial buffer.
- Two software triggers (Soft1 and Soft2). To change the trigger to soft trigger, double-click on the trigger and click on the drop down menu under Trigger Type. Change one to Soft1 and the other to Soft2.
- Two DacOuts

- RSFlipFlop
- SplitFrom16
- A serial buffer (SerialBuf). To change the size of the serial buffer's memory, double-click the component and change the Size to 100000.

Connect the circuit as shown below. The RPx online help is accessible from within RPvdsEx if it is required.

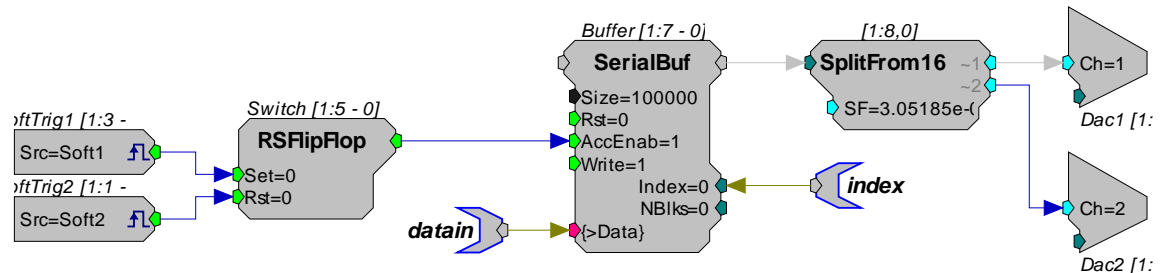

The circuit below uses a SerialBuf and SplitFrom16 to play out signals to two channels continuously. The signal is generated on the PC and then loaded into the serial buffer memory.

The circuit is similar to the Continuous Play example. When Soft Trigger 1 goes high the FlipFlop goes high and stays high. This sets the AccEnab line high and the serial buffer starts sending the data out to the DAC. When the serial buffer has played out 100000 points, the index is reset and the data at the beginning of the buffer is played out. As long as the AccEnab is high the serial buffer will play the signal. The signal from the serial buffer memory is split into two channels with SplitFrom16 and both channels are played out on DAC OUT-1 and DAC OUT-2.

### Program Description

This program generates two tones and loads them to the serial buffer's memory with WriteTagVEX. The general format for generating the signal with WriteTagVEX is shown below. Otherwise, this example is similar to Continuous Play.



### Relevant Code

The signals must be generated for WriteTagVEX and SplitFrom16. For SplitFrom16 the format must be 16-bit integer. The scaling factor determines the amplitude of the signal; in this case the scaling factor assumes a +/- 1.0 V signal. The code below generates the two tones and uses a looping structure to create sets of tones with different frequencies.

```

bufpts = RP.GetTagSize("datain") / 2
ReDim t(bufpts - 1)
ReDim tones1(0 To 1, bufpts - 1)
ReDim tones2(0 To 1, bufpts - 1)

freq1 = 500
freq2 = 2000
fs = 97656.25
'Load time array
For z = 0 To bufpts - 1
    t(z) = z / fs
Next z
'Main loop
For n = 1 To 5

```

```

freq3 = freq1 + 1000
freq4 = freq2 + 1000
freq1 = freq1 + 500
freq2 = freq2 + 500
'Generate tone signals
For z = 0 To bufpts - 1
    tones1(0, z) = Round(Sin(2 * PI * t(z) * freq3) * 32760)
    tones1(1, z) = Round(Sin(2 * PI * t(z) * freq4) * 32760)
    tones2(0, z) = Round(Sin(2 * PI * t(z) * freq1) * 32760)
    tones2(1, z) = Round(Sin(2 * PI * t(z) * freq2) * 32760)
Next z

```

The signals are loaded with WriteTagVEX. The format below with 'I16' indicates 16-bit integer format. WriteTagVEX determines the properties of the variant used for signal generation. After loading, the signals are then played out using the soft trigger.

```

'write to buffer
If n = 1 Then
    'Write to entire buffer first time through
    err1 = RP.WriteTagVEX("datain", 0, "I16", tones1())
    err2 = RP.WriteTagVEX("datain", bufpts, "I16", tones2())
    'Begin playing
    RP.SoftTrg(1)

```

## VB6 Example: Read Data

This example uses a DataFile object to read either the tones.dat file created from running the Continuous\_Acquire example or the 2Chtones.dat file created from running the TwoCh\_Continuous\_Acquire example and stores it into a buffer for data processing. This example illustrates how data may be made available for analysis after it has been acquired and stored.

### ActiveX Methods Used

No ActiveX methods are required to read the DataFile object. The code provided in this example is to be used as a reference for reading stored data.

### Files Used

The files used by this example can be found in: *C:\TDT\ActiveX\ActXExamples\vb\VB6*

- Read\_Data.vbp: Visual Basic project
- Read\_Data.frm: Visual Basic form; includes graphical interface and VB code; contains an ActiveX component for the RP2
- Read\_Data.exe: compiled executable; for running the example without having to start up Visual Basic

### Required Hardware

- None

### Required Applications

- Visual Basic
- Required Files
- tones.dat (created from running Continuous\_Acquire.exe)
- 2CHtones.dat (created from running TwoCh\_Continuous\_Acquire.exe)

## Running the Application

- Run the Read\_Data.exe executable file from the VB6 directory, or load the Read\_Data.vbp project into Visual Basic and run it from there.

## Program Description

The program creates a FileStream to read in the binary data recorded by the Continuous\_Acquire example ("tones.dat") or the TwoCh\_Continuous\_Acquire example ("2CHtones.dat") and load it into a buffer for processing. The program has one button, which is used to initiate the file read, as well as a drop down list to select which file to read.

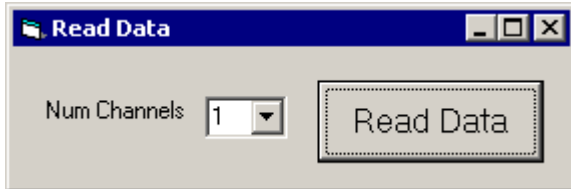

## Relevant Code

The code below initializes the DataStream and reads the binary data file. It then writes the data read into a data array buffer.

```

Const DataFile1 =
"C:\TDT\ActiveX\ActXExamples\vb\VB6\tones.dat"
Const DataFile2 =
"C:\TDT\ActiveX\ActXExamples\vb\VB6\2CHtones.dat"
Dim data1() As Single 'Buffer for holding one-channel data
Dim data2() As Single 'Buffer for holding two-channel data
Dim temp As Single
Dim lByteLen1 As Long 'Length of one-channel file
Dim lByteLen2 As Long 'Length of two-channel file
Dim numChan As Integer 'Number of channels in data
'Open files for reading
iFile1 = FreeFile
Open DataFile1 For Binary As iFile1
lByteLen1 = LOF(iFile1)
iFile2 = FreeFile
Open DataFile2 For Binary As iFile2
lByteLen2 = LOF(iFile2)
'Read either tones.dat or 2Chtones.dat
Select Case numChan
Case 1
'4 bytes per single
'Write data file to data array
ReDim data1(lByteLen1 / 4 - 1)
Get iFile1, , data1()
Seek iFile1, 1
Case 2
'Two channels, 4 bytes per single
'Write data file to data array
ReDim data2(0 To 1, lByteLen2 / 8 - 1)
For i = 0 To lByteLen2 / 8 - 1
Get iFile2, , temp
data2(0, i) = temp
Get iFile2, , temp
data2(1, i) = temp
Next
Seek iFile2, 1
End Select

```

## Visual C++ Examples

### Visual C++ Example: Circuit Loader

This example documents a Visual C++ program that lets the user load RpvdsEx control object files \*.RCO(\*.rco or \*.rcx) and run them on Real-Time Processors. Up to 32 processors can be controlled at once by this program (up to 8 RP2/RP2.1s, up to 8 RA16s, up to 8 RV8s, and up to 8 RL2s).

#### ActiveX Methods Used

- [ConnectRP2](#)
- [LoadCOF](#)
- [GetStatus](#)
- [ClearCOF](#)
- [Run](#)
- [Halt](#)

#### Files Used

The files required for this example can be found in:

*C:\TDT\ActiveX\ActXExamples\vc++\CircuitLoader*

- CircuitLoader.vcproj: Visual C++ project file
- CircuitLoaderDlg.cpp: Visual C++ code that controls the graphical user interface and communicates with the RpvdsEx circuit; contains ActiveX components for the processor devices
- CircuitLoader.exe: compiled executable; for running the example without having to start up Visual C++

#### Required Hardware

- At least one Real-Time Processor (either RP2, RP2.1, RA16, RV8, or RL2)

#### Required Applications

- Visual C++

#### Running the Application

- Run the CircuitLoader.exe executable file from the CircuitLoader directory, or load the CircuitLoader.vcproj project into Visual C++ and compile and run it from there.

#### Program Description

The Visual C++ program presents a graphical interface through which the user can load various circuits to Real-Time processors. The user selects the type of processor device, the interface (USB or Gigabit), and the device number (from 1 to 8) through radio buttons and input boxes. When the Load Circuit button is clicked, a CommonDialog control lets the user choose the \*.rcx file, and then it is loaded to the correct device based on the current settings of the user interface. A label is



updated to show whether the circuit was loaded successfully or if an error occurred. 32 ActiveX controls are used in the program, one for each device that can potentially be used.

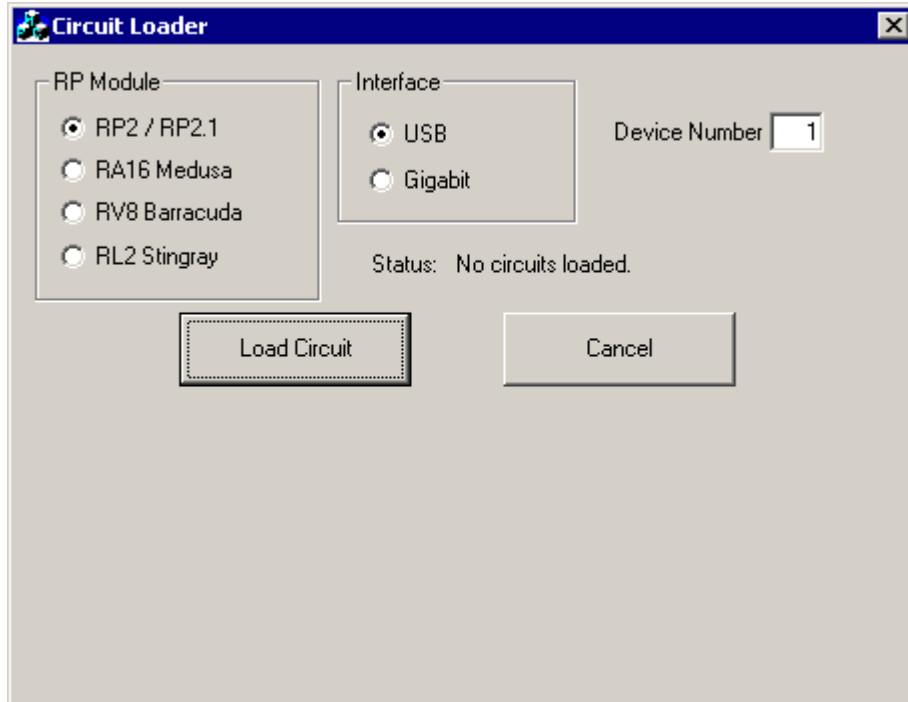

### Relevant Code

The code below is run when the user clicks on the "Load Circuit" button. It displays a dialog window to select the \*.rcx file, and then connects to the appropriate processor device, and loads and runs the circuit.

```

m_openfile_dialog.ShowOpen();
CString filepath = m_openfile_dialog.GetFileName();
CString interface_str;
switch(GetCheckedRadioButton(RADIO_USB, RADIO_GIGABIT)) {
    case RADIO_USB:
        interface_str = "USB";
        break;
    default:
        interface_str = "GIGABIT";
}
CString device_type;
int devnum = atoi(m_devnum_text);
long status;
switch(GetCheckedRadioButton(RADIO_RP2, RADIO_RL2)) {
    case RADIO_RP2:
        device_type = "RP2";
        break;
    case RADIO_RA16:
        device_type = "RA16";
        break;
    case RADIO_RV8:
        device_type = "RV8";
        break;
    default:
        device_type = "RL2";
}
status = RunCircuit(GetRP(device_type, devnum), filepath,
device_type, interface_str, devnum);

```

## Visual C++ Example: Band Limited Noise

This example uses a circuit that produces band-limited noise and a Visual C++ program that lets the user control filter and noise settings, start and stop playing, and view results.

### ActiveX Methods Used

- [ConnectRP2](#)
- [Run](#)
- [GetSFreq](#)
- [ClearCOF](#)
- [Halt](#)
- [GetCycUse](#)
- [LoadCOF](#)
- [SetTagVal](#)
- [GetStatus](#)
- [GetTagVal](#)

### Files Used

The files required for this example can be found in:

*C:\TDT\ActiveX\ActXExamples\vc++\BandLimitedNoise*

- BandLimitedNoise.vcproj: Visual C++ project file
- BandLimitedNoiseDlg.cpp: Visual C++ code that controls the graphical user interface and communicates with the RpvdsEx circuit; contains an ActiveX component for the RP2
- BandLimitedNoise.exe: compiled executable; for running the example without having to start up Visual C++

The RpvdsEx file used can be found in: *C:\TDT\ActiveX\ActXExamples\RP\_files*

- Band\_Limited\_Noise.rcx: Control File of the RpvdsEx designed circuit

### Required Hardware

- RP2

### Required Applications

- RpvdsEx
- Visual C++

### Running the Application

- Run the BandLimitedNoise.exe executable file from the BandLimitedNoise directory, or load the BandLimitedNoise.vcproj project into Visual C++ and compile and run it from there.

### Making the RpvdsEx Circuit

#### *Required components:*

- Six parameter tags (ParTag). To change the name of a parameter tag, double-click the parameter and type a new name.
  - Gain - increases the relative bandpass filtering in dB

- Freq - center frequency of the bandpass filter
  - BW - width of the bandpass filter (3 dB rolloff)
  - Amp - changes the amplitude of the noise
  - Enable - toggles generation of the filter coefficients
  - Clip - checks to see whether the signal was clipped or not
- Gaussian noise generator (GaussNoise)
  - Parametric filter coefficient generator (ParaCoef)
  - Biquad filter (Biquad)
  - Feature search (FeatSrch)
  - Schmitt trigger (Schmitt)
  - Digital-to-analog converter (DacOut)
  - Digital bit output (BitOut)

Connect the circuit as shown below. The RPx online help is accessible from within RPsVsEx if it is required. The two boxes represent the different parts of the circuit.

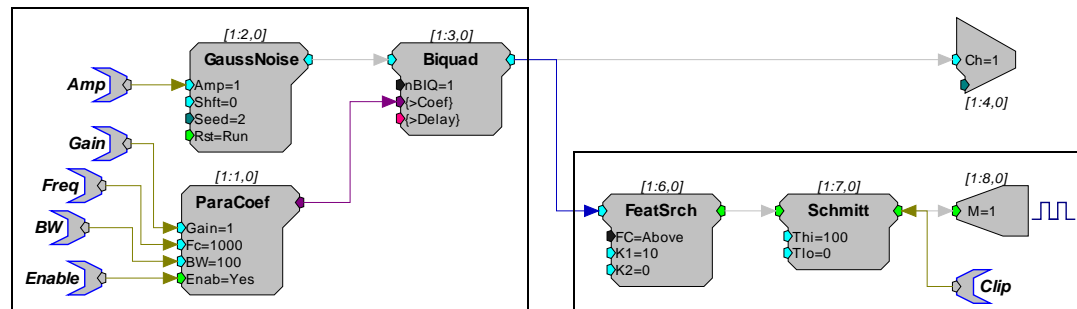

The box on the left has components that generate (GaussNoise) and filter (ParaCoef/Biquad) the waveform. The parameter tags are used to set the amplitude of the noise and filter parameters. The second part of the circuit (box on right) checks for clipping (signal values greater than +/- 10 volts) and generates a high signal on Bit 0 (M=1) of the processor device if clipping occurs.

### Program Description

The Visual C++ program controls a circuit that generates band-limited noise. Buttons allow the user to load the circuit and start and stop playing of the noise. Through input boxes, the user controls the center frequency, bandwidth, filter gain, coefficient generation, and the intensity of the filtered noise. The sample rate and cycle usage are displayed, along with a checkbox that is marked if the parameters produce clipping (values beyond +/- 10 volts). The relevant code controls or receives information about the circuit through parameter tags. An ActiveX control is used for the RP2 device.

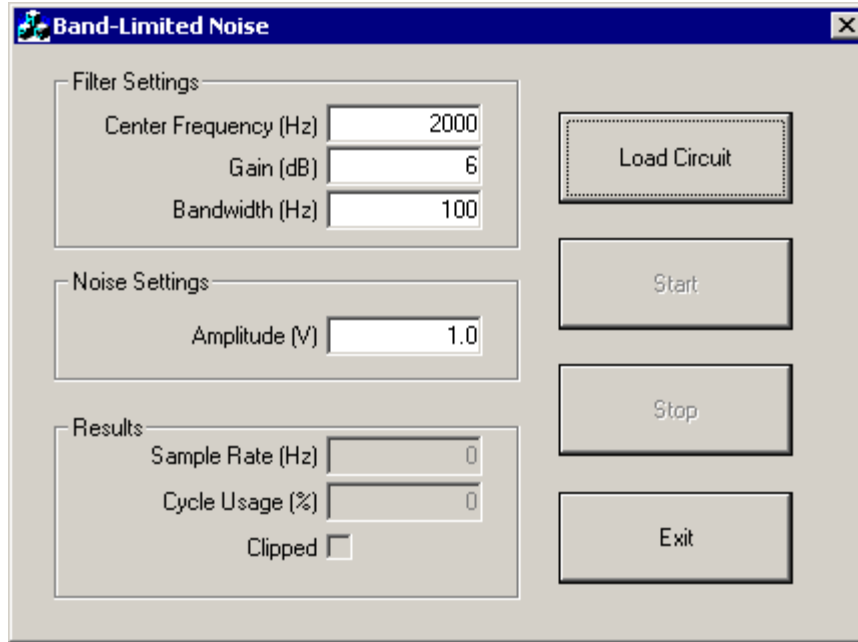

### Relevant Code

The code below is run when the user clicks the Load Circuit button. It connects to the RP2, loads the circuit, and makes sure everything was loaded successfully.

```

if (m_rp2.ConnectRP2("GB", 1) == 0)
    if (m_rp2.ConnectRP2("USB", 1) == 0) {
        AfxMessageBox("Error connecting to RP2.");
        return;
    }
m_rp2.ClearCOF();
if(m_rp2.LoadCOF("C:\TDT\ActiveX\ActXExamples\RP_files\Band_Limited_Noise.rcx") == 0) {
    AfxMessageBox("Error loading file");
    return;
}
// enable start button, disable stop button
m_start_button.EnableWindow(TRUE);
m_stop_button.EnableWindow(FALSE);

```

The code below is run when the user clicks the Start Circuit button. It sets the values of each parameter based on the values in the input boxes of the graphical interface. It then starts the circuit running, which plays the noise out of the RP2 on output channel number 1.

```

// set parameter values
UpdateData(TRUE);
m_rp2.SetTagVal("Amp", (float)atof(m_amplitude_text));
m_rp2.SetTagVal("Freq", (float)atof(m_centerfreq_text));
m_rp2.SetTagVal("BW", (float)atof(m_bandwidth_text));
m_rp2.SetTagVal("Gain", (float)atof(m_gain_text));
m_rp2.SetTagVal("Enable", (float)m_check_enable);
m_rp2.Run();
long status = m_rp2.GetStatus();
if (!(status && 4)) {
    AfxMessageBox("Error running circuit.");
    m_rp2.Halt();
}

```

## Visual C++ Example: Continuous Acquire

This example uses a circuit that continually acquires data from an input channel into a 100,000 sample serial buffer at a rate of 100 kHz and a Visual C++ program that continually reads from the serial buffer in blocks of 50,000 samples and saves the data to a file.

### ActiveX Methods Used

- [ConnectRP2](#)
- [Run](#)
- [GetTagVal](#)
- [LoadCOF](#)
- [Halt](#)
- [ReadTag](#)
- [GetStatus](#)
- [SoftTrg](#)

### Files Used

The files required for this example can be found in:

*C:\TDT\ActiveX\ActXExamples\vc++\ContinuousAcquire*

- ContinuousAcquire.vcproj: Visual C++ project file
- ContinuousAcquireDlg.cpp: Visual C++ code that controls the graphical user interface and communicates with the RPvdsEx circuit; contains an ActiveX component for the processor devices
- ContinuousAcquire.exe: compiled executable; for running the example without having to start up Visual C++

The RPvdsExfile used can be found in: *C:\TDT\ActiveX\ActXExamples\RP\_files*

- Continuous\_Acquire.rcx: Control File of the RPvdsEx designed circuit

### Required Hardware

- RP2

### Required Applications

- RPvdsEx
- Visual C++

### Running the Application

Run the ContinuousAcquire.exe executable file from the ContinuousAcquire directory, or load the ContinuousAcquire.vcproj project into Visual C++ and compile and run it from there. The program will produce an output file *C:\TDT\ActiveX\ActXExamples\VC++\fnoise2.f32*.

### Making the RPvdsEx Circuit

#### *Required components for acquisition:*

- Two parameter tags (ParTag). To change the name of a parameter tag, double-click the parameter and type a new name.
  - dataout - points to the memory buffer

- index - points to the index of the serial buffer
- Two software triggers (TrgIn, set to Soft1 and Soft2)
- Analog-to-digital converter (AdcIn)
- RS flip-flop (RSFlipFlop)
- Serial buffer (SerialBuf). To change the size of the serial buffer's memory, double-click the component and change the value for "Size" to 100000 (for this example)

Connect the circuit as shown below. The RPx online help is accessible from within RpvdsEx if it is required.

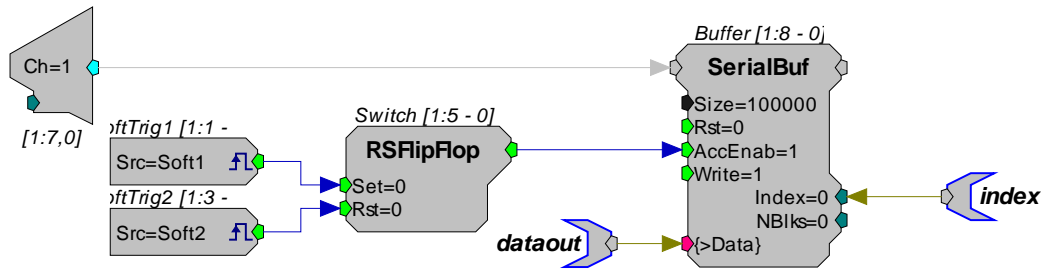

Data is continuously acquired on channel one but is only saved to the Serial buffer when the AccEnab line is set high. The two software triggers control the start and stop of the data acquisition. When Soft1 goes high the RSFlipFlop goes and stays high. This sets the AccEnab line high and the serial buffer starts saving the data. The serial buffer holds 100000 samples. When the buffer captures more than 100000 points the end of memory is reached, the index is reset to 0, and any data in memory is written over. When data cannot be downloaded to the PC fast enough it gets overwritten in the buffer.

To simulate real acquisition for this example, noise is played out on output channel 1 from the same circuit. This should be fed back in to input channel 1 to test acquisition.

### Program Description

The Visual C++ program controls the continuous acquisition circuit described above. The graphical interface to the program consists of buttons for loading the RpvdsEx circuit, starting acquisition, stopping acquisition, and exiting the program. The number of samples acquired and the current index of the serial buffer are displayed while acquisition is taking place. The data is written to an output file called "fnoise2.f32". An ActiveX control is used for the RP2 device. A timer is used to synchronize reading of data from the buffer.

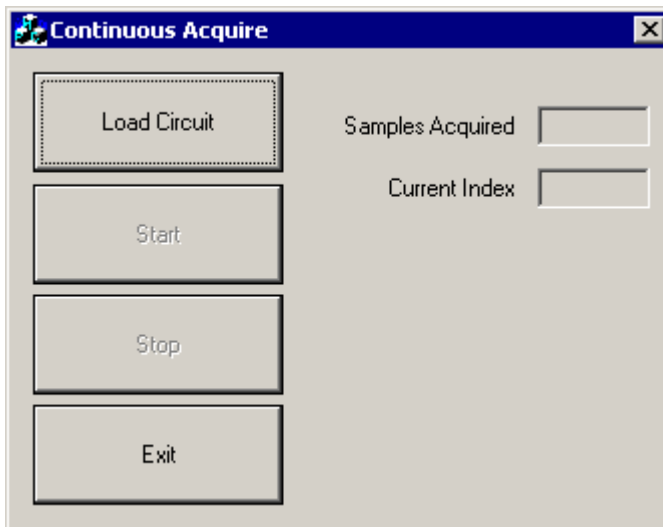

## Relevant Code

The code below is run when the user clicks the Start Acquire button. It enables the timer and performs a software trigger to start acquisition.

```
m_rp2.SoftTrg(1);
SetTimer(1, 10, NULL);
```

The code below is run when the acquisition timer goes off (every 10 ms). It alternates between reading from the first half of the buffer and the second half of the buffer. There is also code to check the data transfer rate and make sure it is keeping up with the acquisition input.

```
if(acquire) {
    curindex = m_rp2.GetTagVal("index");
    m_index_text.Format("%f", curindex);
    UpdateData(FALSE);
    if(high) {
        while(curindex > bufpts) {
            curindex = m_rp2.GetTagVal("index");
            m_index_text.Format("%f", curindex);
            UpdateData(FALSE);
        }
    }
}
else {
    while(curindex < bufpts) {
        curindex = m_rp2.GetTagVal("index");
        m_index_text.Format("%f", curindex);
        UpdateData(FALSE);
    }
}
// Read segment and write it to file
if(m_rp2.ReadTag("dataout", data, offset, bufpts) == 0)
    AfxMessageBox("Error transferring data.");
WriteToFile(data, bufpts);
samples_acquired += bufpts;
m_samples_text.Format("%d", samples_acquired);
UpdateData(FALSE);
```

## Visual C++ Example: Continuous Play

This example uses a circuit that continually plays to an output channel data from a 100,000 sample serial buffer at a rate of 100 kHz and a Visual C++ program that continually writes to the serial buffer in blocks of 50,000 samples.

### ActiveX Methods Used

- [ConnectRP2](#)
- [SoftTrg](#)
- [GetTagVal](#)
- [LoadCOF](#)
- [GetTagSize](#)
- [WriteTag](#)
- [Run](#)

### Files Used

The files required for this example can be found in:  
*C:\TDT\ActiveX\ActXExamples\vc++\ContinuousPlay*

- ContinuousPlay.vcproj: Visual C++ project
- ContinuousPlayDlg.cpp: Visual C++ form; includes graphical interface and VB code; contains an ActiveX component for the RP2
- ContinuousPlay.exe: compiled executable; for running the example without having to start up Visual C++

The RPvdsEx file used can be found in: *C:\TDT\ActiveX\ActXExamples\RP\_files*

- Continuous\_Play.rcx: Control File of the RPvdsEx designed circuit

### Required Hardware

- RP2

### Required Applications

- RPvdsEx
- Visual C++

### Running the Application

Run the ContinuousPlay.exe executable file from the ContinuousPlay directory, or load the ContinuousPlay.vcproj project into Visual C++ and compile and run it from there.

### Making the RPvdsEx Circuit

#### Required components for acquisition:

- Two parameter tags (ParTag). To change the name of a parameter tag, double-click the parameter and type a new name.
  - datain - points to the memory buffer
  - index - points to the index of the serial buffer
- Two software triggers (TrgIn, set to Soft1 and Soft2)
- Digital-to-analog converter (DacOut)
- RS flip-flop (RSFlipFlop)
- Serial buffer (SerialBuf). To change the size of the serial buffer's memory, double-click the component and change the value for Size to 100000 (for this example).

Connect the circuit as shown below. The RPx online help is accessible from within RPvdsEx if it is required.

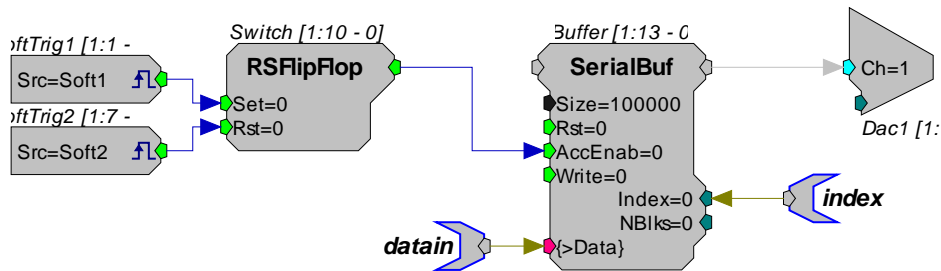

When software trigger 1 goes high the RSFlipFlop goes and stays high. This sets the AccEnab line high and the serial buffer starts sending the data out to the DAC. When the serial buffer has played out 100000 points the index is reset and the data at the beginning of the buffer is played out. As long as the AccEnab is high the Serial Buffer will play the signal.



## Program Description

The program plays a series of tones for 10 seconds. The first second of tones is loaded to the serial buffer. A software trigger starts the counter and the signal is played out through the DAC. The Serial buffer index is polled until 50,000 points are played from the buffer. Another tone is generated and loaded to the second half of the buffer. The counter is polled until the next 50,000 points are played out and the cycle is repeated. The program checks to see if the transfer rate is fast enough when the data is written to the buffer. A final software trigger ends the play out.

The interface to the program consists of only a single button, which starts the playing process. An ActiveX control is used for the RP2 device.

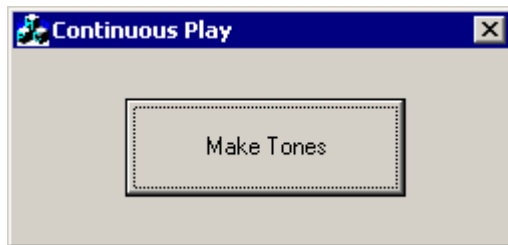

## Relevant Code

The code below contains the main playing loop. Each time through the loop, the tones are created at different frequencies. The first time through, the tones are written to the buffer immediately. Each time after that, the `sendtones()` function is called. The playing process is terminated by the software trigger 2.

```
// For each iteration, load tones into arrays and send
for (i = 0; i < num_iterations; i++) {
    freq1 += 500;
    freq2 += 500;
    for (int j = 0; j < bufpts; j++) {
        tone1[j] = (float) sin(2*PI*time[j]*freq1);
        tone2[j] = (float) sin(2*PI*time[j]*freq2);
    }
    if (i == 0) {
        // First time through
        m_rp2.WriteTag("datain", tone1, 0, bufpts);
        m_rp2.WriteTag("datain", tone2, bufpts, bufpts);
        m_rp2.SoftTrg(1);
    }
    else {
        SendTones(bufpts, tone1, tone2);
    }
}
// All done
m_rp2.SoftTrg(2);
m_rp2.Halt();
```

The code for the `sendtones()` function is shown below. It waits until the first half of the buffer is done playing, then writes the new tone to the first half of the buffer while the second half is being played. Then it ensures that the data was written to the buffer fast enough (otherwise the output is unreliable because the index buffer keeps looping continuously). After that, it waits until the second half is done playing, and then writes the new tone to the second half of the buffer. Again, the transfer rate is checked.

```
// Send first tone to first half of buffer
curindex = m_rp2.GetTagVal("index");
while (curindex < bufpts) {
    curindex = m_rp2.GetTagVal("index");
    sleep(20);
}
```

```

m_rp2.WriteTag("datain", tone1, 0, bufpts);
curindex = m_rp2.GetTagVal("index");
if (curindex < bufpts) {
    AfxMessageBox("Error: transfer rate too slow.");
    m_rp2.SoftTrg(2);
    return;
}
// Send second tone to second half of buffer
while (curindex > bufpts) {
    curindex = m_rp2.GetTagVal("index");
    sleep(20);
}
m_rp2.WriteTag("datain", tone2, bufpts, bufpts);
curindex = m_rp2.GetTagVal("index");
if (curindex > bufpts) {
    AfxMessageBox("Error: transfer rate too slow.");
    m_rp2.SoftTrg(2);
}

```

## Visual C++ Example: TDT ActiveX Console

This example documents a Visual C++ program that loads the Band\_Limited\_Noise.rcx control object file and runs it on the RP2 processor through the system console. This example illustrates how to create a formless application in Visual C++.

### ActiveX Methods Used

- [ConnectRP2](#)
- [LoadCOF](#)
- [ClearCOF](#)
- [Run](#)

### Files Used

The files required for this example can be found in:

*C:\TDT\ActiveX\ActXExamples\vc++\TDT\_ActiveX\_Console*

- TDT\_ActiveX\_Console.vcproj: Visual C++ project file
- TDT\_ActiveX\_Console.cpp: Visual C++ code that communicates with the RPsEx circuit; contains ActiveX components for the processor devices
- TDT\_ActiveX\_Console.exe: compiled executable; for running the example without having to start up Visual C++

### Required Hardware

- RP2

### Required Applications

- Visual C++

### Running the Application

Run the TDT\_ActiveX\_Console.exe executable file from the TDT\_ActiveX\_Console directory, or load the TDT\_ActiveX\_Console.vcproj project into Visual C++ and compile and run it from there.

## Program Description

The Visual C++ program loads the Band\_Limited\_Noise.rcx control file and runs it on an RP2 processor device. The system console is used to connect to the device through an initialization to the RPcoX ActiveX control. Once initialized, the ActiveX control is used to control the RP2 processor.

```

C:\TDT\ActiveX\ActXExamples\vc++\TDT_ActiveX_Console\TDT_ActiveX_Console.exe
Successfully initialized TDT ActiveX interface <d323a625-1d13-11d4-8858-444553540000>
C:\TDT\ActiveX\ActXExamples\RP_files\Band_Limited_Noise.rcx Loaded
Circuit running
Press Enter to halt circuit and exit

```

## Relevant Code

The code below is run when the user double clicks on the TDT\_ActiveX\_Console.exe executable file. It displays the system console and all connection information. Once the RPcoX ActiveX control has been initialized, the circuit can be loaded and run on the RP2 processor.

```

int _tmain(int argc, _TCHAR* argv[])
{
    const char* circuitPath =
        "C:\\TDT\\ActiveX\\ActXExamples\\RP_files\\Band_Limited_Noise.r
        cx";
    //Initialize ActiveX object
    HRESULT hr;
    hr = CoInitialize(NULL);
    if (FAILED(hr)) {
        printf("Failed to initialize COM!\n");
    }
    const char* appId= "{d323a625-1d13-11d4-8858-444553540000}";
    //"RPcoX.ocx"
    hr = RP.CreateInstance(appId);
    if (FAILED(hr)) {
        printf("CreateInstance for %s failed!\n", appId);
    }
    else {
        printf("Successfully initialized TDT ActiveX interface %s\n",
            appId);
    }
    if (0 == RP) return -1;
}

```



# Revision History

## **Version 7.3 – February 2012**

Addition of support for 64-bit operating systems

## **Version 7.1 – May 4, 2010**

Addition of support for the RZ6 Processor and ConnectRZ6 Method

## **Version 6.6 - August 15, 2007**

## **Version 6.4 - January 23, 2007**

## **Version 6.2 - September, 8, 2006**

## **Version 6.0 - January 18, 2006**

## **November 11, 2004 Version 5.8**

Addition of New ActiveX controls to support RXn devices:

ConnectRX5, ConnectRX6, ConnectRX7, and ConnectRX8

## **April 15, 2003 Version 5.0**

Addition of New ActiveX controls to support RMx devices:

ConnectRM1 and ConnectRM2

ActiveX Examples has been updated and expanded to include more Visual C++ examples.

## **February 8, 2002 Version 4.2**

Addition of Gigabit interface support and removal of XBUS interface support. See Connect device RPcoX. For how to connect to a device through the Gigabit interface.

## **January 8, 2002 Version 4.2**

Fixed errors in ActiveX help relating to zBUS ActiveX methods.

Addition of a QuickStart Guide.

Addition of New ActiveX control:

LoadCOFs: Allows users to select the sample rate of an rco(COF) file when the file is loaded.

## **August 8, 2001 Version 4.1**

ActiveX controls for the RPx families of devices.

ConnectRA16: Connects to the medusa amplifiers.

ConnectRV8: Connects to the Barracuda precision event timer.

GetDevCfg: Accesses Device settings for the Barracuda.

SetDevCfg: Sets the Device settings for the Barracuda.

## **ActiveX and MATLAB 6.0**

MATLAB 6.0 requires that all variables that are to be used in numerical operations be cast as Doubles. These operations include: +, -, \*, /, ^, ; and others. Compare statements such as <, >, == do not need the variable to be of type double. To change your MATLAB code to work with MATLAB 6.0 requires that you cast the variable is a DOUBLE. For example freq=invoke(RPx,'GetTagVal','freq') should be changed to freq=double(invoke(RPx,'GetTagVal','freq')) in MATLAB 6.0. Note that the above values work in MATLAB 5.3. Matlab 7 supports math on integer and single-precision data.

**March 5, 2001 Version 3.7**

**New Feature**

Stingray Reader. A program for acquiring data from your RPx device.

ActiveX controls for the RP family of devices

ConnectRL2: Connects to the RL2 (Stingray device)

ReadCOF: Maps the parameter tags and memory of an rco file for access by the PC. Used with portable RPx devices.

ActiveX: controls for the zBUS.

ConnectzBUS: Makes a connection between the PC and the zBus.

FlushIO: Flushes the data buffer on the zBus.

GetDeviceAddr: Gets the address of a device type.

GetDeviceAt: Gets the device type at a particular address.

GetDeviceVer: Gets the correct version of the devices microcode.

GetError: Returns an error string.

HardwareReset: Resets the Stingray and deletes any processing chain running on the system.

zBusTrigA/B: Triggers multiple zBus racks/RPx components simultaneously

zSync: Synchronizes the zBus clocks across several racks.

**Bug fixes**

zBusTrig fully functional

zSync fully functional

Problems with ReadTagVex

**Example Additions**

Detect Circuit for use with the Stingray.

**Sept. 05, 2000 Version 3.5**

Folder with ActiveX examples for MATLAB.

Revision of Connect method: Each member of the Real-time Processor family has its Connect method. Use ConnectRP2 to connect to an RP2. Device type is a String variable ("XBUS", "USB" etc...)

**New Methods:**

GetStatus: Used to check device status.

GetCycUse: Checks the cycle usage of the device.

GetNameOf: Returns the String ID of a component

GetNumOf: Returns the number of Components in the \*.rco file.

GetSFreq: Returns the sampling rate of the RP.

GetTagType: Determines the data type of the parameter tag.

GetTagSize: Returns the size of the data type.

ReadTagVEX: Reads data from a memory buffer and stores it in multiple data types and formats.

WriteTagVEX: Writes several types of formatted data to a memory buffer.

ZeroTag: Sets Parameter Tag values to zero.

# Known Anomalies

**Note:** Anomalies and tech notes are also available on the Web at:  
[www.tdt.com/T2Support/FlashHelp/System3TechNotes.htm](http://www.tdt.com/T2Support/FlashHelp/System3TechNotes.htm).

When using the GetStatus method with RX devices, the method returns erroneous values. RX devices return higher bit information and this causes issues with the status values described in the ActiveX help documentation. To access relevant status information in Matlab, use 'bitget' (or the equivalent in other programming languages) to read each bit directly.

e.g. `If all(bitget(RP.GetStatus,1:3));`

When using Delphi, ActiveX controls cannot be updated. Delphi remembers the older version of the ActiveX controls. To update to a new version of ActiveX controls, first uninstall the earlier version (i.e. remove it from the Delphi interface) and then install the new version.

Several errors occur when using ActiveX with MATLAB 6.0 and above. The main problem occurs when calling the invoke function, e.g. `status = invoke(RP, 'GetStatus');`. When using the return value of some of these calls, errors such as "function \_\_\_ not defined for variables of class 'int32'." result. To solve this problem cast the return values as doubles,

e.g. `status = double(invoke(RP, 'GetStatus'));`

Although ActiveX seems to connect and properly load a circuit to the RA16BA (Medusa Base Station), the GetStatus method will consistently return a 0 for connection status when a preamplifier is not properly connected to the base station. Connection Status is located in the least significant bit for the GetStatus command. When checking the status of the base station, ensure that the preamplifier is properly connected and turned on.

The zBusSync ActiveX Command is used for synchronizing caddies with USB1.1 (UZ1/UZ4) interfaces and should not be used with other types of interfaces.

Calling ReadTagV with Matlab 6.5 with the characters 'readtagv' (all lowercase) will cause a memory leak of 8 bytes per point returned. Calling GetTagVal with Matlab 7.0 with the characters 'gettagval' (all lowercase) will cause a memory leak of 40 bytes per function invocation.

Using the ActiveX methods ConnectRxx (e.g. ConnectRX6, ConnectRP2 etc.) more than once can sometimes cause a communication failure.

## **Version 57 or greater**

Invoking the ActiveX zTrigA or zTrigB calls always returns a zero, irrespective of the actual result.

HardwareReset returns a 0 if the hardware reset was performed successfully or not.





# Index

## A

ActiveX methods.. 37, 44, 59, 60, 61, 72, 74, 81  
MATLAB..... 37, 72, 73, 74, 76, 79, 81

## B

Battery .....42

## C

Channel .....81  
Clear .....37, 41, 72  
Connect ..... 27, 37, 42, 59, 72  
  ConnectRP2.....27, 37, 72  
  halt .....27, 41  
  Load Circuit.....27, 37, 42, 72  
  rco .....27, 37, 45, 47  
  Run..... 37, 40, 41, 42, 72  
  USB.....27  
  Xbus .....27  
  Zbus .....27  
  Device Status .....27  
Control Functions.....27  
Cycle Usage .....44, 73

## D

DAC .....79, 81  
Data and Parameters .....27  
  Array.....48  
  Ascii.....58  
  Buffers.....48, 49, 51, 52  
  Data Acquisition ..... 48, 49, 51, 52, 76  
  Data File.....81  
  Data Table.....81  
  Double Buffer ..... 48, 49, 51, 52, 76  
  Getting Data .....27, 51, 52  
  Parameter Tag . 27, 44, 45, 46, 47, 48, 49, 51, 52, 73, 74, 76, 79

GetTagVal..... 46, 51, 74, 76  
ReadTag ..... 27, 48, 49  
ReadTagV..... 27, 48, 49, 76  
SetTagVal ..... 27, 46, 74  
WriteTag ..... 51, 52  
WriteTagV..... 51, 52  
Play ..... 79  
Ram Buffer ..... 48, 49, 51, 52, 76, 79  
Send Data ..... 27, 51, 52, 58  
SendParTable ..... 27, 57, 81  
SendSrcFile..... 27, 58, 81  
String ID ..... 45, 46, 48, 49  
Wave File ..... 58

## E

Error Checking ..... 27, 37, 42, 44, 59, 60  
  GetError..... 60  
  Status ..... 60, 72

## F

Filter ..... 48, 49, 57, 58, 60, 74, 81  
FIR ..... 58, 81

## M

Mask ..... 42

## N

Noise ..... 74, 76, 81

## P

PA5 (See Programmable Attenuator) 59, 60, 61  
Programmable Attenuator..... 59, 60, 61  
  Attenuation ..... 59, 61, 62  
    Get Attenuation..... 59, 61, 62  
    Set Attenuation ..... 59, 62  
    SetAtten ..... 59  
Display..... 59, 60  
Front Panel..... 60, 62

Reset.....	59	Data type .....	47, 48, 49, 58, 73
Set User .....	62	GetCycUse .....	73
Base Attenuation .....	62	GetNameOf .....	44, 45, 46, 73
Dynamic Update .....	62	GetNumof .....	44, 45, 73
Manual Update .....	62	GetTagType .....	45, 46, 47, 51, 73
Minimum .....	62	RP2 (See Real-time Processor) ..	27, 37, 42, 44, 45, 46, 47
Reference .....	62	Rpvds .....	27, 37, 42, 44, 45, 46, 47
SetUser.....	59, 62	<b>S</b>	
Step Size .....	62	Signal .....	79, 81
Update .....	62	Soft Trigger .....	56, 76, 79
<b>R</b>		<b>T</b>	
Real-time Processor ..	27, 37, 42, 44, 45, 46, 47	Tone .....	79
Circuit ...	27, 37, 40, 41, 44, 45, 48, 49, 56, 73, 81	Trigger.....	56, 76, 79
Component type.....	45, 46, 73	<b>V</b>	
		VC++ ActiveX.....	18